

Indicator lamps and warning lamps	8	Online service.....	25
FAQ	10	Occupants safety	26
At a glance	13	Safety system	26
Interior	13	Overview of the safety system.....	26
Cockpit	13	Malfunctioning safety system	26
Warning lamps and indicator lamps	14	Functions of the safety system in an accident.....	26
Overhead control panel	16	Seat belts.....	28
Door control panel and seat adjustment.....	17	Protection provided by the seat belt.....	28
Exterior.....	17	Notes on the seat belts	28
Exterior equipment.....	17	Fastening the seat belts.....	29
Emergency and malfunction	18	Releasing a seat belt.....	30
General notes	19	Seat belt pretensioner	30
About this Manual	19	Seat belt load limit	30
Electronic User Manual	19	Second row seat belts.....	30
About the vehicle.....	19	Pregnancy safety	30
Environmental protection	19	Seat belt reminder	31
Take-back of end-of-life vehicles	19	Airbags.....	31
smart genuine parts	20	Overview of the airbags.....	31
Operating safety	20	Airbag warning notes.....	32
Diagnostics connection	21	Protection provided by the airbags	33
smart Authorized Service Partner	22	State of the passenger airbag.....	33
Vehicle registration	22	Enabling and disabling the passenger airbag.....	34
Correct use of the vehicle	22	Traveling safely with children in the vehicle.....	34
Information on the REACH regulation	22	Notes on traveling with children in the vehicle.....	34
QR code for rescue card.....	23	Detecting risks, avoiding dangers	35
Declaration of conformity.....	23	Suitability of the seats for attaching child restraint systems.....	37
Electromagnetic compatibility.....	23	Notes on installing a child restraint system.....	39
Radio equipment in the vehicle.....	23	Fitting an ISOFIX or an i-Size child restraint system	39
Data storage	24	Attaching TOP TETHER to the front passenger seat.....	40
EDR	24		
Vehicle data record	24		

Attaching TOP TETHER to the second row seat.....	40	Closing the liftgate.....	50
Installing seat belt-secured child restraint systems.....	41	Foot kick power liftgate.....	51
Notes on installing a child restraint system on the front passenger seat.....	42	Setting the liftgate opening angle.....	51
Child lock.....	42	Unlocking the liftgate mechanically.....	52
Traveling safely with pets in the vehicle.....	42	Windows.....	52
Notes on pets in the vehicle.....	42	Opening and closing the windows.....	52
<hr/>		Window anti-pinch.....	53
Opening and closing.....	44	Controlling the windows from the centre display.....	53
Key.....	44	Convenient opening.....	53
Overview of the key functions.....	44	Convenient closing.....	54
Find My Car.....	45	Problems with the windows.....	54
Enabling/Disabling Lock Sound.....	45	Anti-theft protection.....	54
Enabling/disabling Double Click Unlock.....	45	Anti-theft system.....	54
Removing and installing the mechanical key.....	45	Enabling/disabling the anti-theft protection.....	55
Replacing the keyfob battery.....	45	Disabling the triggered anti-theft alarm.....	55
Problems with the keys.....	46	Steering wheel lock (if equipped).....	55
Doors.....	47	Motion and tilting alarm (if equipped).....	55
Unlocking/opening the doors from inside.....	47	Vehicle intrusion alarm (if equipped).....	55
Unlocking/locking the vehicle from the central lock.....	47	<hr/>	
Unlocking/locking the vehicle with Keyless Entry.....	47	Seats and stowage.....	56
Approach to Unlock/Walk Away to Lock.....	47	Seats.....	56
Automatic lock on drive.....	48	Notes on the correct driver's seat position.....	56
Automatic unlock in case of emergency.....	48	Electrically adjusting the front seats.....	56
Automatic unlock when parked.....	48	Adjusting the 4-way lumbar support.....	57
Unlocking/locking the doors with the mechanical key.....	48	Folding/unfolding the second row seat backrests.....	57
Double Lock (if equipped).....	49	Head restraint.....	58
Liftgate.....	49	Setting Easy Entry/Exit.....	58
Opening the liftgate.....	49	Steering wheel.....	59
		Manually adjusting the steering wheel.....	59
		Memory function.....	59

Notes on memory function	59	Rear fog lamp	72
Seat memory function	60	Reversing lamp	72
Stowage space	60	Emergency brake light flash	72
Notes on loading the vehicle	60	Courtesy light	72
Interior stowage spaces	61	Interior lighting	73
Opening or closing the boot floor cover	62	Adjusting the interior lighting	73
Boot curtain	62	Adjusting the ambient lighting	74
Overview of the boot hooks	62	Windscreen wipers and washer system	74
Luggage retention buckle for boot	63	Operating the front wiper	74
Notes on the roof luggage racks	63	Operating the rear wiper	75
Sockets	63	Rear wiper auto activation setting	75
Using the 12 V power supply	63	Front wiper maintenance mode	75
USB	64	Replacing the front wiper blades	75
USB port	64	Replacing the rear wiper blade	76
Mobile phone wireless charging	64	Rearview mirrors	76
Notes on wireless charging	64	Adjusting the outside rearview mirrors	76
Charging the mobile phone wirelessly	65	Automatic anti-dazzle of the outside rearview mirrors	77
Floor mats	65	Manual anti-dazzle of the inside rearview mirror	77
Floor mats	65	Automatic anti-dazzle of the inside rearview mirror	77
<hr/>		Adjusting the inside rearview mirror manually	77
Light and vision	67	Outside rearview mirror heating	77
Exterior lighting	67	Outside rearview mirror folding	77
Information about the lighting system and your responsibilities	67	Angle down exterior mirrors when reversing	78
Light switch	67	Sunvisor	78
Operating the combination switch	67	Operating the sun visors	78
Turning on/off the hazard warning lights	68	<hr/>	
Illumination delayed turnoff	68	Climate control system	79
Approach lighting	68	Overview of the climate control system	79
Automatic turning on/off of the lighting	69		
Headlamp leveling adjustment	69		
Adaptive front illumination system	70		
Adaptive High Beam	71		
Automatic High Beam	71		

Physical buttons of the climate control.....	79	Vehicle discharging	89
Climate control interface on the centre display.....	79	Vehicle discharging port location.....	89
Operating the climate control system.....	79	Vehicle as power source	89
Turning on/off the climate control.....	79	Notes on using the vehicle as a power source	90
Setting the climate control to AUTO	79		
Adjusting the air flow direction	79	Driving and parking	91
Setting the air circulation mode.....	80	Driving.....	91
Front windscreen defrosting	80	Notes on electric vehicles	91
Rear windscreen defrosting.....	80	Notes on driving	91
Enabling/disabling the front seat heating.....	80	Winter driving	93
Enabling/disabling the front seat ventilation (if equipped).....	80	Recommended practices.....	93
Enabling/disabling the steering wheel heating (if equipped).....	81	Starting the vehicle	95
Climate control setting.....	81	Powering off the vehicle	95
Operating the climate control	81	Alcohol lock	96
Interior air quality system (if equipped).....	81	Energy Regenerative Braking.....	96
Air vents	82	Functions of s-Pedal.....	97
Armrest box ventilation.....	82	Drive modes.....	97
		Overview of the drive modes	97
		Selecting a drive mode.....	98
		Launch Control (if equipped).....	98
		Gear shift	99
		Steering column gear selector	99
		Parking	100
		Parking the vehicle.....	100
		Electric parking brake	101
		Parking assist	101
		Front parking assist.....	102
		Rear parking assist.....	103
		Automatic Parking Assist (APA)	103
		Parking in a parking space	104
		Parking Emergency Brake (PEB) (if equipped).....	105
		Driver assistance and driving safety system.....	105
		Driver assistance systems and your responsibilities.....	105
		Driver assistance system sensors.....	106
Vehicle charging and discharging	84		
Charging the high voltage battery	84		
Notes on high voltage battery charging	84		
Vehicle charging port and charging methods	85		
Travel schedule	85		
Function of the charging port indicator	87		
Start charging.....	87		
Stop charging.....	88		
Unlocking the charging gun in an emergency	88		







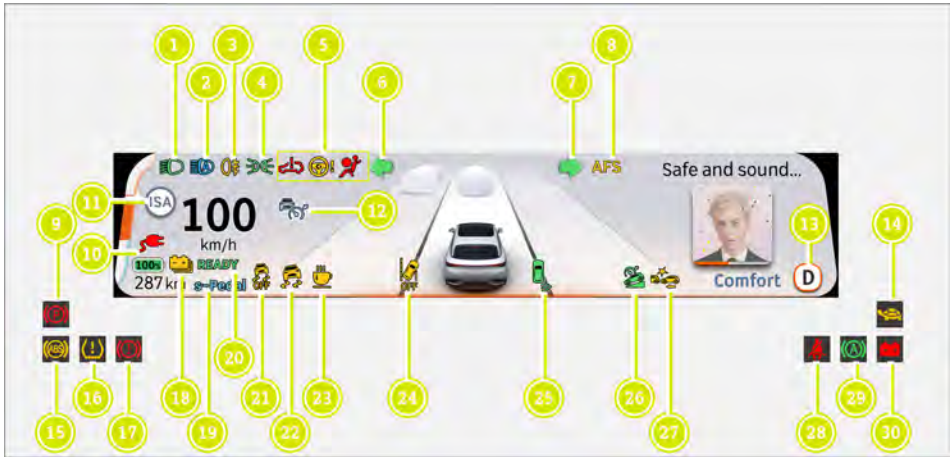





















Anti-lock Brake System (ABS)	107	Driver display	135
Electronic Brake Distribution (EBD)	107	Driver information display	135
Brake assist	107	Notes on the driver information display	135
Post Impact Braking (PIB)	107	Overview of the driver information display	135
Electronic Stability Control	108	Operating the driver information display	136
Electronic Stability Control Sport Mode	108	Warning lamps and indicator lamps	136
Park Assist 360 Camera	108	Head-up display	140
Power assisted steering	110	Notes on the head-up display	140
Autohold	110	Overview of the head-up display	140
Cornering Brake Control	110	Enabling/disabling the head-up display	141
Hill Assist	110	Enabling/disabling the snow mode	141
Hill Descent Control (HDC)	111	Adjusting the head-up display	141
Low speed warning	111	Centre display	143
Speed Limiting (LIM)	111	Overview and operation	143
Cruise Control (if equipped)	112	Notes on operating the centre display	143
Adaptive Cruise Control (ACC) (if equipped)	113	Overview of centre display	143
Highway Assist (HWA) (if equipped)	117	Overview of the steering wheel buttons	145
Traffic Jam Assist (TJA) (if equipped)	120	Shortcut interface	146
Lane Keeping Assist (LKA)	121	Shortcut interface	146
Lane Change Assist (LCA)	123	Function area	146
Automated Lane Change Assist (ALCA) (if equipped)	124	Message area	146
Front Collision Mitigation (FCM)	125	Mode selection area	147
Rear Collision Mitigation (RCM)	128	Ambient lighting theme selection area	148
Front Cross Traffic Alert (FCTA)	128	Setting interface	148
Rear Cross Traffic Alert (RCTA)	130	Overview of the setting interface	148
Door Opening Warning (DOW)	130	Quick controls	149
Evasive Maneuver Assist (EMA)	132	Ambient light	149
Traffic Sign Recognition (TSR) (if equipped)	132	Lights	150
Driver Monitoring System (DMS)	133	General	150

Driving assistance	151	Vehicle jump start	167
Vehicle settings	152	Vehicle transporting	168
Vehicle condition	153	Vehicle transportation	
System	153	methods	168
Privacy settings	154	Towing mode	168
Energy management	155	Fitting the tow bar	169
Overview of the energy			
management	155		
Charging and discharging	155		
Trip B	156		
Trip	156		
Navigation and traffic	157		
Navigation(if equipped)	157		
Multimedia	157		
Overview of multimedia	157		
Local radio	158		
Online radio/Online music	158		
Bluetooth music	159		
USB music	159		
Sound effects	160		
smart Companion	160		
Voice control	160		
Phone	160		
Phone	160		
Personal centre	161		
Personal centre function	161		
Smartphone integration	161		
Android Auto(If equipped)	161		
Apple CarPlay (if equipped)	163		
Breakdown assistance	165		
Emergency equipment	165		
Using a safety vest	165		
Warning triangle	165		
Fire extinguisher fitting			
point	165		
Fire extinguisher	165		
Flat tyre	166		
Stowage location of the tyre repair			
kit	166		
Tyre repair kit	166		
Jump start the vehicle	166		
Notes on jump start	166		
		Wheels and tyres	171
		Notes on the wheels and tyres	171
		Notes on noise or abnormal	
		handling	171
		Notes on regularly inspecting the wheels	
		and tyres	171
		Notes on snow chains	171
		Tyre pressure	172
		Notes on tyre pressure	172
		Tyre pressure table	173
		Tyre pressure monitoring	
		system	173
		Checking and correcting the tyre	
		pressure manually	174
		Replacing the Wheels and	
		tyres	174
		Notes on replacing the wheels and	
		tyres	174
		Notes on rotating the	
		wheels	176
		Notes on storing the wheels	176
		Tyre markings	176
		Seasonal tyres	177
		All season tyres	177
		Summer tyres	177
		Winter tyres	177
		Maintenance and care	178
		Lifting the vehicle	178
		Vehicle lifting points	178
		Front compartment	178
		Opening and closing the	
		bonnet	178
		Checking the coolant level	179
		Topping up the windscreen washer	
		system	180

Cleaning and care.....	181	Notes on the windscreen washer fluid	192
Notes on cleaning the vehicle.....	181	Refrigerant	193
Notes on using high pressure car wash	181	Vehicle parameters.....	194
Washing the vehicle manually	181	Vehicle dimensions.....	194
Notes on paintwork/matte finish paintwork care	182	Vehicle performance specifications.....	194
Notes on cleaning the decorative film	182	Suspension system specifications.....	195
Notes on external parts maintenance.....	183	Weight and payload	195
Notes on cleaning the interior	185	Battery specifications	196
Batteries	187	E-motor specifications	196
Notes on the 12 V battery	187	Brake system specifications	197
Start assist and charging the 12 V battery	188	Wheel dynamic balance requirement.....	198
Replacing the 12 V battery	188	Recommended tyre pressure	198
Notes on the high voltage battery	188	Seat specifications	198
Fuses	189		
Replacing fuses	189		
<hr/>			
Technical data	190		
Technical data description	190		
Technical data description	190		
On-board electronics.....	190		
Notes on unauthorized change of the motor and electronic equipment.....	190		
Vehicle identification plate, vehicle identification number (VIN) and E-motor serial number	190		
Vehicle identification plate.....	190		
Vehicle identification number (VIN).....	190		
E-motor serial number	191		
Operating fluids.....	192		
Note on the operating fluids.....	192		
Notes on the brake fluid	192		
Coolant	192		



- 1 Low beam on indicator lamp (green)
- 2 Low beam fault warning lamp (yellow)
- 3 High beam on indicator lamp (blue)
- 4 High beam fault warning lamp (yellow)
- 5 Automatic High Beam on indicator lamp/Adaptive High Beam ready indicator lamp (grey white)
- 6 Adaptive High Beam on indicator light (blue)
- 7 Automatic High Beam/Adaptive High Beam fault warning lamp (yellow)
- 8 Rear fog lamp on indicator lamp (yellow)
- 9 Position lamp on indicator lamp (green)
- 10 Powertrain fault warning lamp (red)
- 11 Electrical power assist steering (EPAS) - powered-assist steering performance decrease/power assist degraded warning lamp (yellow)
- 12 Electrical power assist steering (EPAS) - power assist fault - no power assist warning lamp (red)
- 13 Airbag fault warning lamp (red)
- 14 Trailer module fault indicator lamp (yellow)
- 15 Left turning signal indicator lamp (green)
- 16 Right turning signal indicator lamp (green)
- 17 AFS Adaptive front illumination system fault warning lamp (yellow)
- 18 Time display (20:24)
- 19 Electric parking brake enabled indicator lamp (red)
- 20 External charger/discharger connected warning lamp (red)
- 21 ISA fault indicator lamp (grey/white)
- 22 Speed Limit ready indicator lamp (grey white)
- 23 Speed Limit enabled indicator lamp (green)
- 24 Overspeed indicator lamp (yellow)
- 25 Adaptive Cruise Control ready indicator lamp (grey white)
- 26 Adaptive Cruise Control enabled indicator lamp (green)
- 27 Adaptive Cruise Control fault warning lamp (grey)
- 28 smart Pilot Assist ready indicator lamp (grey white)
- 29 Smart Pilot Assist ready indicator lamp (grey white)
- 30 Smart Pilot Assist ready indicator lamp (grey white)

-  smart Pilot Assist enabled indicator lamp (green)
-  smart Pilot Assist fault warning lamp (grey)
-  When the steering control is not activated, the steering wheel area is yellow
- 13  Current (P/R/N/D) gear indicator lamp (black)
- 14  Power restricted warning lamp (yellow)
- 15  Anti-lock Brake System fault indicator lamp (yellow)
- 16  Tyre pressure abnormal warning lamp (yellow)
- 17  Brake performance decrease/brake distance extended warning lamp (yellow)
-  Brake system fault warning lamp (red)
- 18  High voltage battery low indicator lamp (yellow)
- 19 s-Pedal standby indicator lamp (grey)
s-Pedal enabled indicator lamp (blue)
- 20  READY READY mode indicator lamp (green)
- 21  Electronic Stability Control off/Sport mode indicator lamp (yellow)
- 22  Electronic Stability Control fault warning lamp (yellow)
- 23  Driver Monitoring System indicator lamp fatigue warning (red flash)
-  Driver Monitoring System fault or camera blocked (yellow)
- 24  Lane Keeping Assist fault warning lamp (yellow)
-  Lane Keeping Assist or Lane Departure Warning disabled indicator lamp (yellow)
- 25  Rear Cross Traffic Alert/Door Opening Warning/Lane Change Assist on indicator lamp (green)
-  Rear Cross Traffic Alert/Door Opening Warning/Lane Change Assist fault indicator lamp (red)
- 26  Hill Descent Control ready indicator lamp (grey white)
-  Hill Descent Control enabled indicator lamp (green)
-  Hill Descent Control fault warning lamp (yellow)
- 27  Front Collision Mitigation fault warning lamp (yellow)
-  Forward Collision Warning/Autonomous Emergency Braking Off indicator light (yellow)
-  25° Display the outside temperature
- 28  Seat belt warning lamp (red)
- 29  Autohold indicator lamp (green)
- 30  12 V battery low indicator lamp (red)

The following questions are the ones you could encounter during vehicle daily use, and please contact a smart Authorized Service Partner if the content below cannot solve your question.

How do I start the vehicle?

1. Unlock the vehicle and open the driver door.
2. Press the brake pedal, and shift to drive **D** or reverse **R**, so the indicator lamp **READY** on the driver information display comes on, and the vehicle can run normally.

How do I jump start the vehicle?

If the vehicle requires to be jump started, refer to the topics related to jump start.

Notes on jump start (→ [Page 166](#)).

Jump start procedures (→ [Page 167](#)).

How to charge the high voltage battery?

When charging the high voltage battery, refer to the topics related to high voltage battery charging.

Notes on the high voltage battery charging (→ [Page 84](#)).

High voltage battery charging procedures (→ [Page 87](#)).

How to find a charging station quickly?

Open the navigation (if equipped) on the centre display and follow the navigation guidance.

How to solve tyre malfunctions?

When solving tyre malfunctions, refer to the topics related to tyre malfunctions.

Checking and correcting the tyre pressure manually (→ [Page 174](#)).

Tyre repair kit (→ [Page 166](#)).

When the punctures are within 6 millimeters and the outside temperature is above -20 °C, the tyre repair kit can be used.

How to transport the vehicle during breakdown?

When the vehicle needs to be transported during breakdown, refer to the topics related to vehicle transportation.

Activating the towing mode (→ [Page 168](#)).
Vehicle transportation methods (→ [Page 168](#)).

How to open damaged or frozen charging port cover?

Do not open the charging port cover by force to avoid component damage, and contact a smart Authorized Service Partner.

Can I top up with any type of coolant?

Not all types of coolant are suitable for this vehicle, and please go to a smart Authorized Service Partner if filling or replacing coolant is needed.

Can the vehicle be opened and started when the keyfob battery dies?

When the keyfob battery dies, you can open the vehicle door with the mechanical key.

1. Removing and installing the mechanical key (→ [Page 45](#)).
2. Unlocking/locking the doors with the mechanical key (→ [Page 48](#)).
3. Placing the keyfob in the armrest box, and starting the vehicle (→ [Page 95](#)).

Replacing the keyfob battery (→ [Page 45](#)).

If the vehicle still cannot be started, contact a smart Authorized Service Partner.

Welcome to smart

Before you first drive off, read this User Manual carefully and familiarise with your vehicle. For your own safety and a longer vehicle life, follow the instructions and warning notes in this User Manual. Disregarding them may result in damage to the vehicle or personal injury.

The configuration of your vehicle may vary from the description in this User Manual depending on the following factors:

- Model
- Order
- Market region

smart is continually working to develop its vehicles further.

The illustrations in this User Manual show a left-hand drive vehicle. On right-hand drive vehicles, the layout of components and control elements differs accordingly.

smart reserves the right to introduce changes in:

- Design
- Configuration
- Technical features

The actual configuration of your vehicle may be different from the description and illustration.

The printed documents are integral parts of the vehicle. Always keep these documents in the vehicle. If you sell the vehicle, always pass all documents on to the new owner.

Symbols

This User Manual includes the following symbols:

 **WARNING** Danger due to not observing the warning notes

Warning notes draw your attention to hazards that may endanger the health or life of you or others.

► Observe the warning notes.

 **NOTE** Damage to property due to failure to observe the notes on material damage

Notes on material damage remind you of risks which could lead to vehicle damage.

► Observe the notes on material damage.

 **ENVIRONMENTAL NOTE** Environmental damage due to failure to observe environmental notes

Environmental notes include information on environmentally responsible behaviour or disposal.

► Observe environmental notes.

 Useful instructions or further information that could be helpful.

(→ page) Further information on a topic

> Corresponding sub-menu to be selected in multimedia system

* Marks a cause.

Interior

Cockpit

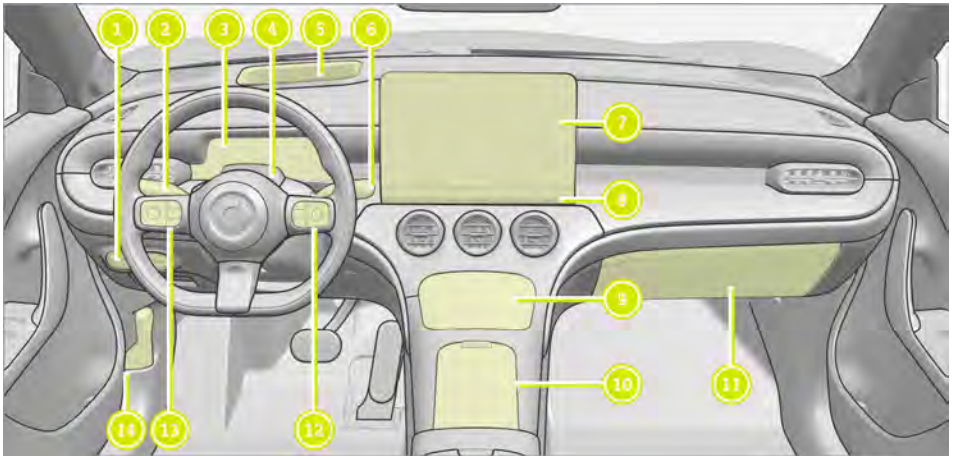



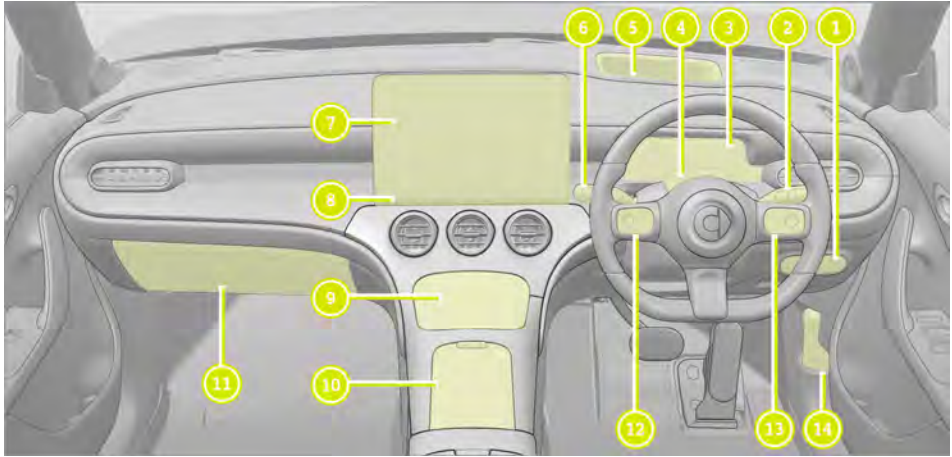





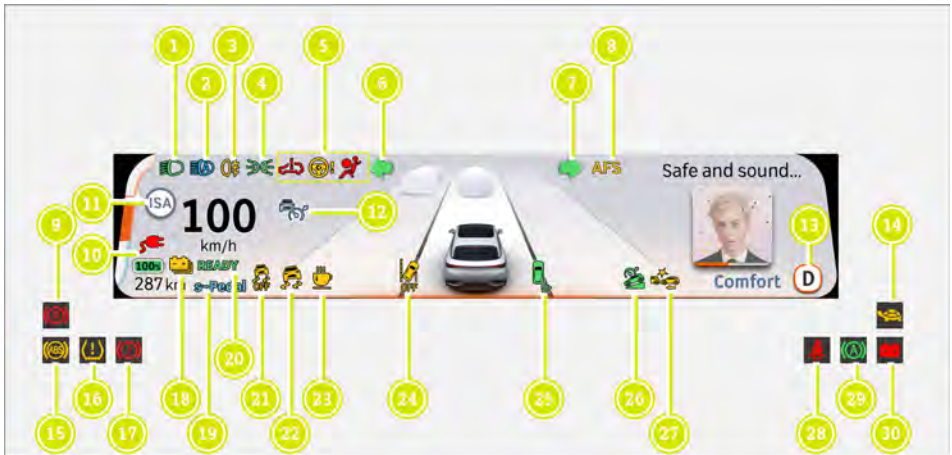

































- | | | | | | |
|-----------------------------------|---|-----|--|---|-----|
| 1 Light switch | → | 67 | 8 Centre display switches | → | 143 |
| Tailgate switch | → | 49 | 9 Centre console front storage box | → | 61 |
| 2 Light combination switch | → | 67 | 10 Centre console cup holders | → | 61 |
| Wiper control switch | → | 74 | 11 Glove box | → | 61 |
| 3 Driver information display | → | 135 | 12 Steering wheel right control button | → | 145 |
| 4 Driver status monitoring camera | → | 133 | 13 Steering wheel left control button | → | 145 |
| 5 Head-up display | → | 140 | 14 Open the bonnet | → | 178 |
| 6 Steering column gear selector | → | 99 | | | |
| 7 Centre display | → | 143 | | | |



















- | | | | |
|-----------------------------------|-------|--|-------|
| 1 Light switch | → 67 | 8 Centre display switches | → 143 |
| Tailgate switch | → 49 | 9 Centre console front storage box | → 61 |
| 2 Steering column gear selector | → 99 | 10 Centre console cup holders | → 61 |
| 3 Driver information display | → 135 | 11 Glove box | → 61 |
| 4 Driver status monitoring camera | → 133 | 12 Steering wheel left control button | → 145 |
| 5 Head-up display | → 140 | 13 Steering wheel right control button | → 145 |
| 6 Light combination switch | → 67 | 14 Open the bonnet | → 178 |
| Wiper control switch | → 74 | | |
| 7 Centre display | → 143 | | |

Warning lamps and indicator lamps



- 1  Low beam on indicator lamp (green)
-  Low beam fault warning lamp (yellow)
- 2  High beam on indicator lamp (blue)
-  High beam fault warning lamp (yellow)
-  Automatic High Beam on indicator lamp/Adaptive High Beam ready indicator lamp (grey white)
-  Adaptive High Beam on indicator light (blue)
-  Automatic High Beam/Adaptive High Beam fault warning lamp (yellow)
- 3  Rear fog lamp on indicator lamp (yellow)
- 4  Position lamp on indicator lamp (green)
- 5  Powertrain fault warning lamp (red)
-  Electrical power assist steering (EPAS) – powered-assist steering performance decrease/power assist degraded warning lamp (yellow)
-  Electrical power assist steering (EPAS) – power assist fault – no power assist warning lamp (red)
-  Airbag fault warning lamp (red)
-  Trailer module fault indicator lamp (yellow)
- 6  Left turning signal indicator lamp (green)
- 7  Right turning signal indicator lamp (green)
- 8  AFS Adaptive front illumination system fault warning lamp (yellow)
-  20:24 Time display
- 9  Electric parking brake enabled indicator lamp (red)
- 10  External charger/discharger connected warning lamp (red)
- 11  ISA fault indicator lamp (grey/white)
- 12  Speed Limit ready indicator lamp (grey white)
-  Speed Limit enabled indicator lamp (green)
-  Overspeed indicator lamp (yellow)
-  Adaptive Cruise Control ready indicator lamp (grey white)
-  Adaptive Cruise Control enabled indicator lamp (green)
-  Adaptive Cruise Control fault warning lamp (grey)
-  smart Pilot Assist ready indicator lamp (grey white)
-  smart Pilot Assist enabled indicator lamp (green)
-  smart Pilot Assist fault warning lamp (grey)
-  When the steering control is not activated, the steering wheel area is yellow
- 13  Current (P/R/N/D) gear indicator lamp (black)
- 14  Power restricted warning lamp (yellow)
- 15  Anti-lock Brake System fault indicator lamp (yellow)
- 16  Tyre pressure abnormal warning lamp (yellow)
- 17  Brake performance decrease/brake distance extended warning lamp (yellow)
-  Brake system fault warning lamp (red)
- 18  High voltage battery low indicator lamp (yellow)
- 19  s-Pedal standby indicator lamp (grey)
-  s-Pedal enabled indicator lamp (blue)
- 20  READY mode indicator lamp (green)

- 21  Electronic Stability Control off/
Sport mode indicator lamp (yellow)
- 22  Electronic Stability Control fault
warning lamp (yellow)
- 23  Driver Monitoring System indicator
lamp fatigue warning (red flash)
 Driver Monitoring System fault or
camera blocked (yellow)
- 24  Lane Keeping Assist fault warning
lamp (yellow)
 Lane Keeping Assist or Lane De-
parture Warning disabled indicator lamp
(yellow)
- 25  Rear Cross Traffic Alert/Rear Colli-
sion Mitigation/Door Opening Warning/
Lane Change Assist on indicator lamp
(green)
 Rear Cross Traffic Alert/Rear Colli-
sion Mitigation/Door Opening Warning/
Lane Change Assist on indicator lamp
(green)
- Lane Change Assist fault indicator lamp
(red)
- 26  Hill Descent Control ready indica-
tor lamp (grey white)
 Hill Descent Control enabled indi-
cator lamp (green)
 Hill Descent Control fault warning
lamp (yellow)
- 27  Front Collision Mitigation fault
warning lamp (yellow)
 Forward Collision Warning/Auton-
omous Emergency Braking Off indicator
light (yellow)
25° Display the outside temperature
- 28  Seat belt warning lamp (red)
- 29  Autohold indicator lamp (green)
- 30  12 V battery low indicator lamp
(red)

Overhead control panel

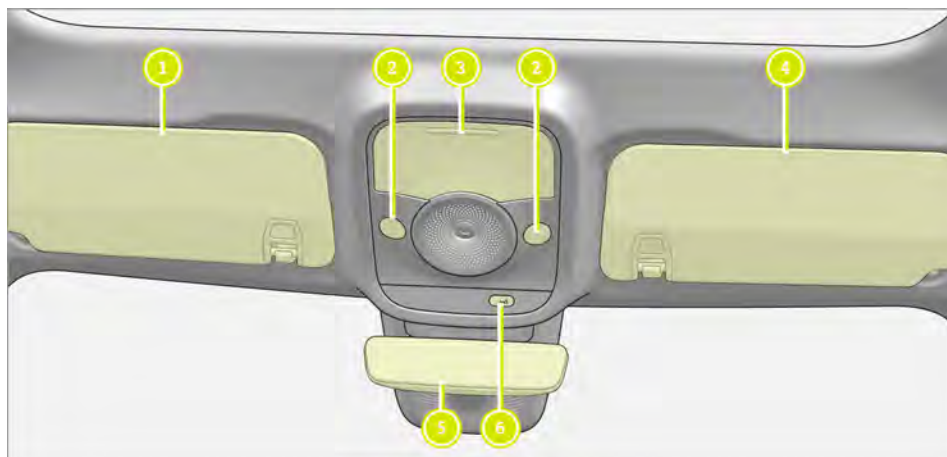

- 1 Left sun visor → 78
- 2 Front reading light → 73
- 3 Glasses box → 61
- 4 Right sun visor → 78
- 5 Inside rearview mirror → 77
- 6 SOS emergency call button (if equipped)

Door control panel and seat adjustment

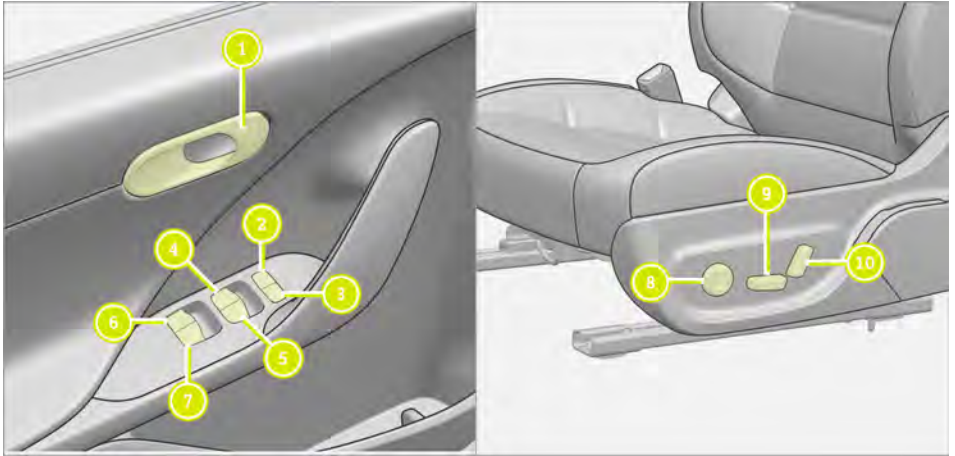

- | | | | | | | | |
|---|------------------------|---|----|----|----------------------------------|---|----|
| 1 | Door handle | → | 47 | 7 | Second row right window | → | 52 |
| 2 | Unlock the vehicle | → | 47 | 8 | Adjust the seat lumbar support | → | 57 |
| 3 | Lock the vehicle | → | 47 | 9 | Adjust the seat cushion position | → | 56 |
| 4 | Driver's window | → | 52 | 10 | Adjust the seat back position | → | 56 |
| 5 | Front passenger window | → | 52 | | | | |
| 6 | Second row left window | → | 52 | | | | |

Exterior

Exterior equipment

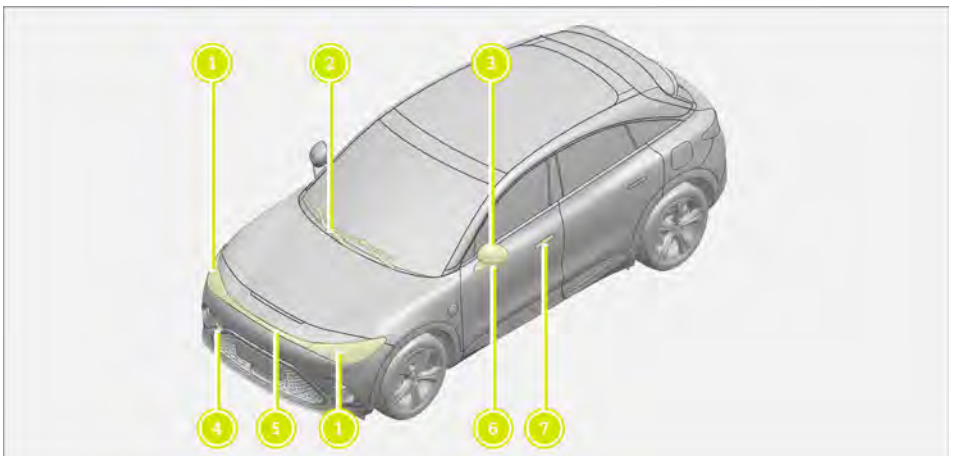

1 Lighting		3 Outside rearview mirrors	→ 76
High beam	→ 67	4 Front tow bar cover	→ 169
Low beam	→ 67	5 Middle position lamp	→ 67
Daytime running light	→ 67	6 Courtesy light	→ 72
Turning signal light	→ 67	7 Door handle	→ 47
2 Front wipers	→ 74		

Emergency and malfunction

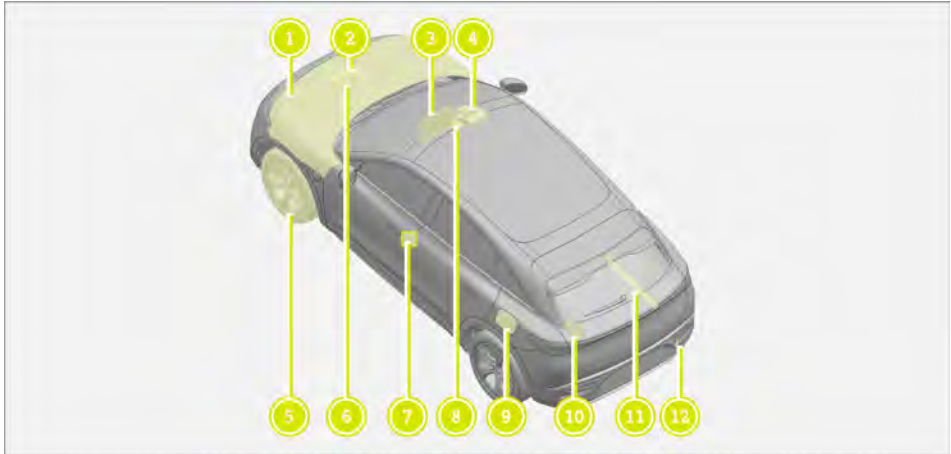

1 Operating fluids	→ 192	9 Charging cap with the following label	→ 85
2 Fitting the tow bar	→ 169	Charging warning label	→ 87
3 Hazard warning light	→ 68	QR code for rescue card	→ 23
4 SOS emergency call button (if equipped)		10 First aid kit	
5 Wheels and tyres	→ 166	11 Warning triangle	→ 165
6 Tyre repair kit	→ 166	12 Rear tow bar cover	→ 169
7 QR code for rescue card	→ 23		
8 Safety vest	→ 165		

About this Manual

Electronic User Manual

The electronic User Manual contains detailed description of the vehicle's functions and operation.

Note that your vehicle may not be fitted with all the features described. Therefore, the configuration of your vehicle may differ from the description and illustration in the User Manual, refer to the actual vehicle.

If you have any questions concerning configuration and operation, consult a smart Authorized Service Partner.

smart constantly improves its products and services and keeps updating the user manual from time to time. You can find the current version on the APP (if equipped) or smart local official website.

- ① The electronic version of the User Manual will be continuously updated and upgraded.

smart reserves the right to change the User Manual at any time.

About the vehicle

Environmental protection

- 🔥 **ENVIRONMENTAL NOTE** Environmental damage due to operating conditions and personal driving style

Drive the vehicle in an environmental responsible manner to protect the environment. Observe the following recommendations on operating conditions and personal driving style.

Operating conditions:

- ▶ Make sure that the tyre pressure is normal.
- ▶ Do not carry unnecessary loads (for example, do not carry child seats that are no longer needed).
- ▶ Monitor the energy consumption.
- ▶ Adhere to the service intervals.
- ▶ A regularly serviced vehicle will contribute to environmental protection.

Personal driving style:

- ▶ Drive carefully and maintain a suitable distance from the vehicle in front.
- ▶ Avoid frequent, sudden acceleration and braking.

- 🔥 **ENVIRONMENTAL NOTE** Environmental pollution caused by irresponsible disposal of batteries

Batteries contain substances harmful to the environment.

- ▶ Please go to a smart Authorized Service Partner to dispose of the damaged battery.

Take-back of end-of-life vehicles

smart takes back your end-of-life vehicle according to the relevant regulations and dispose it in an environment-friendly way.

A network of vehicle take-back and dismantling points has been established. You can leave the end-of-life vehicle at any of these points free of charge. This makes an

important contribution to improving the recycling circle and conserving resources.

For further information about the take-back of end-of-life vehicles, visit the smart Automobile official website or consult a local smart Authorized Service Partner.

smart genuine parts

! **NOTE** Damage to the operational performance of the safety system caused by accessories installation, repair or welding

Airbags and seat belt pretensioners, as well as control units and sensors for the safety system, may be installed in the following areas of your vehicle:

- Doors
- Door pillars
- Door sills
- Seats
- Headlamp brackets
- Cockpit
- Instrument cluster
- Centre console
- Lateral roof frame
- ▶ Never install accessories such as an audio system in these areas.
- ▶ Never carry out repairs or welding by yourself.
- ▶ Contact a smart Authorized Service Partner for modification accessories.

! **WARNING** Risk of accidents due to using parts which have not been approved by smart

Using parts which have not been approved by smart may jeopardise the operating safety of the vehicle and safety-related systems, like the brake system, and malfunction may occur.

- ▶ Please use smart genuine parts and accessories.

safety and suitability have been tested by smart.

smart accept no liability for the vehicle damage and personal injury caused by using non-smart genuine parts, even if they have been officially or independently approved by a third party test centre.

Always specify the vehicle identification number (VIN) when ordering smart genuine parts.

Operating safety

! **WARNING** Risk of accident due to malfunctions or system failures

If you do not have the prescribed service/maintenance or any required repairs carried out, system malfunctions or failures could occur.

- ▶ It is recommended to have the prescribed service/maintenance work as well as any required repairs carried out at a smart Authorized Service Partner.

! **WARNING** Risk of accident and injury due to modification to electronic components

Modification to electronic components, their related software or wiring could impair their function and/or the operation of other associated electronic parts, particularly systems related to safety. They may no longer function as intended and endanger the operating safety of the vehicle.

- ▶ Never tamper with the wiring, electronic components or their software.
- ▶ Please have the work related to electronic components carried out at a smart Authorized Service Partner.

For genuine parts and accessories (including conversion parts), their reliability,

⚠ WARNING Risk due to illegal modifications

Illegal modifications impair vehicle handling, safety and longevity, and may cause the vehicle no longer to be street legal.

- ▶ Check out the local regulations before modification. **smart is not responsible for any consequence caused by illegal modifications.**

! NOTE Damage to the vehicle

There is a risk of damage to the vehicle in the following situations:

- The vehicle body contacts the ground, such as a high kerb or when driving on an unpaved road.
- The vehicle is driven too fast over an obstacle, such as a kerb, speed bump or pothole.
- A heavy object strikes the underbody or chassis components.

In such situations, the body, the underbody, chassis components, high voltage battery, wheels or tyres could have suffered damages that are not visible. Components damaged in this way could fail unexpectedly or not function properly.

- ▶ Contact a smart Authorized Service Partner for inspection and repair immediately.

Electric vehicles are equipped with electric motors. The electric motor is powered by the high voltage electrical system.

⚠ WARNING Risk of fatal injury from touching damaged high voltage components

The vehicle high voltage electrical system is under high voltage. If you modify components in the vehicle high voltage electrical system or touch damaged components, electric shock may occur.

Components in the vehicle high voltage electrical system may suffer damage in an accident, although the damage may not be visible.

- ▶ Never modify the high voltage electrical system.
- ▶ Never touch components in the high voltage electrical system (for example: orange wiring harness and its connected components).
- ▶ After an accident, do not touch any high voltage components.
- ▶ After an accident, have the high voltage electrical system checked at a smart Authorized Service Partner.

The components of the high voltage electrical system are marked with yellow warning stickers. The cables of the high voltage electrical system are orange.



Electric vehicles generate significantly less noise than gas-powered vehicles. As a result, your vehicle may not be heard by pedestrians and other vehicles in certain situations. You are always responsible for driving the vehicle safely.

Diagnosics connection

The DLC is intended for the connection of diagnostic devices at a smart Authorized Service Partner.



▲ WARNING Risk of accident due to connecting devices to the diagnostics connection

If you connect equipment not approved by smart to the diagnostics connection in the vehicle, it may affect the operation of vehicle systems. As a result, the operating safety of the vehicle could be affected.

- ▶ Only connect the vehicle's diagnostics connection to devices which are approved by smart.

▲ WARNING Risk of accident due to objects in the driver's footwell

Objects in the driver's footwell may impede pedal travel or block a pressed pedal.

This jeopardises the operating and road safety of the vehicle.

- ▶ Stow all objects in the vehicle securely so that they cannot get into the driver's footwell.
- ▶ Always fix the floor mats securely in order to make sure that there is always sufficient room for the pedals.
- ▶ Never use loose floor mats, nor place a floor mat on another one.

smart Authorized Service Partner

smart authorized Service Partners have the necessary special skills, tools and qualifications to correctly carry out the work required on the vehicle, especially for safety-related works.

smart recommends that you bring your vehicle to a smart Authorized Service Partner for inspection and the following works:

- Safety-related work
- Maintenance
- Repair
- Modification and installation
- Electrical work

Vehicle registration

You can be informed about the vehicle inspections only if smart has your registration data.

In the following cases your vehicle may not be registered to you yet:

- If your vehicle was not purchased the official channel.
- If your vehicle has not yet been inspected at a smart Authorized Service Partner.

Use the smart APP or visit a smart Authorized Service Partner for information change.

Correct use of the vehicle

If you remove any warning stickers, you or others could fail to recognise certain dangers. Leave warning stickers in position.

Observe the following information particularly when driving your vehicle:

- The safety notes in this manual
- Technical data for the vehicle
- Traffic rules and regulations
- Laws and safety standards pertaining to motor vehicles

Information on the REACH regulation

The abbreviation REACH is short for Regulation concerning the Registration, Evaluation, Authorization and Restriction of Chemicals and it is part of the European Chemicals legislation. It entered into force in 2007 and aims to ensure a high level of protection of human health and the environment. At the same time it ensures the free circulation of chemicals on the internal market while enhancing competitiveness and innovation. The basic principle of

REACH is that producers, importers, and downstream users assume responsibility for their chemicals.

smart specially supports Regulation EC 1907/2006 Article 33 that relates to substances of very high concern.

Further information can be obtained at the following website:

<https://www.reach.smart.com>

QR code for rescue card

The QR code is on the inside of the charging port cover and on the driver side B-pillar. In the event of an accident or emergency situation, rescue services can use the QR codes to quickly find the appropriate rescue card for your vehicle. The current rescue card contains the most important information about your vehicle in a compact form, such as the routing of the electric lines.

Declaration of conformity

Electromagnetic compatibility

The electromagnetic compatibility of the vehicle components has been checked and certified according to the currently valid version of Regulation ECE R10.

Radio equipment in the vehicle

The following information is valid for all wireless components in the vehicle as well as the information systems and communication devices integrated in the vehicle:

This vehicle's wireless components meet the essential requirements and other relevant regulations stipulated in Directive 2014/53/EU and UK Radio Equipment Regulations 2017. Consult a smart Authorized Service Partner for detailed information.

Wireless applications

Item	Frequency range	Transmission output / magnetic field strength
CEM	134.2 KHZ \pm 0.1%	< 72 dBuA/m
Key PCBA	433.92 MHZ \pm 260 KHZ	-

Body domain control module

APTIV Electronics (Suzhou) Co, Ltd, No 123, Changyang Street, Suzhou Industrial Park, 215126 Suzhou, China

BJA

Continental Automotive GmbH, Siemensstrasse 12, D-93055 Regensburg, Germany

Key PCBA

smart Automobile Co. Ltd, 818 Binhai 2nd Road, Hangzhou Bay New Zone, 315336 Ningbo City, Zhejiang Province, China

BNCM 1

Continental Automotive GmbH, Siemensstrasse 12, D-93055 Regensburg, Germany

Hardware Assy - telematic node

Neusoft Group (Dalian) Co., Ltd, No. 901-7 Huangpu Road, Ganjingzi District, Dalian City, Liaoning Province, China

TPMS

Schrader Electronics Ltd, 11 Technology Park, Belfast Road, Antrim BT41 1QS, NorthernIreland

Radar - forward & rearward detection

Valeo Schalter & Sensoren GmbH, Laiernstrasse 12, 74321 Bietigheim-Bissingen, Germany

Radar - side obstacle detection

Valeo Schalter & Sensoren GmbH, Laiernstrasse 12, 74321 Bietigheim-Bissingen, Germany

FM2/DAB amplifier

Fuba Automotive Electronics GmbH, Tec Center, 31162 Bad Salzdetfurth, Germany

Item	Frequency range	Transmission output / magnetic field strength
BNCM 1	2400 MHz – 2483.5 MHz	2.5 dBm (antenna feed point)
TPMS	433.92 MHz	89 ± 3 dB V/m
Radar – forward & rearward detection	76 ~ 77 GHz	≤ 55 dBm peak e.i.r.p
Radar – side obstacle detection	76 ~ 77 GHz	≤ 55 dBm peak e.i.r.p
Wireless charger	100 KHz – 148.5 KHz	≤ 24 W
FM2/DAB amplifier	87 – 108 MHz 174 – 240 MHz	–

Data storage

EDR

A smart vehicle is equipped with an EDR system that meets the national standards. The system is used to record the relevant information when a vehicle collision event occurs, such as the vehicle speed (vehicle speed at the time of the event), braking state (whether the vehicle is braking at the time of the event).

The event data can help relevant personnel understand the state of the vehicle at the time of the event, so that relevant parties can act in accordance with relevant laws, regulations and provisions. In addition, this information can be used for engineering research, which help smart Automobile improve product quality and safety.

According to the requirements of national legislation and regulations, smart Automobile may need to disclose relevant recorded data to authorities such as the police department or other EDR system access authorised institutions. Reading the EDR system data requires special reader equipment from smart Automobile. Only individuals or organizations with authorization can access the data of the EDR

system. If necessary, you may consult a smart Authorized Service Partner and apply for this equipment with its help.

Vehicle data record

smart respects and is committed to protecting user's privacy. The information described in this manual is correct at the time of release. However as technology has been developed continuously, we recommend you to check out the latest information on the smart official website.

The vehicle is equipped with several storage devices to record specific data.

These storage devices do not record conversations or sounds. In some cases, they only record images outside the vehicle.

The data recorded may vary depending on the vehicle configuration. The recorded information normally includes vehicle conditions, maintenance requirements, events and malfunctions, etc.

The recorded information consists of, but not limited to, the following data:

- System component states, such as the battery state of charge and tyre pressure.
- Vehicle status, such as the vehicle speed, deceleration and lateral acceleration.

- Events and errors of essential systems, such as the headlamps and brake.
- System responses to driving situations, such as the airbag deployment and electronic stability control.
- Environment conditions, such as the temperature.

Data usage

We may use the data recorded in these storage devices for fault diagnosis, re-research, development and quality improvement.

Only under special occasions, some of the data when used in combination with other information, such as an accident report, vehicle damage or eyewitness statement, could be associated with a specific person.

We may disclose the recorded data to a third party in the following cases:

- With the consent of the owner or lessee (if it is a leased vehicle).
- As law enforcement, government authorities and third parties with lawful authority or through a legal process requested.
- Used by smart in the lawsuit.
- For research purposes, the data is not related to a particular vehicle or owner.

For more information, refer to the privacy policies in the centre display.

Online service

Wireless network connection

If your vehicle is equipped with a wireless network connection, data can be exchanged between the vehicle and other

equipment. The wireless network connection can be enabled through the transmission and reception unit of the vehicle or by connecting a mobile terminal equipment, such as a smart phone. Through wireless network connection, you can use online functions, including online services and applications provided by manufacturers or other service providers.

Services provided by the manufacturer

Regarding online services of the manufacturer, the individual functions are described by the manufacturer in a suitable place, such as the User Manual or website of the manufacturer, along with the relevant data protection information. Personal data can be used to provide online services. Data is exchanged via a secure connection, such as the manufacturer's designated IT systems. Collecting, processing and using personal data beyond the provision of services are permitted only on the basis of a statutory permit or declaration of consent.

Services from third parties

If online services are available from third parties, these services are the responsibility of the service providers and subject to that provider's data protection policies and terms of use. The manufacturer has no influence over the data exchanged in such cases.

For this reason, ask the service provider for information about the type, extent and purpose of the collection and use of personal data when services are provided by third parties.

Safety system

Overview of the safety system

The vehicle is equipped with multiple safety systems, which cooperate with each other to provide protection for vehicle occupants in case of an accident. Based on the accident, such as impact angle, roll-over or run off road, the safety system reacts differently to provide better protection.

The safety system includes the following components:

- Seat belts
- Airbags
- Child restraint system

In order for the safety system to provide the intended level of protection, vehicle occupants must observe the following:

- Fasten seat belts correctly.
- Sit in an almost upright position with the back against the seat backrest.
- Keep your feet on the floor.
- Children under 12 years old or 1.50 meters tall are recommended to use a suitable child restraint system. Always observe the local laws and regulations for the use of a child restraint system in the vehicle.

No safety system available today can completely eliminate injuries and fatalities in every accident situation. In particular, the seat belt and airbag generally do not protect occupants against objects penetrating the vehicle from the outside. It is also not possible to completely rule out the risk of injury caused by airbag deployment.

⚠ WARNING Risk of injury or death from modifications to the safety system

The safety system can no longer function correctly after alterations have been made.



The safety system may not protect the vehicle occupants as intended. For example, it may trigger unexpectedly or not trigger at all in an accident.

- ▶ Never alter the parts of the safety system.
- ▶ Never tamper with the wiring, electronic components and their software.

Malfunctioning safety system

When the vehicle is switched on, the indicators **READY** on the driver information display illuminate and the safety system performs self-diagnosis. During this process, the airbag malfunction lamp  illuminates and turns off shortly after the vehicle is switched on.

A malfunction has occurred in the safety system if:

- After the vehicle is switched on and the **READY** indicator on the driver information display illuminates, the airbag malfunction lamp  does not illuminate.
- The airbag malfunction lamp  illuminates continuously or repeatedly during a journey.

If a malfunction has occurred in the safety system, contact a smart Authorized Service Partner for inspection and repair immediately.

Functions of the safety system in an accident

Operation of the safety system depends on the detected collision strength and estimated accident type:

- Front collision
- Rear collision
- Side collision

The factors that can be seen and measured only after the collision cannot be used as the conditions for triggering airbag deployment, nor as the indications of airbag deployment.

Sometimes, airbags may not deploy even though serious deformation has been caused due to collision. For example, in case of deformation of a vehicle component which is subject to deformation easily and the vehicle deceleration is not high, the situation above may occur. On the contrary, the airbag may deploy even though the vehicle has slight deformation. For example, when colliding with the longitudinal beams and other rigid components and the vehicle deceleration is high enough, such circumstance may occur.

The safety system components may be triggered in case of some collision and impact or deceleration. It depends on the collision degree, angle, speed and object.

Equipment	Triggering conditions
Front airbag	In case of front collision accident and the airbag device reaches triggering conditions.
Side Airbag	Side collision or some high-speed frontal collision with an angle happens, and the airbag triggering conditions are met.

Equipment	Triggering conditions
Head air curtain	Side collision or some high-speed frontal collision with an angle happens, and the airbag triggering conditions are met.
Far side airbag	Side collision or some high-speed frontal collision with an angle happens, and the airbag triggering conditions are met.

The passenger airbag can be deployed in an accident only if the passenger airbag is enabled. If the front passenger seat is occupied, make sure both before and during the journey that the passenger airbag is in the correct state.

⚠ WARNING Risk of burns from hot airbag components

The airbag components are hot when just deployed.

- ▶ Do not touch the airbag components.
- ▶ Have deployed airbags immediately replaced at a smart Authorized Service Partner as soon as possible.

If the seat belt pretensioners are triggered or the airbags are deployed, you will hear a bang, and a small amount of powder may also be released.

- The bang sound generally does not affect your hearing.
- In general, the powder released is not hazardous to health but may cause short-term breathing difficulties to persons suffering from asthma or other pulmonary conditions.

- Provided it is safe to do so, leave the vehicle immediately or open the window in order to prevent breathing difficulties.

Seat belts

Protection provided by the seat belt

Always fasten your seat belt correctly before starting a journey. A seat belt can only provide the best level of protection if it is worn correctly.

Always observe the instructions about the correct driver's seat position and adjusting the seat (→ Page 56).

⚠ WARNING Risk of injury or death due to incorrectly fastened seat belt

A seat belt that is not worn correctly does not provide the intended level of protection. For example, personal injury may occur during an accident, emergency braking or steering.

- ▶ Always make sure that all vehicle occupants have their seat belts fastened correctly and sit properly.

For the correctly worn seat belt to provide the intended level of protection, vehicle occupants must observe the following:

- The seat belt must not be twisted. It must be inserted into its buckle correctly and fit tightly and snugly across the body.
- The seat belt must be routed across the centre of the shoulder and as low down across the hips as possible. Never route the lap belt across your abdomen. Pregnant women shall pay special attention to this.
- The shoulder section of the seat belt should not touch your neck nor be routed under your arm or behind your back.
- If not necessary, avoid wearing bulky clothing, such as a winter coat.
- Never route the seat belt across sharp, pointed, abrasive or fragile objects.

- Each seat belt shall only be worn by one person at any time. Never allow babies and children to travel sitting on the lap of another vehicle occupant.
- Never secure objects with a seat belt. If you need to secure objects, please observe Notes on loading the vehicle (→ Page 60).
- Also make sure that no objects, such as a cushion, are placed between the occupant and the seat.
- If there are children in the vehicle, please observe Notes on traveling with children in the vehicle (→ Page 34).

Notes on the seat belts

Always insert a seat belt tongue into its corresponding buckle, or the seat belt and the buckle may lose the intended function and lead to severe injury in the event of a collision.

⚠ WARNING Risk of injury or death due to incorrect seating posture

Incorrect seating posture may cause the airbag not to provide the intended level of protection, and its deployment may lead to other injuries.

To avoid risks, vehicle occupants must observe the following:

- ▶ Fasten seat belts correctly. Pregnant women must take particular care with this. Never route the lap belt across your abdomen.
- ▶ Make sure no people, animals or objects are ever placed between the airbag and the vehicle occupant.

⚠ WARNING Risk of injury or death when child restraint systems are not used for occupants with a smaller build

Children under 12 years old or 1.50 meters tall are recommended to use a suitable child restraint system and wear the integrated seat belt correctly.

An integrated seat belt that is not worn correctly does not provide the intended level of protection. For example, personal injury may occur during an accident, emergency braking or steering.

- ▶ Always secure children under 12 years old or 1.50 meters tall in a suitable child restraint system and wear the integrated seat belt correctly.

⚠ WARNING Risk of injury or death due to damaged or modified seat belts

Seat belts cannot provide the intended level of protection in the following situations:

- The seat belt is damaged, modified, extremely dirty, bleached or dyed.
- The seat belt buckle is damaged or extremely dirty.
- Modifications have been made to the seat belt pretensioners, seat belt anchorages or seat belt retractors.
- Seat belts may sustain non-visible damage in an accident from glass splinters.

Modified or damaged seat belts could tear or fail in the event of an accident.

Modified belt pretensioners may be triggered unintentionally or not function as intended.

- ▶ Never modify the seat belts, seat belt pretensioners, seat belt anchorages or seat belt retractors.
- ▶ Make sure that the seat belts are free of damage, not worn, and clean.
- ▶ After an accident, contact a smart Authorized Service Partner for safety system inspection and repair immediately.

⚠ WARNING Risk of injury or death from triggered seat belt pretensioners

Seat belt pretensioners that have been triggered are no longer operational and are unable to perform their intended protective function.

- ▶ Contact a smart Authorized Service Partner to have triggered seat belt pretensioners replaced immediately.

❗ NOTE Damage caused by unused seat belts being trapped

If an unused seat belt is not fully retracted, it may become trapped in the door or in the seat mechanism.

- ▶ Always make sure that unused seat belts are fully retracted.

Fastening the seat belts

If the seat belt is pulled quickly or sharply, the seat belt retractor locks and does not release the seat belt further.



1. Always insert a seat belt tongue **2** into the buckle **1** of the corresponding seat.
Pull the seat belt to make sure it is fastened correctly after hearing a "click" sound.
2. Press and hold the button on the seat belt height adjustment device **3** and adjust the device to the desired position.

3. Release the button on the seat belt height adjustment device **3** and make sure the device is locked in place.

Releasing a seat belt

Press the red button in the seat belt buckle and guide the seat belt back with the seat belt tongue.

Seat belt pretensioner

The front seat belts are equipped with pretensioners. In case of serious collision, the pretensioners trigger at the same time as the airbags. The pretensioners automatically tighten the seat belts, securing the occupants more effectively, thus reducing the forward inclination of the occupants.

The second row outboard seat belts are equipped with pretensioners to tighten the seat belts, thus reducing the forward inclination of the occupants.

If the pretensioners and airbags are not triggered during a collision, it does not mean that they have failed. It could be the intensity or the type of the collision does not meet the triggering conditions.

⚠ WARNING Risk of injury or death from triggered seat belt pretensioners

Once a seat belt pretensioner is triggered, it must be replaced. In the event of an accident, the airbags, seat belt pretensioners and other associated components may be damaged. Contact a smart Authorized Service Partner for inspection and repair.

Seat belt load limit

In case of serious collision, the seat belts can be pulled out slowly after the seat belts are pre-tightened or locked, which can reduce the seat belt pressure on the occupant's chest.

For vehicles equipped with seat belt adaptive load limit function, the seat belts can determine the switching time of the high and low force limits according to the size of the occupants. If it is determined that

the occupant is small, the low force limit can be switched on sooner to avoid excessive pressure on the occupant's chest. For a larger occupant, it will be switched on later.

Second row seat belts

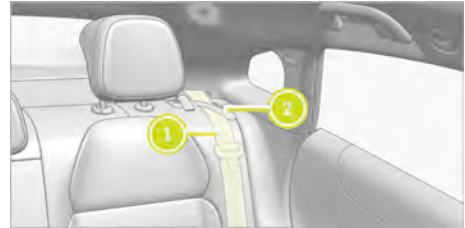

- 1 Second row seat belt
- 2 Seat belt strap retainer

The seat belt strap retainer on each of the second row outboard seat is there for the purpose of comfort. Users may choose to use them or not according to their needs.

- i Do not pull the seat belt strap retainer with force to prevent the strap retainer from falling off and the upholstery from being torn part, or the functionality of the strap retainer can be adversely affected.

Pregnancy safety

It is particularly important for a pregnant woman to wear the seat belt correctly.





Before operating the vehicle, a pregnant woman shall confirm with a doctor if she could drive a vehicle. To lower the risk of injury to you and your foetus, adjust the seat to stay away from the steering wheel, as long as you can still operate it normally.

Pass the shoulder strap through the shoulder, middle of the chest and to the side of the abdomen.

The lap belt part shall fit over the thighs and below the abdomen as much as possible. Do not raise the seat belt. Tighten the seat belt and make sure it fits the body closely. Make sure the seat belt is not twisted.

Seat belt reminder

The vehicle is equipped with a seat belt reminder function. The seat belt reminder warning lamp  on the driver information display is a reminder that all vehicle occupants must wear their seat belts correctly. In addition, a warning tone may sound. At the same time, the driver information display indicates the seat with the unfastened seat belt in the form of an image.

When the driver and the passenger do not wear the seat belt correctly, the seat belt reminder warning lamp  illuminates. When the vehicle speed exceeds about 10 km/h (7 mph) or after driving a certain distance forward, if the seat belt is not fastened, the seat belt reminder warning lamp flashes and sounds a warning tone until the seat belt is fastened.

If the vehicle is driving forward at more than 10 km/h (7 mph) and the seat belt is unfastened, the seat belt unfastened warning indicator lamp  flashes with a warning tone until the seat belt is fastened again.

Airbags

Overview of the airbags

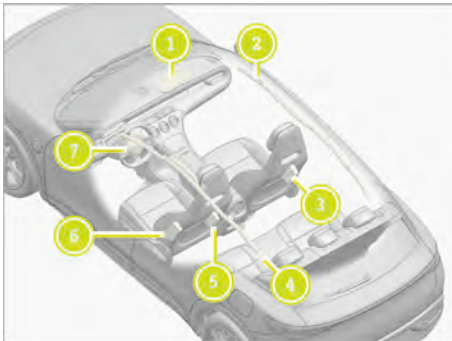

- 1 Passenger airbag
- 2 Right air curtain
- 3 Front side airbag
- 4 Left air curtain
- 5 Far side airbag
- 6 Front side airbag
- 7 Driver's airbag

The installation location of an airbag is indicated by the AIRBAG symbol.

An airbag may provide supplementary protection for the corresponding vehicle occupant.

Passenger airbag label

⚠ WARNING Risk of injury or death from deployed airbags

A deployed airbag no longer offers any protection and cannot provide the intended protective function in the event of an accident.

- ▶ Contact a smart Authorized Service Partner to have deployed airbags replaced.



The label is visible on the passenger side B pillar when the front passenger door is opened.



The passenger airbag label is located on the front passenger sun visor.

Airbag warning notes

Each vehicle occupant must observe the following information to prevent risks caused by deploying airbags:

- Adjust the seat correctly before driving. Try to move the driver seat and the front passenger seat backward as much as possible if appropriate. Before proceeding with the operation, observe the relevant notes on the correct driver's seat position (→ Page 56).
- Hold the steering wheel correctly to make sure complete deployment of airbags.
- Make sure to rest on the seat backrest during driving. Do not lean forward. Do not lean against the door or window. Otherwise, you may be in the airbag deployment area.
- Keep your feet on the floor. Never put your feet on the dashboard. Otherwise, your feet may be in the airbag deployment area.
- If there are children in the vehicle, please observe Notes on traveling with children in the vehicle (→ Page 34).
- Be sure to store and secure objects correctly and observe Notes on loading the vehicle (→ Page 60).

Objects may hinder normal operation of airbags, each vehicle occupant must observe the following:

- There are no persons, animals or objects between the occupant and airbag.
- There are no objects between the seat, door and door pillar (B-pillar).
- There are no hard objects, such as coat hanger, on the handle or the coat rack.
- There are no mobile navigation equipment, mobile phones, cup holders, etc. in the airbag deployment area of the vehicle (e.g. cabin, door, window or side trim panel).
Never fix connecting cables and tie-down belts in or to the airbag deployment area.

- The occupant's pocket shall be free from any heavy, sharp or fragile object. Place these objects at appropriate positions.

⚠ WARNING Risk of injury caused by modifying airbag covers

If airbag covers are modified or stucked with labels and other objects, the airbags may not be able to function normally.

- ▶ Never modify airbag covers or stick objects onto them.

⚠ WARNING Risk of injury or death caused by seat covers

Seat covers may hinder or prevent airbags from deploying, and as a result the airbags cannot provide the intended level of protection for occupants.

- ▶ Do not use seat covers on the first row seats.

⚠ WARNING Risk of injury caused by door pressure sensor failure

The doors have door pressure sensors to control airbags. Modifying or implementing incorrect operation on doors, door decoration boards and damaged doors may impair the sensor function. As a result, the airbags may not be able to function normally and provide the intended level of protection for occupants.

- ▶ Do not add or modify doors or door components by yourself.
- ▶ Contact a smart Authorized Service Partner for the related work.

▲ WARNING Risk of injury or death from deployed airbags

A deployed airbag no longer offers any protection and cannot provide the intended protective function in the event of an accident.

- ▶ Contact a smart Authorized Service Partner to have deployed airbags replaced.

Protection provided by the airbags

Depending on the accident situation, an airbag may supplement the protection offered by a correctly fastened seat belt.

▲ WARNING Risk of injury or death due to incorrect seating posture

Incorrect seating posture may cause the airbag not to provide the intended level of protection, and its deployment may lead to other injuries.

To avoid risks, vehicle occupants must observe the following:

- ▶ Fasten seat belts correctly. Pregnant women must take particular care with this. Never route the lap belt across your abdomen.
- ▶ Make sure no people, animals or objects are ever placed between the airbag and the vehicle occupant.

Possible protection from each airbag:

Airbags	Possible protection for
Driver's airbag, front passenger airbag	Head and thorax
Side curtain airbag	Head
Front side airbag	Thorax
Far side airbag	Head and thorax

State of the passenger airbag

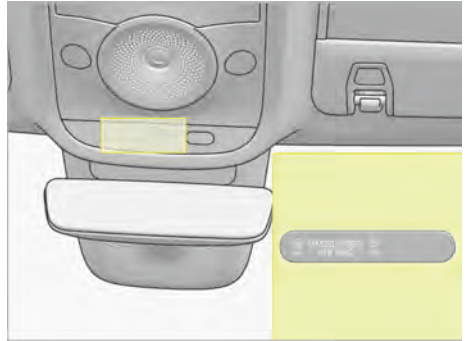

Passenger airbag disabled: OFF

Passenger airbag enabled: ON

The passenger airbag can be deployed in an accident only if the passenger airbag is enabled. If the front passenger seat is occupied, make sure both before and during the journey that the passenger airbag is in the correct state.

▲ WARNING Risk of injury or death if the passenger airbag is disabled

If the PASSENGER AIRBAG OFF indicator lamp illuminates, it means that the passenger airbag is disabled, which will not deploy in case of accident and cannot provide necessary protection.

In this case, if the front passenger sits too close to the front, serious injury or death may occur.

If the front passenger seat is occupied, make sure:

- The passenger airbag is enabled or disabled in accordance with the type of the passenger on the front passenger seat.
- The passenger sits correctly.
- ▶ Make sure both before and during the journey that the status of the front passenger airbag is correct.

⚠ WARNING Risk of injury or fatal injuries if the front passenger airbag is enabled

The child on the front passenger seat may be struck by the airbag in the event of an accident if the front passenger airbag is enabled.

- ▶ Never use a rearward-facing child restraint system on a seat protected by an active airbag in front of it, death or serious injury to the child can occur.

Enabling and disabling the passenger airbag

The vehicle is equipped with a passenger airbag switch to disable the passenger airbag.

The front passenger airbag switch is located on the passenger end of the dashboard and is accessible when the front passenger door is opened.

Check if the switch is in the desired position.

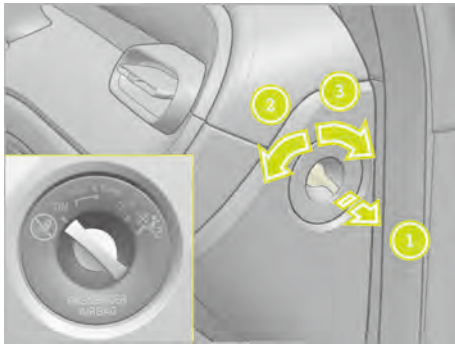

To enable the passenger airbag: pull the switch **1** in the direction of the arrow and rotate the switch counter-clockwise **2** to enable the passenger airbag.

To disable the passenger airbag: pull the switch **1** in the direction of the arrow and rotate the switch clockwise **3** to disable the passenger airbag.

Traveling safely with children in the vehicle

Notes on traveling with children in the vehicle

Observe the safety notes relevant to the situation. You have to identify possible risks and avoid dangers when children are traveling in the vehicle (→ Page 35).

Be alert

Bear in mind that negligence when securing a child in a child restraint system may have serious consequences. Always be alert and secure a child carefully before each journey.

To improve protection for children under 12 years old or 1.5 meters tall, smart recommends you observe the following:

- Always secure the child in a child restraint system suitable for your vehicle.
- The child restraint system must be appropriate to the age, weight and size of the child.

Statistics show that it is usually safer to install the child restraint system in a second row seat than in the front passenger seat. It is recommended to install the child restraint system to the second row seat.

A child restraint system is, for example:

- A rearward-facing child seat
- A forward-facing child seat
- A child booster seat with a backrest and seat belt guides

Observe laws and regulations

Always observe the local legal requirements for using a child restraint system in the vehicle.

⚠ WARNING Notes on child restraint system

The contents of this manual are applicable to areas where there are no laws and regulations on the installation and use of a child restraint system.

- ▶ In addition to the installation instructions and operation manual, observe local laws and regulations for the installation and use of a child restraint system.
- ▶ In any area where laws and regulations have been made on the installation and use of a child restraint system, if any relevant content of this manual is inconsistent with the local laws and regulations, the local laws and regulations shall prevail.

Detecting risks, avoiding dangers

Securing systems for child restraint systems in the vehicle

Only use the following securing systems for the child restraint systems:

- ISOFIX/i-Size fixing point
- The vehicle's seat belt system
- TOP TETHER anchorages

When the child is secured using the safety belt integrated in the ISOFIX/i-Size child restraint system, observe the maximum permissible weight and stature of the child and child restraint system together.

The advantage of a rearward-facing child restraint system

Toddlers or infants should preferably travel in a suitable rearward-facing child restraint system, so that they are seated in the opposite direction of travel and facing backward.

Babies and infants have comparatively poorly developed neck muscles and a rearward-facing child restraint system can reduce the risk of injury to the cervical spine in an accident.

Secure the child restraint system correctly at all times

⚠ WARNING Risk of injury or death caused by incorrect installation of the child restraint system

If the child restraint system is incorrectly installed on a suitable seating position, it cannot perform its intended protective function.

The child cannot be restrained in the event of an accident, heavy braking or a sudden change of direction.

- ▶ Always observe the installation instructions and operation manual provided by the manufacturer for the child restraint system being used.
- ▶ Make sure that the entire base of the child restraint system always rests on the sitting surface of the seat.
- ▶ Never place objects, such as cushions, under or behind the child restraint system.

⚠ WARNING Risk of injury or death from unsecured child restraint systems in the vehicle

If the child restraint system is not correctly installed or secured, it could release in the event of an accident, sudden braking or a sudden change in direction.

The child restraint system could be tossed around and hit the occupants inside the vehicle.

- ▶ Always fit child restraint systems correctly, even when not in use.
- ▶ Always observe the installation instructions and operation manual provided by the manufacturer for the child restraint system being used.

- Observe the instructions of warning labels in the vehicle interior and on the child restraint system.
- Attach the TOP TETHER.

Never alter the child restraint system

⚠ WARNING Risk of injury due to alterations to the child restraint system

The child restraint system may no longer function as it is supposed to if alterations are made or objects are attached to it, such as toys or unsuitable accessories. This poses an increased risk of injury!

- ▶ Never alter the child restraint system.

Only use child restraint systems which are not damaged

⚠ WARNING Risk of injury or death caused by the use of damaged child restraint systems

Child restraint systems or their retaining systems that have been subjected to a load in an accident may then not be able to perform their intended protective function.

The child may not be restrained in the event of an accident, heavy braking or a sudden change of direction.

- ▶ Always replace child restraint systems immediately that have been damaged or involved in an accident.
- ▶ Contact a smart Authorized Service Partner to have the retaining systems for the child restraint systems checked before installing a child restraint system again.

Avoid direct sunlight

⚠ WARNING Risk of burns when the child restraint system is exposed to direct sunlight

If the child restraint system is exposed to direct sunlight, components could heat up.

Children could suffer burns on these components, particularly on metallic parts of the child restraint system.

- ▶ Make sure that the child restraint system is not exposed to direct sunlight.
- ▶ If the child restraint system has been exposed to direct sunlight, allow it to cool before securing a child into it.
- ▶ Never leave children unattended in the vehicle.

Observe the following when stopping or parking

⚠ WARNING Risk of accident and injury due to children left unattended in the vehicle

If children are left unattended in the vehicle, they could in particular:

- Open doors, thereby endangering other persons or road users.
- Get out and be struck by oncoming traffic.
- Operate vehicle equipment and become trapped.

In addition, children could also set the vehicle in motion, by in particular:

- Releasing the parking brake
- Shifting the gear
- Starting the vehicle
- ▶ Never leave children unattended in the vehicle.
- ▶ When leaving the vehicle, always take the key with you and lock the vehicle.
- ▶ Keep the key out of the reach of children.

⚠ WARNING Risk of fatal injury due to exposure to extreme heat or cold in the vehicle

If people, particularly children, are exposed to extreme temperatures over an extended period of time, there is a risk of serious or even fatal injury!

- ▶ Never leave anyone, particularly children, unattended in the vehicle.
- ▶ Never leave animals in the vehicle unattended.

Suitability of the seats for attaching child restraint systems

When using a child restraint system on the front passenger seat, observe the following:

- The passenger airbag must be deactivated when using a rearward-facing child restraint system. Once the rearward-facing child restraint system is

removed, activate the passenger airbag immediately.

- If possible, adjust the front passenger seat backrest vertically to ensure secure contact between the backrest and the child restraint system.
- Try adjusting the seat position when the backrest of the child restraint system does not fit the shape of the seat during child restraint system installation on the front passenger seat.
- When installing with a seat belt, adjust the height of the front passenger seat as much as possible to ensure correct installation of the child restraint system.
- Adjust the height of the front passenger seat belt to make sure the seat belt does not kink or bent over the edge of the guide device as it passes through the guide device.

Seating position

seating position	front right						
	front left	front centre	with front passenger airbag activated	with front passenger airbag deactivated	2nd row left	2nd row centre	2nd row right
Seating position suitable for universal belted (Yes/No)	No	No	Yes Forward facing only	Yes	Yes	Yes	Yes
I-Size seating position (Yes/No)	No	No	Yes Forward facing only	Yes	Yes	No	Yes
Seating position	No	No	No	No	No	No	No

seating position	front right						
	front left	front centre	with front passenger air-bag activated	with front passenger air-bag deactivated	2nd row left	2nd row centre	2nd row right
suitable for lateral fixture (L1/L2)							
Largest suitable rearward facing fixture (R1/R2X/R2/R3)	No	No	No	R1/R2X/R2/R3	R1/R2X/R2/R3	No	R1/R2X/R2/R3
Largest suitable forward facing fixture (F2X/F2/F3)	No	No	F2X/F2/F3	F2X/F2/F3	F2X/F2/F3	No	F2X/F2/F3
Largest suitable booster fixture (B2/B3)	No	No	B2/B3	B2/B3	B2/B3	B2/B3 Seatbelt only	B2/B3

ISOFIX child restraint system size envelope fixtures:

- ISO/F3: Full-Height Forward Facing toddler CRS
- ISO/F2: Reduced-Height Forward Facing toddler CRS
- ISO/F2X: Reduced-Height Forward Facing toddler CRS
- ISO/R3: Full-Size Rearward Facing toddler CRS

- ISO/R2: Reduced-Size Rearward Facing toddler CRS
- ISO/R2X: Reduced-Size Rearward Facing toddler CRS
- ISO/R1: Rearward Facing infant CRS
- ISO/L1: Left Lateral Facing position CRS (carry-cot)
- ISO/L2: Right Lateral Facing position CRS (carry-cot)

Notes on installing a child restraint system

⚠ WARNING Risk of injury due to second row seat cushion and seat backrest not being engaged correctly

If the second row seat cushion and backrest are not engaged correctly, they may fold forward, for example, when suddenly braking or encountering an accident.

- In this case, the vehicle occupant will be pushed into the seat belt by the second row seat cushion or backrest. Seat belts will not provide the best level of protection and may cause additional injuries.
- If the seat backrest is folded forward, the objects or loads in the boot could slip forward.
- ▶ Always make sure the second row seat cushion and backrest are engaged correctly before each journey.

When fitting a child restraint system, observe particularly the following:

- Always observe the correct use of the seats and consider their suitability for attaching a child restraint system.
- Always observe the child restraint system manufacturer's installation instructions.
- Make sure the child's feet do not touch the front seat. If necessary, move the front seat forward slightly.

When fitting an ISOFIX/i-Size child restraint system, also observe the following:

- When using a backward-facing child restraint system on a second row seat, adjust the front seat to prevent it from touching the child restraint system.
- If necessary, remove the head restraint from the corresponding seat when a forward-facing child restraint system interferes with the head restraint. In addition, the backrest of the child restraint system must be as close as possible to the backrest of the vehicle seat.

After removing the child restraint system, install the head restraint immediately and adjust it correctly. Do not remove the head restraint when using a child booster cushion.

- The child restraint system must not touch the roof and/or be fitted facing the wrong direction.
- The child restraint system must not be put under strain by the head restraint. If necessary, adjust the head restraint accordingly.

Fitting an ISOFIX or an i-Size child restraint system

⚠ WARNING Risk of injury or death if the weight of the child exceeds the permissible gross mass

For ISOFIX/i-Size child restraint systems in which the child is secured using the seat belt integrated in the child restraint system, the weight of the child shall not exceed the permissible gross mass of the child restraint system.

If the child weighs more than the permissible gross mass, the ISOFIX/i-Size child restraint system with integrated seat belt does not offer sufficient protection. For example, too much load may be placed on the ISOFIX/i-Size child seat and the child may not be restrained correctly in the event of an accident.

- ▶ If the child weighs more than the permissible gross mass, the ISOFIX/i-Size child restraint system and the vehicle seat belt must be used together.
- ▶ Also secure the child restraint system with the TOP TETHER belt, if available.

Always observe the following child restraint system instructions regarding the weight:

- In the manufacturer's installation and operating instructions for the child restraint system used.
- On the label of the child restraint system, if present.

Regularly check the weight of the child and make sure it is still complied with the permissible gross weight of the child restraint system.



Before every trip, make sure that the ISO-FIX/i-Size child restraint system is engaged correctly in both anchor points on the seat.

! **NOTE** When installing a child restraint system, be careful not to damage the seat belt.

► Make sure the seat belt is not caught.

Attach the ISO-FIX/i-Size child restraint system to both anchor points on the seat.

Attaching TOP TETHER to the front passenger seat



ISO-FIX/i-Size label is located on the front passenger seat's rear curtain.

Fitting child seat securing system



1. Adjust the seat ① backward if necessary.
2. Fitting the ISO-FIX/i-Size child restraint system with TOP TETHER. Observe the child restraint system manufacturer's installation instructions when doing so.
3. Pass the TOP TETHER belt through the space under the head restraint.
4. Release the seat rear curtain lace ②, fold the rear curtain upward to gain access to the anchorage.
5. Attach the hook of the TOP TETHER belt to the anchorage ③. Be careful not to twist it.
6. Tension the TOP TETHER belt. Observe the child restraint system manufacturer's installation instructions when doing so.

Attaching TOP TETHER to the second row seat

! **WARNING** Risk of injury or death if the second row seat backrest is not locked after the TOP TETHER belt is installed

If the second row seat backrests are not locked, they may fold forward in case of an accident, emergency brake or sudden steering, resulting in the failure of the child restraint system to provide the intended protection. The unlocked second row seat backrests may also cause other injuries in an accident.

► After installing the TOP TETHER belt, lock the second row seat backrests.

The risk of injury can be reduced by TOP TETHER. The TOP TETHER belt allows an additional connection between the child restraint system attached with ISOFIX/i-Size and the vehicle.

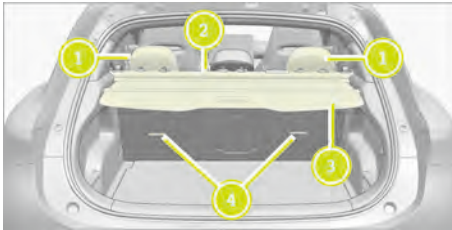

1. If necessary, remove or slide the head restraint **1** upward.
2. Fitting the ISOFIX/i-Size child restraint system with TOP TETHER. Observe the child restraint system manufacturer's installation instructions when doing so.
3. Guide the TOP TETHER belt **5** through the space between the two head restraint bars under the head restraint **1**.
4. Pass the TOP TETHER belt **5** between the boot cover **2** and the seat back **3**.
5. Attach the hook **6** of the TOP TETHER belt to the anchorage **4**. Be careful not to twist it.
6. Tension the TOP TETHER belt **5**. Observe the child restraint system manufacturer's installation instructions when doing so.
7. If necessary, slide the head restraint **1** downward. Make sure that the correct arrangement of the TOP TETHER belt **5** is not affected.

Installing seat belt-secured child restraint systems

Always observe the installation instructions provided by the child restraint system manufacturer. Observe the following general guidelines for seat belt-secured child restraint systems:

- Make sure that the child restraint system is suitable for the child's weight, height and age.
 - Avoid dressing the child with bulky clothes.
 - Never place objects between the child and the child restraint system.
 - Adjust the seat belt of the child restraint system for each child accordingly before every journey.
1. Place the child restraint system on a suitable seat and pull out the seat belt completely. Tighten and fasten the seat belt according to the installation instructions provided by the child restraint system manufacturer.
 2. Guide the vehicle seat belt through the child restraint system and engage the seat belt tongue into the buckle. Make sure the seat belt is not twisted. Fasten the vehicle seat belt firmly to the child restraint system according to the installation instructions of the child restraint system.
 3. If the child restraint system is not equipped with a vehicle seat belt locking device, purchase a locking clip to lock the vehicle seat belt in place.
 4. Shake the child restraint system back and forth to make sure the child restraint system is firmly installed.

Install a child restraint system on the second row middle seat

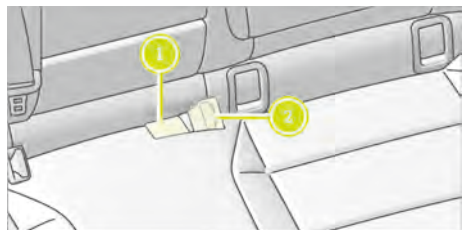

- ❶ No. 5 buckle
- ❷ No. 4 buckle

When installing a child restraint system, if the No. 5 buckle ❶ interferes, move the No. 4 buckle ❷ forward and hide it in the seat cushion to make room for the No. 5 buckle ❶ to tilt sideways, thus minimize the interference.

Notes on installing a child restraint system on the front passenger seat

Notes on the rearward-facing and forward-facing child restraint systems on the front passenger seat

⚠ WARNING Risk of injury or death if a rearward-facing child restraint system is used while the passenger airbag is enabled

If you secure a child in a rearward-facing child restraint system on the front passenger seat and the passenger airbag is enabled, the passenger airbag can deploy in the event of an accident and impact the child.

- ▶ Make sure the passenger airbag is disabled. The passenger airbag off indicator must be on.
- ▶ Never use a rearward-facing child restraint system on a seat protected by an active airbag in front of it; death or serious injury to the child can occur.

Always pay attention to the status of the passenger airbag using the PASSENGER AIR BAG OFF indicator

- If a child restraint system is installed on the front passenger seat, observe the notes on disabling the passenger airbag.
- When using a rearward-facing child restraint system on the front passenger seat, the passenger airbag must always be disabled.
- If the PASSENGER AIR BAG ON indicator is turned on, the front passenger airbag is enabled. The front passenger airbag may deploy during an accident.

- When installing a child restraint system on the front passenger seat, adjust the front passenger seat as far back as possible and move the seat into the highest position.

Child lock

⚠ WARNING Risk of accident and injury due to children left unattended in the vehicle

If children are left unattended in the vehicle, they could in particular:

- Open doors, thereby endangering other persons or road users.
- Get out and be struck by oncoming traffic.
- Operate vehicle equipment and become trapped.

In addition, children could also set the vehicle in motion, by in particular:

- Releasing the parking brake
- Shifting the gear
- Starting the vehicle
- ▶ Never leave children unattended in the vehicle.
- ▶ When leaving the vehicle, always take the key with you and lock the vehicle.
- ▶ Keep the key out of the reach of children.

A child lock can prevent the rear door from being opened from the inside and the rear window lifter from being operated.

Enabling/disabling the child lock

Enter the vehicle setting interface, tap *Quick Controls > Child Lock > Left child lock/ Right child lock* to enable/disable child lock.

Traveling safely with pets in the vehicle

Notes on pets in the vehicle

If pets are traveling in the vehicle, observe the notes on traveling with pets.

⚠ WARNING Risk of accident and injury due to animals left unsecured or unattended in the vehicle

If you leave animals in the vehicle unattended or unsecured, they could possibly press down buttons or switches.

Thereby an animal may:

- Activate vehicle equipment and become trapped

- Switch systems on or off and endanger other road users.
- ▶ Never leave animals in the vehicle unattended.
- ▶ Always correctly secure animals while driving, for example using a suitable animal carrier.

Key

Overview of the key functions

⚠ WARNING Risk of accident and injury due to children left unattended in the vehicle

If children are left unattended in the vehicle, they could in particular:

- Open doors, thereby endangering other persons or road users.
- Get out and be struck by oncoming traffic.
- Operate vehicle equipment and become trapped.

In addition, children could also set the vehicle in motion, by in particular:

- Releasing the parking brake
- Shifting the gear
- Starting the vehicle
- ▶ Never leave children unattended in the vehicle.
- ▶ When leaving the vehicle, always take the key with you and lock the vehicle.
- ▶ Keep the key out of the reach of children.

Keyfob

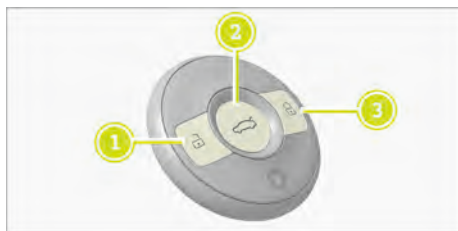

- 1 Unlock and the turning signal lights flash.
- 2 Press briefly to unlock/lock the liftgate; press and hold to open/close the liftgate.
- 3 Lock and the turning signal lights flash.

- ① When the keyfob battery is low, a message pops up on the centre display. Replace the battery as soon as possible.

The keyfob can lock and unlock the following components:

- Doors
- Charging port cover
- Liftgate

Do not stow the keyfob with electronic equipment or metal objects. The performance of the keyfob may be affected.

⚠ NOTE Strong magnetic field damages the keyfob.

- ▶ Keep the keyfob away from strong magnetic fields.

smart APP Bluetooth key (if equipped).

You can register for smart APP Bluetooth key through the smart APP and then unlock/lock the vehicle with the mobile phone.

When you approach the vehicle with your mobile phone, the vehicle detects the Bluetooth signal of the mobile phone. You can now unlock/lock the vehicle with the smart APP Bluetooth key.

Pay attention to the following when using the smart APP Bluetooth key:

- Turn on the smart APP and enable Bluetooth.
- The performance of Bluetooth connection depends on the intensity of Bluetooth signal of the mobile phone used, and is easily affected by environmental factors such as strong magnetic field and object occlusion.
- The smart APP Bluetooth key has an anti-play mechanism. When locking and unlocking the vehicle using the smart APP Bluetooth key, the time gap between the unlock and lock operations normally needs to be longer than 20 seconds. If the time gap between the 2 operations is shorter than 20 seconds, the operation may fail.

Key sharing

The owner can share the vehicle key with others through the smart APP.

Vehicle re-lock

If no door has been opened after the vehicle being unlocked for a period of time, the vehicle automatically locks up. The anti-theft alarm system is activated again.

Find My Car

When you forget where the vehicle is parked, press  on the keyfob briefly twice to use Find My Car, so the vehicle lights flash and the horn sounds.

Set the Find My Car prompt option

Enter the setting interface:

- Tap  > *Vehicle Settings* > *Vehicle Control* > *Find My Car*, and select Flash + Horn/Flash.

Enabling/Disabling Lock Sound

When the lock sound is enabled, the vehicle horns during locking to confirm vehicle is locked.

Turning on/off Lock Sound

Enter the setting interface:

- Tap  > *Vehicle Settings* > *Vehicle Control* > *Lock Sound* to turn on/off Lock Sound.

Enabling/disabling Double Click Unlock

When two-step unlocking is enabled, press the unlock button on the remote key to unlock the driver's door, and press it again to unlock all doors.

Turning on/off two-step unlocking

Enter the setting interface:

- Tap  > *Vehicle Settings* > *Vehicle Control* > *Two-step Unlocking* to turn on/off the Two-step Unlocking function.

Removing and installing the mechanical key

Removing the mechanical key



1. Turn the keyfob lower cover in the direction of the arrow **1** and remove it.

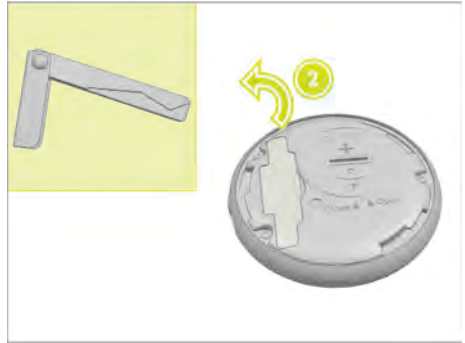

2. Open the mechanical key cover in the direction of the arrow **2** and take out the mechanical key.

Installing the mechanical key

Return the mechanical key to the original location, and then install the mechanical key cover and the keyfob lower cover.

Replacing the keyfob battery

⚠ WARNING Serious damage to health caused by swallowing batteries

Batteries contain toxic and corrosive substances. Swallowing batteries may cause serious damage to health and risk of fatal injury.

- ▶ Keep batteries out of the reach of children.
- ▶ If batteries are swallowed, seek medical attention immediately.

ENVIRONMENTAL NOTE Environmental damage from improper disposal of batteries



Batteries contain pollutants. Do not discard batteries with the household rubbish.



▶ Dispose of batteries in an environmentally responsible manner. Take discharged batteries to a smart Authorized Service Partner or a used battery recycling point.

Requirements for battery:

- A 3-volt CR 2032/2032H button cell is required.

Replacing the keyfob battery:



1. Turn the keyfob lower cover in the direction of the arrow **1** and remove it.



2. Insert a suitable tool into the groove of the battery compartment cover and turn in the direction of the arrow **2** to the Open position, then remove the cover **3**.



3. Remove the keyfob battery **5**.
4. Install a new battery into the battery compartment, install the battery compartment cover, insert a suitable tool into the groove of the battery compartment cover and turn in the direction of the arrow **4** to the Close position. Install the keyfob lower cover.

Problems with the keys

If the vehicle cannot be locked/unlocked

Possible causes:

- The keyfob battery is low or exhausted.
- The keyfob is malfunctioning.
- When the keyfob tightly adheres to electronic equipment such as mobile phone and computer, it may fail. When the keyfob leaves the interference source, its function can be recovered.
- There is a strong radio interference source.
 - The vehicle is near a radio tower/TV tower or power station.
 - There are radio devices around the vehicle, such as transmitters or radio broadcasting devices
- Operating the keyfob invalidly.
 - The function will be disabled after 10 consecutive operations of the keyfob to lock or unlock the vehicle within 60 seconds, and then will automatically recover after 120 seconds.

In case of losing your keyfob or mechanical key

- Contact a smart Authorized Service Partner.

In case of losing your mobile phone with registered Bluetooth key

Once your phone is lost, immediately log in to the smart App with another mobile phone and delete the lost Bluetooth key. If deletion fails many times, contact a smart Authorized Service Partner immediately.

Doors

Unlocking/opening the doors from inside

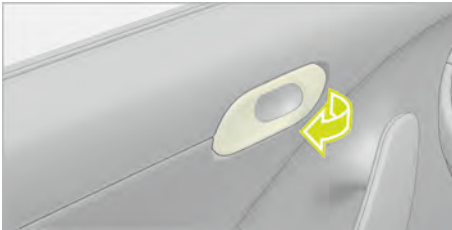

When the vehicle is unlocked:

Pull the door handle to open the door.

When the vehicle is locked:

Pull the door handle to unlock the door, and pull the door handle again to open the door.

Unlocking/locking the vehicle from the central lock



1. **Unlock:** press the button .

2. **Lock:** press the button .

If the vehicle is locked as below, the above operation cannot unlock the vehicle:

- Using the keyfob or the smart APP Bluetooth key (if equipped).
- Using keyless entry.

Unlocking/locking the vehicle with Keyless Entry

Enabling conditions



- The key is outside the vehicle
- The distance between the key and the vehicle is within 1.5 meters at the 2 front doors or 1 meter at the liftgate.

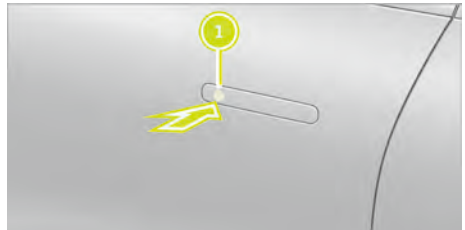

To unlock:

Bring along the key and touch the sensing area **1** on the front door handle. When the door handles pop out, the vehicle is unlocked.

To lock:

When the vehicle doors and liftgate are all closed, bring along the key and touch the sensing area **1** on the door handle. When the door handles retract, the vehicle is locked.

Touch to unlock setting

Enter the setting interface:

- Tap  > *Vehicle settings* > *Vehicle control* > *Touch to unlock* to set touch unlocking of left or right doors or all doors.

Approach to Unlock/Walk Away to Lock

When the function is enabled, the vehicle automatically unlocks or locks when it detects the key entering or leaving the sensing area.

Approach to Unlock

When the vehicle is locked, bring the key within about 1.5 meters of the vehicle, the door handles will pop out, and the vehicle will be automatically unlocked.

- ① The remote control key is easily interfered with by electronic devices such as mobile phones and power banks, as well as external magnetic fields. In case of interference described above, the Approach to Unlock function will fail. At this time, you can unlock the door by touching the door handle or using the key.

Walk Away to Lock

When both the doors and the liftgate are closed and the key is about 2 meters away from the vehicle, the door handles retract and the vehicle will be locked automatically.

- ① The remote control key is easily interfered with by electronic devices such as mobile phones and power banks, as well as external magnetic fields; please confirm whether the vehicle is locked when you use the Walk Away to Lock function.
- ① The keyfob is easily affected by the surrounding environment of the vehicle. For example, when there is a substation or charging station around the vehicle, the field strength generated in the environment will interfere with the keyfob. Please confirm whether the vehicle is locked when you use the Walk Away to Lock function.

Enabling/disabling Approach to Unlock/Walk Away to Lock

Enter the setting interface:

- Tap  > *Vehicle Settings* > *Vehicle Control* > *Approach to Unlock/Walk Away to Lock* to turn on/off the Approach to Unlock/Walk Away to Lock function.

- ① Make sure that your vehicle is locked to prevent the vehicle from not being locked automatically after you leave the vehicle due to external strong magnetic field interference and other factors.

- ① Even though the Walk Away to Lock function is enabled, it is ultimately your responsibility to ensure the vehicle is locked.

Automatic lock on drive

After the vehicle is started and the speed reaches 7 km/h(5 mph), the vehicle is locked automatically.

Automatic unlock in case of emergency

When the vehicle suffers a collision above a certain extent, the vehicle doors unlock automatically to facilitate the escape of occupants and the rescue from emergency responders.

Automatic unlock when parked

After the function is enabled, when the vehicle is stopped and shifted to park **P**, the vehicle doors and liftgate are unlocked automatically.

Turning on/off the unlock the vehicle at P gear

Enter the setting interface:

- Tap  > *Vehicle settings* > *Vehicle control* > *Unlock the vehicle at P gear* to turn on/off vehicle auto unlock at P gear.

Unlocking/locking the doors with the mechanical key

Unlocking/locking the driver's door

1. Take out the mechanical key (→ [Page 45](#)).

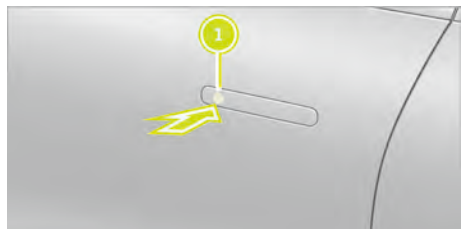

2. Press the frontal section ❶ of the door handle, pull the door handle.

- ❶ If the handle cannot be pulled, contact a smart Authorized Service Partner.

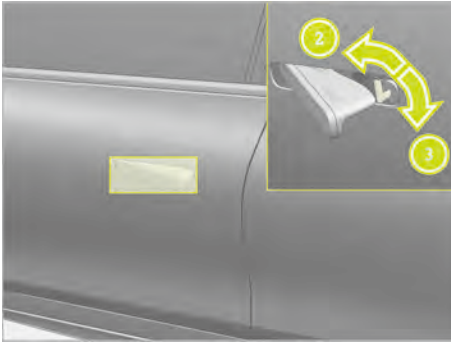

3. **Unlock the door:** insert the mechanical key into the key hole until it stops, rotate the mechanical key in the direction ❷, release the key, release the door handle, and pull the door handle again to open the vehicle door.

Lock the door: close the vehicle door, turn the mechanical key in the direction ❸, take out the key, and release the door handle.

Locking other doors

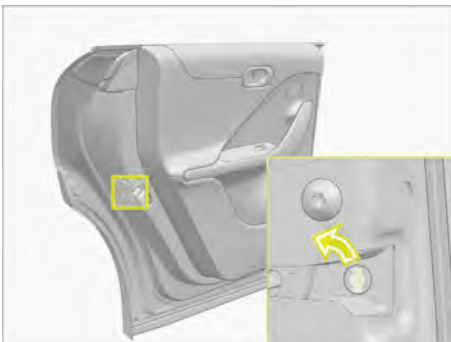

Turn the door lock in the direction of the arrow until it stops. The door will be locked once closed.

Double Lock (if equipped)

Overview of Double Lock

Once Double Lock is enabled, the door cannot be opened from inside.

Use of Double Lock

The door can be locked by the keyfob and Bluetooth key. After about 10 seconds, Double Lock will be enabled.

If a door is opened before Double Lock is activated, the activation of Double Lock will be interrupted and the alarm will be disabled.

During the activation/deactivation of Double Lock, the hazard warning lights flash.

Enabling/disabling Double Lock

The Double Lock is turned on by default, and can be temporarily turned off by settings.

Enter the setting interface:

- Tap > *Vehicle Setting* > *Vehicle Control* > *Temporarily Remove Alert*, and turn on *Temporarily Remove Alert* to temporarily turn off the Double Lock.

Liftgate

Opening the liftgate



- ❗ **NOTE** Damage of liftgate due to obstacles above the vehicle

The liftgate swings backward and upward when it is opened.

- Make sure that there is sufficient space behind and above the liftgate.

You can open the liftgate in the following ways:



- Press and hold the button  on the keyfob.
- Press and hold the button **1** on the combination switch of the driver side instrument panel.
- Tap the button  on the centre display.
- Press the button on the smart APP Bluetooth key (if equipped).
- Vehicles equipped with foot kick power liftgate: bring along the keyfob and kick below the rear bumper.



- Bring along the keyfob and press the button **2** on the liftgate.

Power liftgate: press the button **2** on the liftgate to unlock, the liftgate opens up automatically and gradually.

- i** The liftgate opening and closing processes stop if there are people or obstacles block its movement. Make sure the area is clear of people and obstacles when opening and closing the liftgate.

Closing the liftgate

⚠ WARNING Risk of injury from unsecured items in the vehicle



If objects are not secured or not secured sufficiently, they could slip, tip over or be flung around and thereby hit vehicle occupants.

There is a risk of injury, particularly in the event of sudden braking or a sudden change in direction.





- ▶ Always stow objects in such a way that they cannot be flung around.
- ▶ Before the journey, secure objects against slipping or tipping over.

⚠ WARNING Risk of being trapped during automatic closing of liftgate

During the automatic closing of the liftgate, body parts may be trapped. For example, children may be standing or entering the closing area.

- ▶ Make sure that no one is near the closing area during the closing process.
- ▶ Stop closing the liftgate in one of the following ways:
 - Press the button  on the keyfob.
 - Press the button  on the instrument panel combination switch on the driver side.
 - Press the button  on the liftgate.
 - Use the smart APP Bluetooth key (if equipped).
 - Vehicles equipped with foot kick power liftgate: kick below the rear bumper.

You can close the liftgate in the following ways:

- Vehicles equipped with foot kick power liftgate: bring along the keyfob and kick below the rear bumper.
- Press and hold the button  on the keyfob.
- Press and hold the button  on the combination switch of the driver side instrument panel.
- Vehicle with power liftgate: press the button  on the liftgate.
- Use the smart APP Bluetooth key (if equipped).
- Tap the button  on the centre display.

Foot kick power liftgate



When the vehicle detects the keyfob or smart APP Bluetooth key, you can open, close, or stop the liftgate by kicking below the rear bumper.

The kicking motion alternately triggers the opening and closing process.

Observe the notes on liftgate opening.

- ① A warning sound will be issued when the foot kick power liftgate is opened or closed.

When kicking, make sure you stand on the ground firmly, or you may lose balance or fall down.

Observe the following:

- If a kicking action is not recognized, please take back your foot from the sensing area and then kick again.
- In the sensing area, please do a quick and smooth kicking action.
- The keyfob or Bluetooth key is behind the liftgate.
- When kicking, stand at least 30 centimeters away from the vehicle.
- Do not touch the bumper when kicking.
- Do not move too slowly when kicking.
- The kick must point toward the sensor.

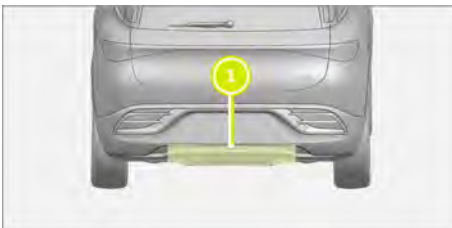

- ① Sensing area.

System limitation

The system may be affected or inoperative under the following circumstances:

- The area around the sensor is dirty due to snow melt, salt or snow.
- Kick with artificial limbs.

The liftgate may open or close accidentally under the following circumstances:

- Someone's arm or leg moves within the detection range of the sensor, such as polishing a vehicle or picking up an item.
- Someone moves or places objects behind the vehicle.
- Fastening tape, tarpaulin or other covering covers the bumper.
- A protective pad with a length exceeding the boot frame beam is used, which blocks the detection range of the sensor.
- The protective pad is not properly secured.

Setting the liftgate opening angle

Manually adjusting the liftgate opening angle

If necessary, you can set the liftgate opening angle.

1. Manually open the liftgate to the desired height.
2. Press the button  on the lower edge of the liftgate until an audible signal is heard.
3. The opening angle is set.



Restore the maximum opening angle:

1. Manually open the liftgate to the highest position.
2. Press the button  on the liftgate until an audible signal is heard.

Setting the liftgate opening angle on the centre display

You can adjust the opening of liftgate to the height that suits your needs.

Enter the setting interface:

- Tap  > *Quick Controls* >  and set the liftgate opening height (position 1, 2, 3, 4, 5).

Unlocking the liftgate mechanically

If the battery is low or the lock mechanism is broken, the liftgate can be opened from the inside mechanically. The operation steps are as follows:

1. Fold the second row seat backrest forward.



2. Press the clip and remove the trim panel 1.

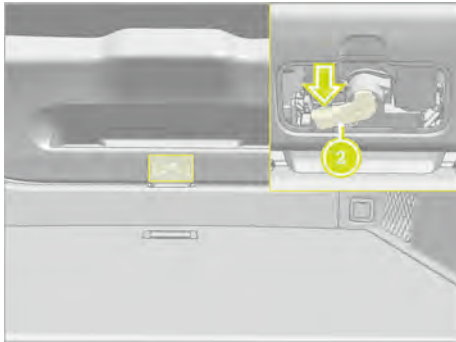

3. Press the unlock switch 2 and the liftgate unlocks.

Windows

Opening and closing the windows

⚠ WARNING Risk of being trapped when opening and closing a window

When opening and closing a window, parts of the body could be drawn in or be trapped between the window and window frame.

- ▶ When opening and closing windows, make sure that nobody is touching the window.
- ▶ If someone is trapped, release the window switch immediately.

⚠ WARNING Risk of being trapped when children operate the windows

Children could be trapped if they operate the windows, particularly when unattended.

- ▶ Enable the rear window child lock.
- ▶ When leaving the vehicle, always take the key with you and lock the vehicle.
- ▶ Never leave children unattended in the vehicle.



- 1 One touch up
Pull the button past the point of resistance and release, the window will be closed fully.
- 2 Closing
Pull the button.
- 3 Opening
Press the button.
- 4 One touch down

Press the button past the point of resistance and release, the window will be opened fully.

Windows can rise and lower slightly in the following conditions:

- When a door is being opened, the window lowers slightly to facilitate the operation.
- After lowering, the window rises back up once the door is closed to prevent leak.
- When a door is being opened as its window sitting at the very bottom, the window rises slightly to prevent shaking.

When the vehicle is powered off and the windows are fully closed, do not open doors unnecessarily.

Window anti-pinch

If an object blocks or restricts a window as it is closing, the window will open again automatically.

During the closing process, make sure that no objects or body parts are restricting the window closing operation.

⚠ WARNING Risk of becoming trapped despite the anti-pinch protection of the windows

The reversing function does not react:

- Soft, small objects or body parts.
- During self-learning of anti-pinch function.

The anti-pinch function cannot prevent people from becoming trapped in these situations.



- ▶ During closing of windows, make sure that there are no objects or body parts that hinder the closing action of windows.
- ▶ If someone is trapped, press the button  to open the window again.

Controlling the windows from the centre display



The switches on the driver's door have higher priority, and the window opening

position can also be adjusted on the centre display.



Close all windows

- Enter the shortcut interface:
Swipe downward on the centre display or tap  >  to close all windows.

Open all windows

- Enter the shortcut interface:
Swipe downward on the centre display or tap  >  to open all windows.

Ventilate

- Enter the shortcut interface:
Swipe downward on the centre display or tap  >  to open the window for ventilation.

Convenient opening

⚠ WARNING Risk of being trapped when opening and closing a window

When opening and closing a window, parts of the body could be drawn in or be trapped between the window and window frame.

- ▶ When opening and closing windows, make sure that nobody is touching the window.
- ▶ If someone is trapped, release the window switch immediately.

Press the button  on the keyfob, and the vehicle performs the following:

- Unlocking the vehicle
- Unfolding the outside rearview mirrors automatically (if the function is enabled)

Press and hold the unlock button on the central lock inside the vehicle, and the vehicle windows open.

Press and hold the button  on the keyfob, and the vehicle windows open.

Convenient closing

⚠ WARNING Risk of becoming trapped due to accidental operation of convenient closing function

When the convenient closing function is in operation, body parts could be trapped in the closing areas of the windows in the process.

- ▶ When closing, make sure that no body parts are in the closing area.

Press and hold the button  on the remote control key, or press and hold the sensing area of the exterior door handle carrying the remote control key, so the vehicle will perform the following functions:

- Locking the vehicle
- Closing the windows
- Automatic folding of outside rearview mirror (if the function is enabled)

Press the button  on the remote control key again midway to interrupt the above operation.

Press and hold the lock button of the central lock in the car to close the windows.

Problems with the windows

Possible causes of windows not being able to close:

1. Check whether there are objects in the window guides.
2. Adjust the windows.
 - If the windows are obstructed during closing or the one touch up function of the windows is malfunctioning, follow the following to perform window relearn:
 - Pull the switch upward and release the switch 3 seconds after the window has reached the top.
 - Press the switch to lower the window all the way down and release the switch.
 - Pull the switch up to raise the window all the way to the top and release the switch.

- After the relearn is complete, test whether there is a one touch up function.

- ① It is your responsibility to ensure that windows are closed after the vehicle is locked.

Anti-theft protection

Anti-theft system

The anti-theft system is an electronic system to protect valuables such as the vehicle and personal property.

The anti-theft system prevents others from illegally starting your vehicle. Only after receiving the key information matching the vehicle can the vehicle be started. If the anti-theft system is enabled, the vehicle status will be continuously monitored. An alarm will be triggered when the door/liftgate is not opened legally.

The vehicle is also equipped with a tracking system, which can track and locate the vehicle and remotely activate the anti-theft system to prevent the vehicle from being started. If the remote anti-theft system is activated, a message of vehicle failure in start will pop up on the driver information display.

If the driver information display indicates that the anti-theft system is faulty, contact a smart Authorized Service Partner for inspection as soon as possible.

When the vehicle is locked and the anti-theft system is enabled, an alarm will be triggered under the following conditions:

- The door or liftgate is opened without a valid key.
- Motion in the cabin is detected when the vehicle is equipped with interior motion sensors.
- The vehicle is lifted or towed when it is equipped with motion and tilt sensors.
- The 12V battery cable is disconnected.

NOTE

This vehicle features an anti-theft system, but it can not prevent all acts of theft and make sure the absolute safety of the vehicle.

- ⓘ If there is strong electromagnetic interference around the vehicle, such as power plant and signal tower, the anti-theft system may not work normally.

Enabling/disabling the anti-theft protection

When the vehicle is locked, the anti-theft system is enabled automatically. After unlocking the vehicle, the anti-theft system is automatically disabled.

- If a door is not closed, the vehicle cannot be locked and the anti-theft system cannot be switched on.
- If the liftgate or bonnet is opened, the anti-theft system will be partially enabled. After the liftgate or bonnet is closed, the anti-theft system is fully enabled.

Disabling the triggered anti-theft alarm

When the alarm is triggered, the following happens:

- The alarm sounds for 30 seconds or until it is switched off.
- The hazard warning lamps flash for 5 minutes or until it is switched off.

If the cause of alarm triggering is not solved, the alarm cycle repeats up to 10 times.

Switching off the alarm

You can turn off the triggered alarm system in any of the following ways:

- Unlock the vehicle with a keyfob or the smart APP Bluetooth key (if equipped).
- Start the vehicle.

- ⓘ Using the smart APP to control the vehicle remotely (remote unlock excluded) cannot turn off the triggered anti-theft system.

Steering wheel lock (if equipped)

The steering wheel lock can make it difficult to maneuver the vehicle in the event of a theft, etc.

- ⓘ Mechanical noise may be heard when the steering wheel is being locked or unlocked.

Enabling the steering wheel lock

When the vehicle is locked from outside, the steering wheel lock is enabled.

Disabling the steering wheel lock

When the vehicle is unlocked from the outside or when the vehicle is not in **P** gear, the steering wheel lock is disabled.

Motion and tilting alarm (if equipped)

When the alarm is enabled, motion and tilting sensors detect vehicle movement or changes in the vehicle's angle to the ground. Significant changes in vehicle angle or vehicle movement can activate the alarm.

Vehicle intrusion alarm (if equipped)

When the vehicle intrusion alarm is enabled, the interior motion sensors detect movement inside the vehicle, including the airflow through the open windows.

When the alarm is fully enabled and the alarm sensors are active, any significant movement in the passenger compartment can trigger the alarm.

To avoid accidental triggering of the alarm:

- Close all windows when leaving the vehicle.
- If using the climate control, adjust the airflow direction so that it does not blow upward in the passenger compartment.

Seats

Notes on the correct driver's seat position

- ⚠ WARNING** Risk of injury if vehicle settings are adjusted while the vehicle is in motion

You could lose control of the vehicle particularly in the following situations:

- If you adjust the driver's seat, steering wheel, or mirrors while the vehicle is in motion.
- If you fasten your seat belt while the vehicle is in motion.
- ▶ Before starting the vehicle, adjust the driver seat, steering wheel and mirrors and wear the seat belt correctly.

When adjusting the driver's seat, the steering wheel and the seat belt, observe the following:

- You are as far away from the driver's airbag as possible.
- Sit in an almost upright position with the back against the seat backrest.
- Sit with the legs slightly supported on the seat cushion.
- Your legs are not fully extended and you can press the pedals properly.
- You can reach the steering wheel with your arms slightly bent.
- You can move your legs freely.
- All displays on the driver information display and the head-up display (if equipped) can be clearly seen.
- You can be fully aware of traffic conditions.
- When adjusting the seat position, do not touch any moving parts to avoid injury and/or damage.
- Your seat belt is pulled snugly against your body and is routed across the centre of your shoulder and across your hips in the pelvic area.

Electrically adjusting the front seats

- ⚠ WARNING** Risk of injury if vehicle settings are adjusted while the vehicle is in motion

You could lose control of the vehicle particularly in the following situations:

- If you adjust the driver's seat, steering wheel, or mirrors while the vehicle is in motion.
- If you fasten your seat belt while the vehicle is in motion.
- ▶ Before starting the vehicle, adjust the driver seat, steering wheel and mirrors and wear the seat belt correctly.

- ⚠ WARNING** Risk of injury due to adjusting the seats incorrectly

- ▶ Make sure that the front seats are locked in place before driving. Otherwise, personal injury could occur in case of an accident or emergency braking.
- ▶ Never adjust the seat when the vehicle is in motion. Otherwise, the vehicle may lose control.
- ▶ Adjust the seat correctly and make sure the brake pedal can be pressed down all the way. As long as this condition is met, adjust the seat as far back as possible to make sure the seating is comfortable and the vehicle is easy to operate.

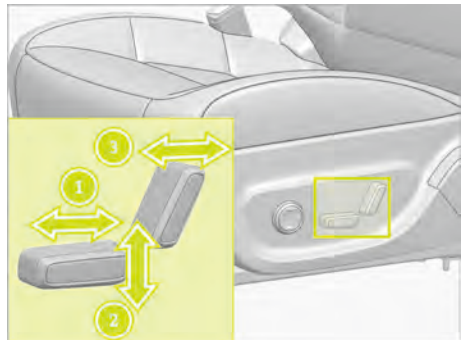

1 Adjusting the seat forward/backward:

Toggle the control button forward or backward.

2 Adjusting the seat cushion height: Toggle the control button upward or downward.**3 Adjusting the seat backrest angle:** Toggle the control button forward or backward.

- i** When the vehicle is not in the **READY** state, do not operate the power seat for a long time to prevent the 12 V battery from running out.

Adjust the seat height to the lowest position when you need to adjust the front seat backrest to the upright position and the front position. Verify the distance between the seat head restraint and the sun visor/headliner during fore-aft adjustment to avoid crushing damage.

Adjusting the 4-way lumbar support

- ⚠ WARNING** Risk of injury if vehicle settings are adjusted while the vehicle is in motion

You could lose control of the vehicle particularly in the following situations:

- If you adjust the driver's seat, steering wheel, or mirrors while the vehicle is in motion.
- If you fasten your seat belt while the vehicle is in motion.
- ▶ Before starting the vehicle, adjust the driver seat, steering wheel and mirrors and wear the seat belt correctly.

- ⚠ WARNING** Risk of injury due to adjusting the seats incorrectly

- ▶ Make sure that the front seats are locked in place before driving. Otherwise, personal injury could occur in case of an accident or emergency braking.
- ▶ Never adjust the seat when the vehicle is in motion. Otherwise, the vehicle may lose control.
- ▶ Adjust the seat correctly and make sure the brake pedal can be pressed down all the way. As long as this condition is met, adjust the seat as far back as possible to make sure the seating is comfortable and the vehicle is easy to operate.



- 1** Rising
- 2** Forward
- 3** Lowering
- 4** Backward

Use the buttons **1** to **4** to adjust the lumbar support.

Folding/unfolding the second row seat backrests**Folding the seat backrests**

Pull the tab **1** to fold the seat backrest.

Unfolding the seat backrests

Push the seat backrest backward to the stop position. After the adjustment, make sure the backrest is firmly engaged.

- ① Pull the pull ring as shown in the figure above. Improper operation may cause damage to the seat cover.

Head restraint

⚠ WARNING Risk of injury due to improperly installed or adjusted head restraint

If the head restraint is not properly installed or adjusted, it will not provide the best level of protection.

This increases the risk of head and neck injuries, such as in an accident.

- ▶ When adjusting the head restraint, make sure the top of the head restraint is flush with the top of your head.

Never exchange the head restraints of the second row seats. Otherwise, the height of the head restraints can not be adjusted correctly.

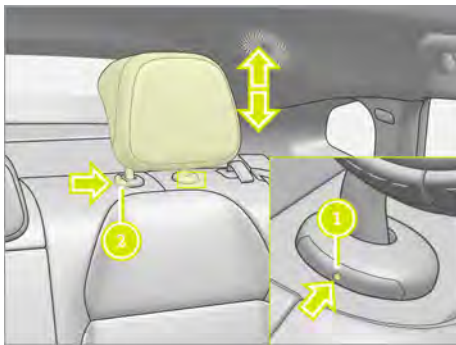

1. **Adjusting the height of head restraint:**
Pull up directly to raise the head restraint; press the button ② and push down to lower the head restraint.
2. **Removing/installing the head restraint:**
Fold the second row seat backrest (→ Page 57), press the button ② and at the same time insert a suitable tool into the hole ① and push upward to remove the head restraint; Insert the bars into the

guide sleeves and push down the head restraint until it engages.

Setting Easy Entry/Exit

⚠ WARNING Risk of injury caused by Easy Entry/Exit

Easy Entry/Exit may cause harm to passengers in the second row seats

- If there are passengers behind the driver's seat, the backward movement of the driver's seat may cause injury after Easy Entry/Exit is activated.

When Easy Entry/Exit is enabled, the driver's seat is automatically adjusted to facilitate entering and exiting the vehicle.

Enter the setting interface:

- Tap > *Vehicle Settings* > *Vehicle Control* > *Easy Entry/Exit* to turn on/off Easy Entry/Exit.

After the vehicle is stopped completely and shifted to park **P**, open the driver's door and the seat will be adjust to an appropriate position to facilitate exiting the vehicle.

When you are seated in the vehicle and close the driver's door, the seat will automatically return to the position when you were driving last time.

- ① After Easy Entry/Exit is enabled, if the driver manually adjusts the seat position when getting in or off the vehicle this time, Easy Entry/Exit will no longer be triggered.

Steering wheel

Manually adjusting the steering wheel

- ⚠ WARNING** Risk of injury if vehicle settings are adjusted while the vehicle is in motion

You could lose control of the vehicle particularly in the following situations:

- If you adjust the driver's seat, steering wheel, or mirrors while the vehicle is in motion.
- If you fasten your seat belt while the vehicle is in motion.
- ▶ Before starting the vehicle, adjust the driver seat, steering wheel and mirrors and wear the seat belt correctly.

- ⚠ WARNING** Risk of entrapment for children when adjusting the steering wheel

Children could injure themselves if they adjust the steering wheel.

- ▶ Never leave children unattended in the vehicle.
- ▶ When leaving the vehicle, always take the key with you and lock the vehicle.



1. Fold down the lever **1** to unlock the steering column.
2. **Set the steering wheel height:** upward/downward adjustment **2**.

3. **Set the steering wheel distance:** forward/backward adjustment **3**.
4. Fold up the lever **1** to lock the steering column.
5. Move the steering wheel to make sure that the steering column is locked.

Memory function

Notes on memory function

- ⚠ WARNING** Accident risk due to using memory function while the vehicle is in motion

If the driver's seat memory function is used while the vehicle is in motion, the adjustment may cause you to lose control of the vehicle.

- ▶ Use the memory function only when the vehicle is stationary.

- ⚠ WARNING** Risk of becoming trapped when using memory function to set the seat

When the memory function adjusts the seat, you and other vehicle occupants (especially children) may be trapped.

- ▶ When using the memory function to adjust the seat, make sure that body parts are not within the moving range of the seat; if someone is caught, adjust the seat manually immediately to interrupt the seat memory setting.

- ⚠ WARNING** Risk of becoming trapped when children use memory function

If children enable memory function, they may be trapped, especially when unattended.

- ▶ Never leave children unattended in the vehicle.
- ▶ When leaving the vehicle, always take the key with you and lock the vehicle.

Seat memory function

⚠ WARNING Risk of injury if vehicle settings are adjusted while the vehicle is in motion

You could lose control of the vehicle particularly in the following situations:

- If you adjust the driver's seat, steering wheel, or mirrors while the vehicle is in motion.
- If you fasten your seat belt while the vehicle is in motion.
- ▶ Before starting the vehicle, adjust the driver seat, steering wheel and mirrors and wear the seat belt correctly.

⚠ WARNING Risk of being trapped despite the anti-pinch protection of the seat

The anti-pinch function does not react particularly:

- Soft, small objects or body parts.
- During self-learning of anti-pinch function.

The anti-pinch function cannot prevent people from becoming trapped in these situations.

- ▶ Before door closing, make sure that there are no objects or body parts hindering the movement of the seat.
- ▶ If someone is caught, manually adjust the side switch on the seat immediately to move away the seat.

During switching to a preference position or entering/exiting the rest mode, the driver's seat will automatically move, and if there are objects hindering the movement, the seat will stop moving. During movement, make sure that there are no objects or body parts hindering the movement of the seat.

Setting the memorized seat position

- ① The memorized position will change as personal accounts being switched.

A vehicle owner's account can save 3 memorized positions: Preference 1, Preference 2, and Preference 3. The names can be edited according to need, and when the vehicle is not registered with an account, only 2 preference positions are available.

To save: After adjusting the seat to the appropriate position, a box will pop out on the centre display. Tap Save or Save As to save the position to Preference 1, Preference 2, or Preference 3. Once saved, tap Preference 1, Preference 2, or Preference 3 on the centre display to adjust the seat to the memorized position.

Recover: The recover button can bring the seat back to its current preference position. For example, when the seat is adjusted in the Preference 1 position, tap the recover button and the seat will return to the memorized Preference 1 position.

Interrupt: Tapping Preference 1, Preference 2, and Preference 3 on the centre display or manually adjusting the seat during the position adjustment will interrupt the adjusting motion.

Stowage space

Notes on loading the vehicle

⚠ WARNING Risk of injury from unsecured items in the vehicle

There is a risk of objects slipping or being flung around and hitting vehicle occupants in the event of emergency braking or a sudden change of direction if they are not secured inside the vehicle sufficiently.

- ▶ Always stow objects in such a way that they cannot be flung around.
- ▶ Before the journey, secure objects against slipping or tipping over.

⚠ WARNING Risk of injury due to objects being stowed inappropriately

There is a risk of objects slipping or being flung around and hitting vehicle occupants in the event of emergency braking or a sudden change of direction if they are not stowed inside the vehicle appropriately. For examples, cup holders, open stowage spaces and mobile phone brackets cannot retain all the objects they contain in the event of an accident.

- ▶ Always stow objects in such a way that they cannot be flung around in these or similar situations.
- ▶ Always make sure that objects do not protrude from stowage spaces, luggage nets or stowage nets.
- ▶ Close all lockable stowage spaces before starting a journey.
- ▶ Always stow and secure heavy, hard, sharp-edged or fragile objects or objects that are too large in the boot.

The handling performance of a laden vehicle depends on the distribution of the load within the vehicle. Observe the following guidelines when loading and transporting:

- Do not surpass the gross vehicle weight rating and front/rear axle load.
- The load must not protrude above the upper edge of the seat backrest.
- When stowing objects in the boot, make sure that a boot cover is installed.
- Secure the objects and distribute the load evenly with boot luggage retaining buckles.

Interior stowage spaces

Overview of front stowage space

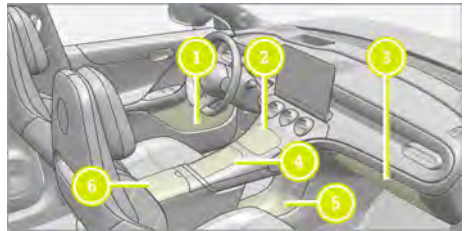

- 1 Door storage area.
- 2 Front storage box of centre console with charging port.
- 3 Glove box.
- 4 Centre console cup holders.
- 5 Stowage area below the centre console.
- 6 Centre console armrest stowage area.

Opening the glasses box in the centre of the headliner



Press **1** in the direction of the arrow to open the glasses box in the centre of the headliner.

Expanding the second row seat armrest



Pull the rope loop **1** outward to expand the second row seat armrest.

Opening or closing the boot floor cover

⚠ WARNING Risk of injury due to opening the boot floor cover.

If you drive with the boot floor cover open, objects may be flung around and hit the passengers. There is a risk of injury, particularly in the event of sudden braking or a sudden change in direction.

- Close the boot floor cover before each journey.



1. To **open**: pull the handle **1** upward and lift the boot floor cover upward.
2. To **close**: put the boot floor cover back in place.

Boot curtain

⚠ WARNING Risk of injury or death due to objects being poorly secured

The boot curtain alone cannot secure any heavy objects, items of luggage or heavy loads.

In the event of abrupt changes in direction, braking or an accident, you may be struck by unsecured loads.

- Always stow objects in such a way that they cannot be flung around.

! NOTE Damage to the boot curtain during vehicle loading

During loading of the vehicle, the boot curtain may be damaged.

- Never put anything on the boot curtain.

Installing and removing the boot curtain

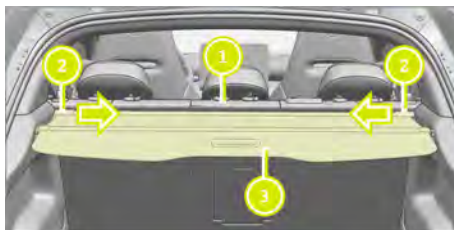

Removal: fold the second row seat backs **1** (→ Page 57), press the boot curtain shaft sleeve **2** toward the centre, and remove the boot curtain **3** forward from the groove.

Installation: fold the second row seat backs **1** (→ Page 57), press the boot curtain shaft sleeve **2** toward the centre, and put the boot curtain **3** into the groove backward from front.

Overview of the boot hooks

⚠ WARNING Risk of injury caused by hanging heavy objects on hooks

Hooks cannot fix heavy objects. During braking or emergency steering, objects may be flung around and hit the passengers.

- Never hang hard, sharp-edged or fragile objects on the hooks.

Observe the notes on loading the vehicle.

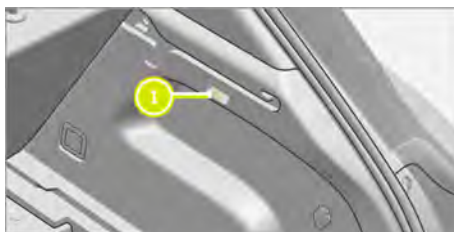

1 Hook

The hooks can hold loads up to 2.5 kilograms, and do not use them to secure cargo.

Luggage retention buckle for boot

When loading cargo in the boot, be sure to store the cargo properly and use the boot luggage retention buckles to secure them. Observe the notes on loading the vehicle.

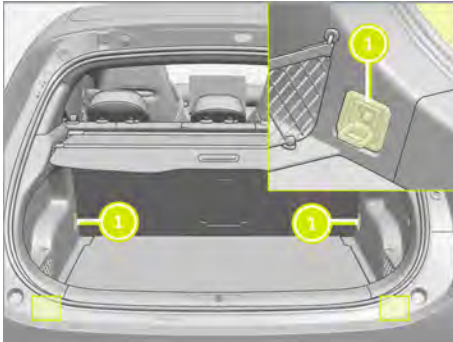

1 Luggage retention buckle

Notes on the roof luggage racks

⚠ WARNING Risk of injury due to exceeding the maximum roof load

After loading on the roof rails, the centre of gravity of the vehicle rises, and the driving characteristics, steering and braking characteristics of the vehicle are affected. When cornering, the vehicle tilts more seriously and may react more slowly to steering.

If the maximum roof load is exceeded, the driving characteristics, steering and braking characteristics of the vehicle will be seriously affected.

► Observe the maximum roof load and adjust your driving style.

! **NOTE** Luggage racks not approved by smart may cause damage to the vehicle

- Only luggage racks approved by smart can be used.
- After installing the luggage rack, ensure that the liftgate can be fully opened.
- When loading the roof luggage rack, ensure that the vehicle will not be damaged during driving.

Sockets

Using the 12 V power supply

The 12 V power supply port/outlet is located in the centre console and the boot of the vehicle.

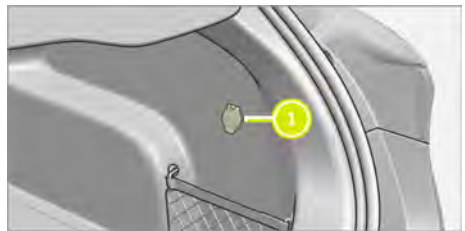

Lift up the cover 1 and insert the device connector.

Using the 12 V power supply

Requirements:

- The 12 V power supply can power electronic equipment, such as the electric air pump in the tyre repair kit.
- Do not use electrical equipment with ratings more than 12 V or 120 W.
- Never insert fingers or foreign objects, such as pens, into the power supply.

- Never touch the power supply with wet hands, or you may get electric shock.
- When not in use, cover the power supply.
- Never touch the socket with water or any other liquid.

USB

USB port

! NOTE

The output voltage is 5 V (up to 9 V under fast charge), and the maximum output current is about 3 A.

The USB ports are in the storage area below the centre display.

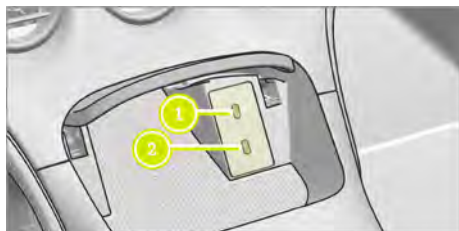

- 1 It is a special port for charging, which can provide up to 18 W fast charge (for mobile phones and tablets).
- 2 Connect with infotainment system for data transmission and mobile phone mapping.



- 1 Only used for charging mobile devices, such as mobile phones and tablets.

Mobile phone wireless charging

Notes on wireless charging

! NOTE Damage due to wireless charging

- ▶ Make sure that metal objects are far away from the charging board. Metal objects may overheat the charging board, and even cause accidents.
- ▶ Make sure that credit cards or other magnetic objects are far away from the charging board to avoid magnetic information being erased.

Pay attention to the following when charging wirelessly:

- The wireless charging function only supports mobile phones, headphones, stereos and other devices that meet the wireless charging protocol.
- When the phone is placed in a position or distance beyond the charging area, it may affect the charging efficiency, or even fail to charge.
- Only one phone can be charged at a time.
- If the phone case is too thick, it may not charge.
- When driving on bumpy road, wireless charging of mobile phone may intermittently stop charging and resume charging.
- If the mobile phone cannot charge normally, make sure that there are no foreign objects in the wireless charging area and the mobile phone is in the charging area, or wait for the wireless charging area to cool before trying again.
- When the temperature of the phone is too high, charging may stop, and it will continue to charge when the temperature of the phone cools down.
- For various mobile phones, their wireless charging coils may be in different locations. Please adjust the mobile phone in the wireless charging area to

find the most suitable charging area for your mobile phone.

Charging the mobile phone wirelessly



If your phone supports wireless charging, you can charge it on the charging pad **1**.

- Before placing the phone in the wireless charging area, make sure that there are no objects on the surface.
- Place your phone on the centre of the charging pad and the wireless charging starts automatically.

Enabling/disabling the wireless charging

Enter the setting interface:

- Tap  > *General* > *Connection* > *Wireless charging* to turn on/off the wireless charging.

Floor mats

Floor mats

⚠ WARNING Risk of accident from incorrectly installed floor mats

- ▶ Use floor mats that are designed for the vehicle module and will not obstruct the pedal area. Failure to follow this instruction could result in loss of vehicle control, resulting in personal injury or death.
- ▶ If the pedals cannot move freely, the vehicle may lose control and increase the risk of serious personal injury.
- ▶ Secure the floor mats to fitting devices, so they cannot slip out of place and interfere with the pedals. Failure to follow this instruction could result in loss of vehicle control, resulting in personal injury or death.
- ▶ Do not place extra floor mats or other covers on top of the already installed floor mats, as this may cause the floor mats to interfere with the operation of the pedals. Failure to follow this instruction could result in loss of vehicle control, resulting in personal injury or death.
- ▶ Store all items in the vehicle properly, so that they cannot get to the position where the driver's feet are. Loose items can get caught under the pedals and cause the vehicle to lose control.



When installing the floor mats, place the floor mats in the correct position, align the floor mat eyelets with the floor mat retaining clips, and then press to lock.

Remove the floor mats in the reverse order of installation.

 Check the floor mats regularly to ensure that they are installed in the correct position.

Exterior lighting

Information about the lighting system and your responsibilities

The vehicle's various lighting systems are only aids. The driver is responsible for adjusting the vehicle's lighting based on road illumination, visibility, statutory requirements and traffic conditions.

Light switch

Operating the light switch

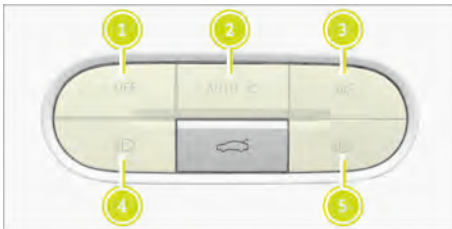

- 1 OFF Switching the lighting off
- 2 AUTO Automatic headlamp
- 3 Position lamp
- 4 Low beam
- 5 Adaptive High Beam/Automatic High Beam

After switching on the vehicle, the indicator **READY** on the driver information display illuminates. Press the switch **OFF** to turn on the daytime running lights and turn off other lights.

After switching on the vehicle, the indicator **READY** on the driver information display illuminates. Press the switch **AUTO**, the position lamps, license plate light, daytime running lamps and low beam will be automatically turned on according to the external light intensity.

Press the switch to turn on the position lamps and license plate light at the same time.

Press the switch to turn on the low beam, position lamps and license plate light at the same time.

Press the switch to turn on Adaptive High Beam/Automatic High Beam.

NOTE Long-time operation of the lamps causes the 12 V battery to lose power.

- ▶ Do not operate the lamps for an extensive period of time when the vehicle is not started.

Use vehicle lights correctly according to local laws and regulations.

Tail lamp

When the liftgate is opened/closed, the tail lamps turn on/off automatically. If the liftgate is not closed for an extensive time, the tail lamps automatically turn off.

Reversing lamp

When the vehicle reverses, the reversing lamps illuminate.

Brake light

When the vehicle brakes, the brake lights illuminate.

Operating the combination switch

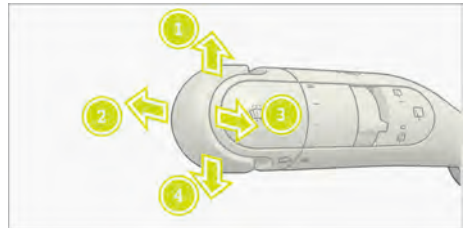

- 1 Right turn signal lamp
- 2 High beam
- 3 High beam flashing
- 4 Left turn signal lamp

Turning on the high beam

1. After switching on the vehicle, the indicator **READY** on the driver information display illuminates. Press the automatic headlamp switch **AUTO** or the low beam switch .

2. Turn the combination switch in the direction of the arrow **2**.

When the high beam is turned on, the high beam indicator on the driver information display illuminates.

Turning off the high beam

When the high beam is turned on, move the combination switch in the direction of the arrow **2** again or move the combination switch in the direction of the arrow **3**.

High beam flashing

After switching on the vehicle, the indicator **READY** on the driver information display illuminates. Press the combination switch in the direction of the arrow **3**.

Turning signal light

- Brief flashing:** briefly press the combination switch to the point of resistance in the direction of the arrow **1** or **4**. The turning signal light flashes 3 times.
- Continuous flashing:** press the combination switch past the point of resistance in the direction of the arrow **1** or **4**.

Turning on/off the hazard warning lights

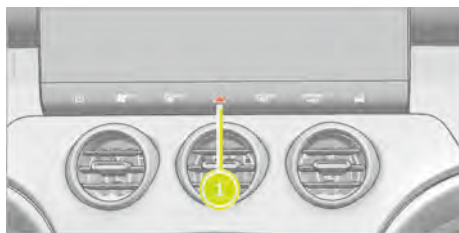

ON/OFF: tap the button **1**.

- i** In case of collision or emergency brake, the hazard warning lights may turn on automatically.

Illumination delayed turnoff

If you open any door after locking the vehicle, the delay will re-time after the vehicle is locked again.

Enter the setting interface:

- Tap > *Lights* > *Environment Light* > *Follow me home* to set the headlamp off delay time to Off, 30 s, 60 s, and 90 s.

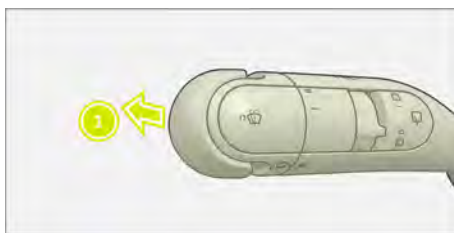

After the illumination delayed turnoff function is turned on, the following situations occur:

- **When the automatic headlamp is not in the **AUTO** state:** toggle the combination switch in the direction of the arrow **1** once, so the headlamps will be turned off at the set delay time after you get off the car.
- **When the automatic headlamp **AUTO** is turned on:** the headlamps will be turned off at the delay time after occupants get off the vehicle.

After getting off the car, the lights stay on according to the set time.

If the vehicle is equipped with side logo lights, they will be on at the same time.

Approach lighting

When you approach the vehicle at night or in a dark environment, approaching light will turn on the low beams, position lamps and licence plate light and keep them on for about 30 seconds. If the vehicle is equipped with side logo lamps and grille lamp, they will light up as well.

Approaching light can be triggered in the following cases:

- **Vehicle detecting a valid key:** when the vehicle detects a valid key, approaching light will be enabled and turn on the corresponding lights.
- **Unlocking the vehicle with the remote key:** when you press the remote key to unlock the vehicle, approaching light will be enabled and turn on the corresponding lights.

Turning on/off approaching light

Enter the setting interface:

- Tap  > *Lights* > *Environment Light* > *Approaching Light* to turn on/off the approaching light.

Automatic turning on/off of the lighting

The automatic headlamp function monitors the ambient light intensity through the sensor. When the light is dim, this function can automatically turn on the low beam, position lamps, rear plate indicator light. When the light is sufficient, they are automatically turned off.

Depending on the configuration, the sensor location is different:

Type I



The rain light sensor is located on the upper part of the front windshield, and the automatic wipers/automatic headlamp/automatic air conditioning control the corresponding functions through this sensor.

Type II



The light sensor is located in the centre of the instrument panel, and the automatic wipers/automatic headlamp/automatic air conditioning control the corresponding functions through this sensor.

Automatic headlamp



Press the button **1** on the instrument panel combination switch on the driver side to turn on the automatic headlamps.

Automatic headlamp is only an aid. The driver is responsible for adjusting the vehicle's lighting based on road lighting, visibility, statutory conditions and traffic conditions.

! NOTE

Never block the rain light sensor/light sensor. Otherwise, the automatic headlamp/automatic climate control function and automatic wiper function may not work properly.

Headlamp leveling adjustment

Type I (for non-matrix headlamp)

Before driving, adjust the headlamp leveling according to the number of occupants and luggage load.

Enter the setting interface:

- Tap  > *Lights* > *Headlight height adjustment* > 3/2/1/0 to adjust the headlamp leveling.

Load	Selection
Driver	0
Driver + front passenger	0
All occupants (driver + front passenger + 3 rear passengers)	1

Load	Selection
At GVW with all occupants (driver + front passenger + 3 rear passengers + rear cargo)	2
At GVW with cargo (driver + rear cargo)	3

Type II (for matrix headlamp)

The headlamp leveling is automatically adjusted according to the vehicle load and suspension movement.

- The headlamp leveling is automatically adjusted when the vehicle is fully loaded/unloaded.
- When the vehicle is in motion and encounters a bumpy road, the headlamp leveling is automatically adjusted

Adaptive front illumination system

The adaptive front illumination system adjusts the light angle or light distribution according to road and environmental conditions to improve road illumination.

The system includes the following functions:

- Corner lighting
- Rural lighting
- Urban lighting
- Highway lighting

The Adaptive High Beam can help the driver observe the road under poor road light conditions, such as nighttime. The Adaptive High Beam is only an aid and it is always your responsibility to adjust the vehicle lighting according to the current light, visibility and traffic conditions.

Corner lighting

Corner lighting provides enhanced lighting on curves.



Corner lighting can provide a wide range of lane lighting effect in the turning direction of the vehicle, making it easier to see the road conditions within the turning range.

It is enabled under the following conditions:

- The automatic headlamp **AUTO** is enabled.
- The driver turns the steering wheel to a certain angle and the vehicle speed is greater than 10km/h(7 mph).

Rural lighting

Low beam headlamps with adaptive light distribution can provide a wider light distribution for driving on rural roads.

It is enabled under the following conditions:

- The automatic headlamp **AUTO** is enabled.
- Turn on the Adaptive High Beam.
- At a certain speed.

Enter the setting interface:

- Tap > *Lights* > and turn on/off the Adaptive High Beam.

Urban lighting

Urban lighting uses more widely distributed light to improve the roadside lighting in densely built areas, which is suitable for urban roads with good light.

This function can expand the low beam vision and make it easier for the driver to observe pedestrians on the roadside.

It is enabled under the following conditions:

- The automatic headlamp **AUTO** is enabled.
- Turn on the Adaptive High Beam.
- At a certain speed.

Enter the setting interface:

- Tap  > *Lights* >  and turn on/off the Adaptive High Beam.

Highway lighting

Highway lighting improves road lighting by increasing the range and brightness of light. Drivers can observe the road ahead to respond in advance and avoid danger.

It is enabled under the following conditions:

- The automatic headlamp  is enabled.
- Turn on the Adaptive High Beam.
- At a certain speed.

Enter the setting interface:

- Tap  > *Lights* >  and turn on/off the Adaptive High Beam.

Adaptive High Beam

⚠ WARNING Despite having Adaptive High Beam, there is still a risk of accident

Adaptive High Beam does not recognize the following road conditions:

- Road users without lighting, such as pedestrians.
- Road users with poor lighting, such as bicyclist.
- Roads with blocked lighting, such as, obstacles.
- ▶ Pay attention to the traffic conditions and turn off the high beams in time.

Adaptive High Beam does not take into account road, weather or traffic conditions.

Detection may be limited in the following cases:

- Poor vision, such as in fog, heavy rain or snow.
- Dirty or covered sensors.

Adaptive High Beam is only an aid and it is always your responsibility to adjust the vehicle lighting according to the current light, visibility and traffic conditions.

After Adaptive High Beam is turned on, some lights are turned off when a forward vehicle is detected, so as to avoid the danger caused by dazzle to the driver of the forward vehicle and improve the safety factor and comfort of driving at night.

Adaptive High Beam automatically switches between the following lamp types:

- Low beam
- Partial high beam
- High beam



Enabling Adaptive High Beam

Press the button  on the instrument panel combination switch on the driver side.

When Adaptive High Beam is enabled, the Adaptive High Beam indicator  on the driver information display illuminates.

Automatic High Beam

⚠ WARNING Risk of accident when Automatic High Beam is enabled

Automatic High Beam cannot recognize the following road conditions:

- Road users without lighting, such as pedestrians.
- Road users with poor lighting, such as bicyclist.
- Roads with blocked lighting, such as, obstacles.
- ▶ Pay attention to the traffic conditions and turn off the high beams in time.

Automatic High Beam does not take road, weather or traffic conditions into account.

Detection may be limited in the following cases:

- Poor vision, such as in fog, heavy rain or snow.
- Dirty or covered sensors.

After Automatic High Beam is turned on, the system switches to low beams when a forward vehicle is detected, so as to avoid the danger caused by dazzle to the driver of the forward vehicle and improve the safety factor and comfort of driving at night.

Automatic High Beam automatically switches between the following lights:

- Low beam
- High beam



Enabling Automatic High Beam

Press the button 1 on the instrument panel combination switch on the driver side.

When Automatic High Beam is turned on, the indicator  on the driver information display illuminates.



Rear fog lamp

When the visibility is poor, such as fog, heavy rain or snow, the rear fog lamps can be turned on.

Requirements for turning on the rear fog lamps:

- The vehicle is in the **READY** mode.
- The light switch low beam  or automatic headlamp **AUTO** is on.

Enter the setting interface:

- Tap  > **Lights** >  to turn on/off the rear fog lamps.

When the rear fog lamps are turned on, the rear fog lamp indicator  on the driver information display illuminates.

Observe the laws and regulations of relevant countries on the use of rear fog lamps.

Reversing lamp

Shift to reverse **R**, and the reversing lamp lights up to provide illumination and warning.

Reversing lamp on requirements: vehicle is in the Ready mode and reverse **R**.

Emergency brake light flash

In case of sudden speed reduction or emergency brake, the brake lamps flash sharply. If the speed drops to 10 km/h (7 mph), the brake lamps will be on and the hazard warning lights will be enabled at the same time.

When the vehicle returns to normal driving, the hazard warning lights stop flashing.

Courtesy light

Exterior courtesy light

When the vehicle is unlocked, the low beam, position lamps and rear plate indicator light are turned on. If the vehicle is equipped with side logo lamps and grille lamps, they will be on as well.

Rearview mirror courtesy light



When the vehicle is unlocked, the courtesy light 1 below the outside rearview mirrors automatically illuminate.

Door sill courtesy light

When any door is opened, the door sill courtesy light automatically illuminates. When the illumination time exceeds 2

minutes or all doors are closed, the door sill courtesy light automatically turns off.

Interior courtesy light

When the vehicle is unlocked and a door is opened, some ambient lamps turn white to provide courtesy function.

Interior lighting

Adjusting the interior lighting

⚠ WARNING Risk of injury if vehicle settings are adjusted while the vehicle is in motion

You could lose control of the vehicle particularly in the following situations:

- If you adjust the driver's seat, steering wheel, or mirrors while the vehicle is in motion.
- If you fasten your seat belt while the vehicle is in motion.
- ▶ Before starting the vehicle, adjust the driver seat, steering wheel and mirrors and wear the seat belt correctly.

Front reading light:

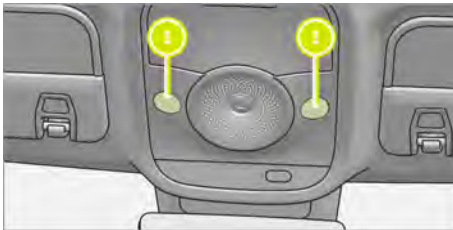

ON/OFF: touch or press the reading light **i** depending on the vehicle configuration.

Depending on the vehicle configuration, press and hold the physical switch of the reading light to adjust the light brightness.

Rear reading light:

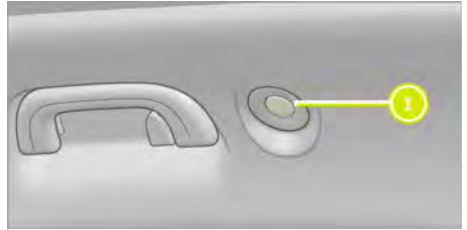

ON/OFF: press the reading light **i**.

Enabling/disabling the reading light from the central display

- Enter the shortcut interface: Swipe downward on the centre display or tap > to turn on/off the reading light.
- Enter the setting interface: Tap > *Lights* > *Reading Light* to turn on/off the reading light.

Boot light

When the boot is turned on/off, the boot light turns on/off automatically.

Glove box lamp

When the glove box is turned on/off, the glove box light turns on/off automatically.

Courtesy light

- Enter the setting interface: Tap > *Lights* > *Environment Light* > *Courtesy Lighting* to turn on/off the courtesy light.

The courtesy light consists of the following 2 types of lights:

- Reading light.
- Foot well light.

Conditions for activating the courtesy light:

- The vehicle is unlocked.
- A door is opened.



The courtesy light turns off when:

- The vehicle is locked.
- All doors are closed.
- The vehicle is in drive **D**, neutral **N**, and reverse **R**.

- The vehicle door remains open for about 2 minutes.
- The courtesy light is turned off on the centre display.

Adjusting the ambient lighting

Ambient light is used to ensure that the interior of the car is not too dark during driving, and also to create a pleasant driving environment.

- Enter the shortcut interface:
Swipe down on the centre display or tap  to enter the Quick Controls interface. The lower right part of the Quick Controls interface is the ambient light theme selection area. The user can select the corresponding ambient light theme according to preference.
- Enter the setting interface:
Tap  > *Ambient Light* and the user can choose the corresponding ambient lighting theme according to preference, and you can also customize the colour of the ambient light.

Courtesy ambient light: when the vehicle is powered off, the ambient light is turned off automatically. When the vehicle door is opened, the ambient light turns on the courtesy effect.

Voice interaction ambient light: after the voice interaction ambient light is turned on, the ambient light changes according to the voice interaction.





Climate control & ambient light interaction: some of the ambient lights change states according to the climate control adjustment, and recovers after adjustment.

Range reminder ambient light: after turning on the range reminder ambient light, if the remaining range is below a certain extent, the ambient light flashes in orange and then turns to normal.

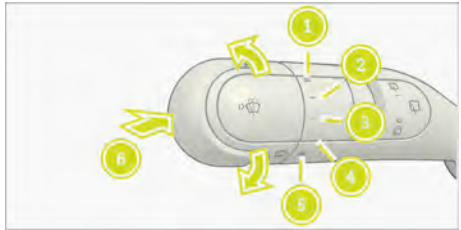
Windscreen wipers and washer system

Operating the front wiper



- 1  Continuous wiping, fast
- 2  Continuous wiping, slow
- 3  Intermittent wiping, fast
- 4  Intermittent wiping, standard
- 5  Front windscreen wiper off

Turn the combination switch to the corresponding position 1 – 5.

- To wipe once: push the button on the combination switch in the direction of the arrow 6 to the point of resistance.
- To wipe with the front windscreen washer: push the button on the combination switch in the direction of the arrow 6 past the point of resistance.

For vehicles equipped with rain sensor, turn the combination switch to the position 3 or 4 to enable the automatic wiper according to the rainfall.

For vehicles without rain sensor, turn the combination switch to the position 3 or 4 to enable the automatic wiper according to the vehicle speed.

- ① Frozen washer fluid can prevent the washer system from functioning due to cold climate. If the washer fluid lines are frozen, never use the washer to avoid damage.
- ① When the front wiper is turned on, if the driver's door is opened or nobody is in the driver's seat, the front wiper will stop working to prevent splashing water on the driver.

- ① When the front wiper moves to the 90° position, press and hold the front washer nozzle switch to activate the front washer nozzle for fluid spraying.

Operating the rear wiper

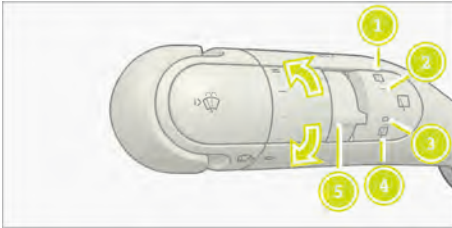

- ① Wiping with rear windscreen washer fluid
- ② Enable the rear wiper
- ③ Disable the rear wiper
- ④ Wiping with rear windscreen washer fluid

Turn the switch ⑤ to the corresponding position ① – ④

- ① Frozen washer fluid can prevent the washer system from functioning due to cold climate. If the washer fluid lines are frozen, never use the washer to avoid damage.

Rear wiper auto activation setting

Enter the setting interface:

- Tap > *Vehicle Settings* > *Vehicle Control* > *Rear wiper off while reversing* to enable/disable the rear wiper off while reversing function.

After this function is turned on, when the front wiper is working, and at the same time, if the driver shifts into **R** gear, the rear wiper will be turned on automatically.

Front wiper maintenance mode

Turn off and set the front wiper to the maintenance mode when replacing or repairing front wiper.

Setting the front wiper to the maintenance mode:

Enter the setting interface:

Tap > *Vehicle Condition* > *Front Wiper Maintenance Mode* to turn on/off the Front Wiper Maintenance Mode.

- ① Before enabling the front wiper maintenance mode, set the front wiper switch to the OFF position.

Replacing the front wiper blades

⚠ WARNING Risk of being trapped if the wipers are switched on while wiper blades are being replaced

If the wipers begin to move while you are replacing the wiper blades, you can be trapped by the wiper.

- ▶ Make sure to switch off the wipers before replacing the wiper blades.

Removing the wiper blades

1. Set the front wiper to the maintenance mode (→ Page 75).
2. Fold the wiper arm away from the front windscreen.



3. Hold the wiper arm with one hand, press the clip inward along the direction of the arrow ①, and pull the blade out along the direction of the arrow ② with the other hand.

Installing the wiper blades



1. Align a new wiper blade with the wiper arm along the direction of the arrow **1** and slide the clip into the locked position.
2. Make sure the wiper blade is seated properly.
3. Carefully fold the wiper arm back onto the front windscreen.
4. Start the vehicle.
5. Exit the front wiper maintenance mode and the front wiper arms return to the original positions.

Replacing the rear wiper blade

⚠ WARNING Risk of being trapped if the wipers are switched on while wiper blades are being replaced

If the wipers begin to move while you are replacing the wiper blades, you can be trapped by the wiper.

- ▶ Make sure to switch off the wipers before replacing the wiper blades.

Removing the wiper blade

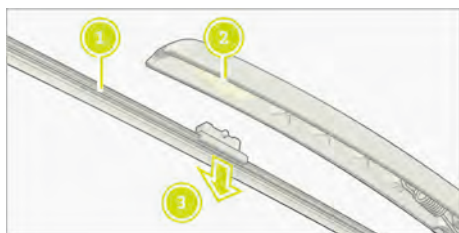

1. Fold the wiper arm away from the rear windscreen.
2. Remove the wiper blade **1** from the wiper arm **2** along the direction of the arrow **3**.

Installing the wiper blade

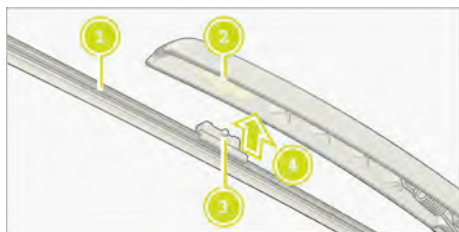

1. Place the wiper blade **1** onto the bracket of wiper arm **2** through the 2 lugs **3**.
2. Push the wiper blade **1** along the direction of the arrow **4** until it is loaded to the bracket **2**.
3. Make sure the wiper blade **1** is seated properly.
4. Carefully fold the wiper arm back onto the rear windscreen.

Rearview mirrors

Adjusting the outside rearview mirrors

⚠ WARNING Risk of injury if vehicle settings are adjusted while the vehicle is in motion

You could lose control of the vehicle particularly in the following situations:

- If you adjust the driver's seat, steering wheel, or mirrors while the vehicle is in motion.
- If you fasten your seat belt while the vehicle is in motion.
- ▶ Before starting the vehicle, adjust the driver seat, steering wheel and mirrors and wear the seat belt correctly.

Enter the setting interface:

- Tap  > *Quick Controls* > *Exterior Mirrors*, and operate the direction buttons on the right side of the steering wheel to adjust the rearview mirrors.

When the seat memory is enabled and a seat position is stored, the position of the outside rearview mirrors is memorized synchronously. When the seat memory function is used next time, the outside rearview mirrors will be automatically adjusted to the memorized position.

- ⓘ The memorized position will change as personal accounts being switched.

Automatic anti-dazzle of the outside rearview mirrors

The outside rearview mirrors have automatic anti-dazzle function. The lenses reduce the brightness of the light reflecting from the rearview mirror, so as to achieve anti-dazzle function.

Manual anti-dazzle of the inside rearview mirror

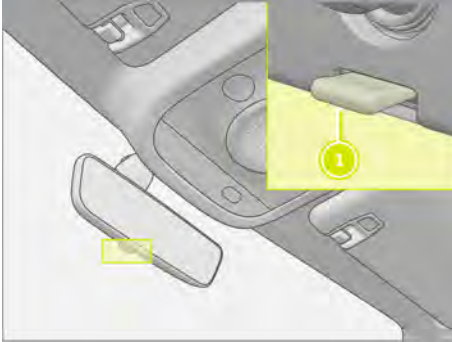

Push the handle ❶ at the bottom of the inside rearview mirror to change the view angle to achieve anti-dazzle function. Pull back the handle ❶ to return the inside rearview mirror to the normal position and disable the anti-dazzle function.

Automatic anti-dazzle of the inside rearview mirror

The automatic anti-dazzle function of the inside rearview mirror can sense the rear light and automatically dim the reflected light from the inside rearview mirror.

The automatic anti-dazzle function is disabled under any of the following conditions:

- Reverse gear is engaged.
- The vehicle is powered off.

NOTE

- ▶ The automatic anti-dazzle function works only when the incoming light of the inside rearview mirror is not affected by other objects.
- ▶ To prevent the function of inside rearview mirror from being impaired, pasting labels or installing a driving recorder on the lens of the inside rearview mirror is prohibited.

Adjusting the inside rearview mirror manually

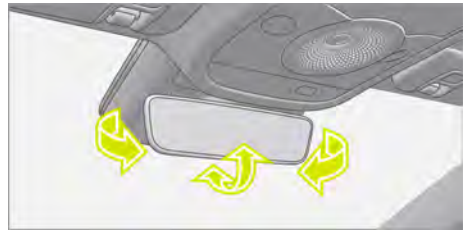

The inside rearview mirror is fixed to the front windscreen and can be turned in the direction of the arrow to the required position.

Outside rearview mirror heating

Press the rear windscreen defrost button  below the centre display, the button indicator illuminates, and the outside rearview mirror heating and rear windshield defrost are turned on at the same time.

Outside rearview mirror folding

The folding function of the outside rearview mirror is convenient for driving through a narrow roadway and parking.



Automatically fold exterior mirrors when locking car

Enter the setting interface:

- Tap  > *Vehicle Settings* > *Vehicle Control* > *Auto-fold exterior mirrors while locking* to turn on/off the auto-fold exterior mirrors while locking function.



- ⓘ In cold weather, the outside rearview mirror may freeze preventing it from folding. It is recommended you disable the automatic rearview mirror folding function in cold weather.

Folding/unfolding the outside rearview mirrors from the centre display

- Enter the shortcut interface: Slide downward on the centre display or tap  >  to fold/unfold the outside rearview mirrors.

Angle down exterior mirrors when reversing

Enter the setting interface:

- Tap  > *Vehicle Settings* > *Vehicle Control* > *Driver-side outside mirror tilt-down while reversing* to turn on/off the driver-side outside mirror tilt-down while reversing function.
- Tap  > *Vehicle Settings* > *Vehicle Control* > *Passenger-side outside mirror tilt-down while reversing* to turn on/off the passenger-side outside mirror tilt-down while reversing function.

When the vehicle is in reverse **R**, the outside rearview mirrors automatically tilt down, so that the driver can better observe the road condition behind.

- ⓘ In cold weather, the outside rearview mirror may freeze preventing it from folding. It is recommended you disable the automatic rearview mirror folding function in cold weather.

Sunvisor

Operating the sun visors

There are sun visors above the driver and front passenger. When the sun shines on the vehicle from the front or both sides of the vehicle, the sun visors can be flipped down or pulled out from the retaining clip and turned to the side to block the sun.

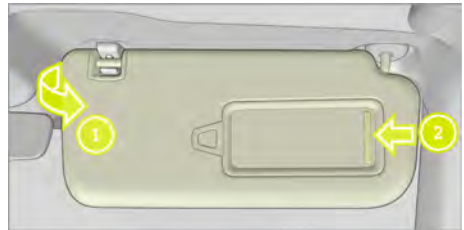

Pull it out from the retainer in the direction of the arrow **1** and swing it toward the door.

When the vanity mirror cover **2** is opened, the mirror lamp is turned on.

Overview of the climate control system

Physical buttons of the climate control

Enable the corresponding functions of the climate control by operating the climate control physical buttons.

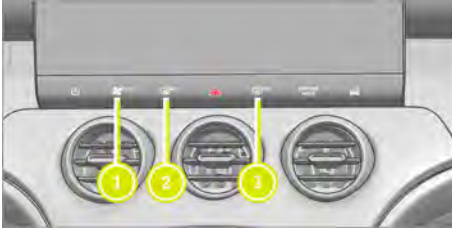

- 1 Setting the Climate Control to the AUTO mode.
- 2 Turning on/off the windscreen defrosting in highest position.
- 3 Turning on/off the rear windscreen and outside rearview mirror defrosting.

Climate control interface on the centre display

Common climate control functions can be used through the climate control interface.



- 1 Air conditioning fan speed adjustment (→ Page 79).
- 2 Driver seat heating and ventilation (if equipped), and steering wheel heating control (if equipped).
- 3 Driver and passenger seat temperature control.
- 4 Front passenger seat heating and ventilation functions (if equipped).

Enter the climate control interface:

Swipe upward on the centre display or tap



to enter the climate control interface.

According to the vehicle configuration, the climate control interface is divided into several tabs. Tap the corresponding title to switch between tabs.

Operating the climate control system

Turning on/off the climate control

To turn on the climate control

- Tap on the climate control interface to pop up the slide bar, and set the air volume to any position but 0 to turn on the climate control.
- Tap the temperature control button on the driver or passenger side to turn on the climate control.
- On the climate control interface, tap , , or to turn on the climate control.
- Tap to turn on the climate control.
- Tap to turn on the climate control.
- On the climate control interface, tap , , , or to turn on the climate control.

To turn off the climate control

- Tap to pop up the slide bar, and set the air volume to the 0 position to turn off the climate control.
- Press and hold 5 seconds to turn off the climate control.
- On the climate control interface, tap to turn off the climate control.

Setting the climate control to AUTO

In the AUTO mode, the interior of the vehicle is kept at a constant temperature.





Tap to enable the climate control AUTO mode.

- ⓘ When the climate control is enabled, it is recommended to select the AUTO mode to optimize the comfort.

Adjusting the air flow direction

Tap or swipe upward on the centre display to open the climate control interface, and adjust the climate control air flow

direction by the icons on the climate control interface:

-  Windscreen outlet.
 -  Face outlet.
 -  Foot outlet.
-  You can select multiple air flow directions at the same time, such as setting the windscreen and floor air flows at the same time.

Setting the air circulation mode

Tap  to switch to the recirculation/intelligent circulation/fresh air according to needs.

-  If the internal circulation is enabled in winter, the windows may get foggy. The automatic circulation is recommended.

Front windscreen defrosting

Tap the button  in the centre display physical button area to enable the front windscreen defrosting to remove the icing and frost on the front windscreen and windows quickly.

WARNING

For safety, make sure that there is no ice slag, snow or water condensation on the front windscreen. It is very important. Otherwise, the vision can be blocked and accidents may occur.

Rear windscreen defrosting

Tap the button  in the centre display physical button area to enable the rear windscreen defrosting to remove the icing and frost on the rear windscreen and outside rearview mirrors.

The indicator light illuminates when the function is turned on. The function turns off automatically and the indicator goes out after running for a while.

WARNING





For safety, make sure that there is no ice slag, snow or water condensation on the front windscreen. It is very important. Otherwise, the vision can be blocked and accidents may occur.

Enabling/disabling the front seat heating

WARNING

Do not use the front seat heating function if you or the passengers are sick, disabled, unconscious, etc., and cannot sense the seat temperature physically.

Enabling/disabling the front seat heating

1. To turn on/increase level: tap  or  on the centre display until the desired heating level is reached. Depending on the heating level, up to 3 indicators can be lit.
2. To turn off/lower level: tap  or  on the centre display until the desired heating level is reached; if all indicators are off, it shows that the seat heating is turned off.





-  The highest level is the default level when the function is enabled. Tap the button to lower the level at a time until it is turned off.

Setting the driver/passenger seat heating time

Enter the setting interface:

- Tap  > *Vehicle Settings* > *Comfort* to set the driver/front passenger's seat heating time to 5 min, 15 min, 30 min, and Constant.

Enabling/disabling the front seat ventilation (if equipped)

1. To turn on/increase level: tap  or  on the centre display until the desired ventilation level is reached. Depending on the ventilation level, up to 3 indicators can be lit.
2. To turn off/lower level: tap  or  on the centre display until the desired

ventilation level is reached; if all indicators are off, it shows that the seat ventilation is turned off.

- ① The highest level is the default level when the function is enabled. Tap the button to lower the level at a time until it is turned off.

Enabling/disabling the steering wheel heating (if equipped)

1. **Enabling/increasing level:** tap  on the centre display until the desired heating level is reached. You can also set the desired heating level by voice control.

Depending on the heating level, up to 3 indicators can be lit.

2. **Disabling/decreasing level:** tap  on the centre display until the desired heating level is reached; if all indicators are off, it means that the steering wheel heating is turned off. You can also turn off/lower the heating level by voice control.

- ① The highest level is the default level when the function is enabled. Tap the button to lower the level at a time until it is turned off.

Climate control setting

Tap  to open the climate control setting interface.

Overheat protection

Turn on/off Cabin Overheating Prevention. After the function is turned on, the system cools the cabin when the inside temperature is too high.

- ① After 24 hours, this function is automatically turned off, and it cannot be activated if the SOC is lower than 20%.

Window Auto-Close Reminder

Turn on/off Window Auto-Close Reminder.

Auto Air Purification

Turn on/off Auto Air Purification.

Operating the climate control

Climate control interface on the centre display

The functions of the climate control indicated on the centre display can be found in ① to ③.

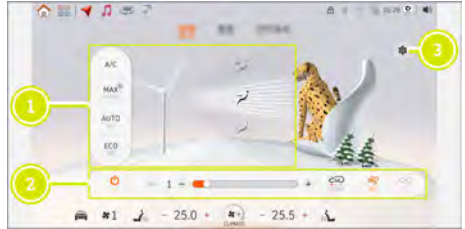



MAX Enable/disable the maximum air conditioning.

A/C Enable/disable air conditioning.

AUTO Enable/disable the climate control AUTO mode (→ Page 79).

ECO Enable/disable the climate control ECO mode.

 Set the air flow direction toward the windscreen.

 Set the air flow direction toward the face.

 Set the air flow direction toward the foot.

 Turning on/off the climate control (→ Page 79).

 Switching between recirculation/intelligent circulation/fresh air.

 Turn on or off the A/C ventilation function to realize natural ventilation.

 Open the setting interface (→ Page 81).



Interior air quality system (if equipped)

The air quality system (AQS) consists of a multi-layer filter, an AQS sensor, and a PM2.5 sensor. The filter removes smoke and solid particles from the inlet air, so as to reduce odors and pollutants entering the vehicle.

The AQS sensor can monitor the air quality outside the car. When pollutants are detected, the external air circulation inlet

port is closed, and the internal air circulation is turned on for the air inside the passenger compartment to prevent the air inside from being polluted.

The PM2.5 sensor monitors the solid particles of the air in the vehicle. When it detects that the particle pollution is serious, it turns on the external air circulation to reduce the pollution in the vehicle.

1. Open the climate control interface (→ Page 79).
2. Tap air quality to check the current PM 2.5 inside the vehicle and the AQS air quality level outside the vehicle.
3. Tap  to turn on the intelligent fresh air mode.
4. Tap  to turn on the deodorization.

In order for the climate control and air filtration to work normally, use the air conditioning filter element. Make sure that the air conditioning filter element is properly installed and its housing is properly sealed in the front compartment. It is recommended to have the maintenance carried out at a smart Authorized Service Partner.

Air vents

⚠ WARNING Risk of burns or frostbite due to insufficient distance from the air outlet

The air outlet may blow out overheated or freezing air.

This may cause burns or frostbite to people near the air outlet.

- ▶ Make sure that the occupants inside keep a sufficient distance from the air outlets.
- ▶ If necessary, guide the air flow to other areas in the vehicle.

To make sure that fresh air enters the vehicle through the air outlet, observe the following:

- Make sure that the air outlet and ventilation grille inside the vehicle are unimpeded.
- Make sure the air inlet is free of dirt such as ice, snow and leaves.

Adjusting the front air outlet



1. **Adjusting the air outlet on the driver's side:** move the slider **1** up, down, left and right. Turn the slider **1** to the leftmost position to close the air outlet.
2. **Adjust the front passenger side air outlet:** turn the slider **2** up and down, left and right to adjust the air outlet direction. Turn the slider **2** to the rightmost position to close the air outlet.

Adjusting the rear air outlet

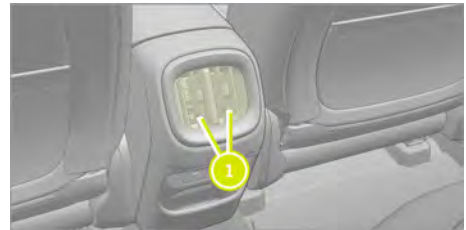

1. **Adjusting the rear air outlet:** move the slider **1** up, down, left and right. Turn the slider **1** down to the maximum position to close the air outlet.

Armrest box ventilation

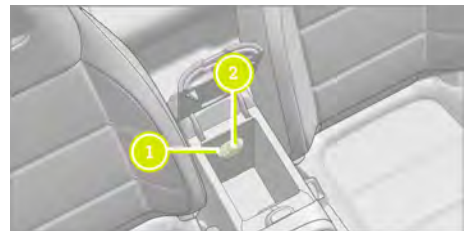

- 1** Air outlet adjusting switch
- 2** Air vents

1. Open the armrest box.

2. **Opening/closing the air outlet:** turn the roller  clockwise/counterclockwise to open/close the air outlet.

 To use the armrest box air outlet function, first enable the climate control.

Charging the high voltage battery

Notes on high voltage battery charging

Note the following when charging the high voltage battery:

- Check the charging cable before charging the vehicle. Never use a charging cable with damaged skin or shell.
- Before charging, make sure that there is no water or foreign objects in the charging port of the vehicle, power supply equipment and charging connection device, and the metal terminal is not rusted or corroded.
- Charge the vehicle in a safe environment. Avoid rain and water immersion and stay away from fire sources.
- Never disassemble or modify the charging equipment or related ports by yourself.
- Choose a dry and ventilated environment. Never use the charging equipment in an environment where gasoline, paint, flammables or explosives are used or stored.
- Never use the charging cable in a dark or humid place.
- Never allow children to charge the vehicle.
- Never touch the charging port.
- Never charge the vehicle in rainy days if there is no awning.
- In case of sudden weather change (gale, rain, snow and thunderstorm) when charging outdoor, check whether the charging gun is well connected and dry. During thunder and lightning, never touch the charging cable or vehicle body.
- In case of moisture near the charging port, first make sure it is safe, then cut off the power supply and disconnect the charging gun (never touch the metal part of the charging socket with your hand or other parts of your body). If necessary, use insulated gloves and contact a smart Authorized Service

Partner for inspection as soon as possible.

- If the vehicle emits peculiar smell during charging, stop charging immediately.
- When charging, never squeeze the charging cable.
- After charging, never disconnect the charging connection device when your hands are wet or standing in water.
- Make sure that the charging connection device is disconnected from the vehicle charging port before operating the vehicle.

⚠ WARNING Risk of fatal injury from damaged components

At charging stations with a pre-installed charging cable:

- **Visually check the charging equipment for obvious faults, such as extensive damage to the housing or charging cable.**
- **Always observe the safety notes on the charging station.**

At charging stations without a pre-installed charging cable:

- For safety reasons, only use charging cables that have been tested and approved by the manufacturer for charging the high voltage battery in an electric vehicle.
- Never use damaged charging cables.
- Never stretch the charging cable.
- If an adapter is needed, only use adapters that have been tested and approved as suitable for charging electric vehicle high voltage batteries. Observe adapter manufacturer's operation and safety instructions during operation.

NOTE Accelerated aging of the high voltage battery due to frequent charging to full

Do not charge the high voltage battery to full frequently.

- ▶ For vehicles equipped with the ternary lithium-ion high voltage battery, charge the high voltage battery to 80% when possible.
- ▶ For vehicles equipped with the lithium iron phosphate high voltage battery, fully charge the high voltage battery to 100% at least once a week.

i The vehicle shall not be exposed to the environment with the temperature below -30°C or above 60°C for more than 24 hours.

The following methods can be used to reduce the energy consumption of the vehicle:

- Drive gently.
- Use the electrical equipment reasonably.
- Maintain the vehicle periodically.

The charging time of a high voltage battery may vary throughout its service life.

- i** You can check the state of charge on the centre display.
- i** If the high voltage battery charging time is longer than usual, check the maximum AC charging current setting on the centre display.

Vehicle charging port and charging methods

The high voltage battery can be charged with either alternating current or direct current.

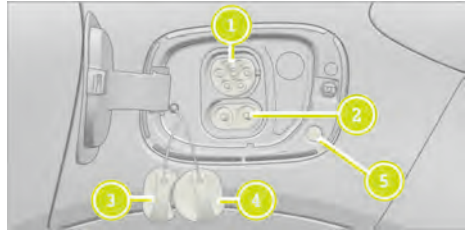

- 1** Charging socket for AC charging.
- 1 2** Charging sockets for DC charging.
- 3** Charging socket cap for DC charging.
- 4** Charging socket cap for AC charging.
- 5** Charging port indicator.

High voltage battery charging options:

- Charging with regenerative energy during driving.
- Charging with alternating current.
- Charging with direct current.

System limitation

The power output of high voltage battery can be affected by the following factors:

- High or low temperature outside of the vehicle.
- Not being charged for a long time.

The charging time of the high voltage battery may vary with the following factors:

- High or low temperature outside of the vehicle.
- Not being charged for a long time.
- The maximum available charging current of the charging facility.
- Charging setting of the vehicle.

Travel schedule



⚠ WARNING Risk of interference caused by the centre display

You may be distracted if you operate the integrated information and communication equipment while driving. You could lose control of the vehicle.

- ▶ Note the road and traffic conditions, stop the vehicle safely, and then operate the centre display.

Charging

Enter the energy management interface:

- Swipe leftward from the right on the centre display or tap  to enter the application interface, and tap  to enter the energy management interface.

When charging the vehicle, choose Daily Trip Mode, Long Trip Mode and Charging reservation.

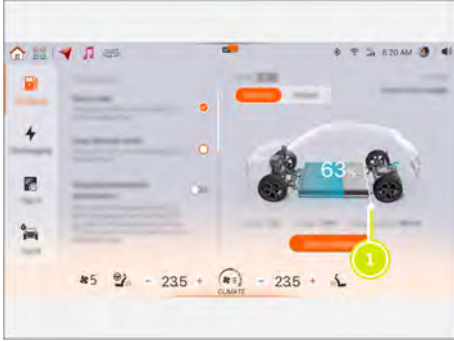

Charging schedule: the user can set the charging schedule on the centre display, and slide the bar leftward or rightward to set the target SOC. Based on the start and end time of charging set by the user and the set target SOC, the vehicle can charge the battery to the target SOC.

In order to make sure that the vehicle can obtain sufficient electric energy before traveling, plug in the charging gun and activate the charging pile in time.



1. Slide  leftward or rightward to set the target SOC value.
2. Tap "Schedule Charging Time Setting" to enter the charging schedule time setting interface.
3. The user can set the start and end time of charging as needed, and tap "Save". If the "Charging ends after reaching target SOC" switch is turned on, the charging process will not end when it is the end time of the charging schedule and the high voltage battery is not charged to the target SOC. In this case, the charging process will continue to reach the target SOC before ending.

4. Tap  to delete the currently reserved travel time.

Travel schedule

The user can make an appointment for travel time by tapping the "Travel Schedule" and setting the travel time (everyday, once, working days and weekend). After that, the vehicle will turn on the battery temperature adjustment and cab temperature control functions in advance according to the set travel time.



Enter the energy management interface:

- Tap  >  > *Charge*, and tap Travel Schedule Settings.

Battery warm-up

The user can turn on/off the battery warm-up on the centre display. After the function is turned on, the system adjusts the temperature of the high voltage battery 1 hour before travel to make sure that the high voltage battery has good performance during travel.



Enter the energy management interface:

- Tap  >  > *Charge* > *Travel Schedule Settings*, and turn on/off the battery warm-up function.

Schedule Air Conditioner

The user can turn on/off the Climate Control on the centre display. After the function is turned on, the automatic Climate Control will start and adjust the temperature to about 22 °C 15 minutes before the travel schedule. After getting in the car, the automatic Climate Control for the travel scheduled is turned off, and the Climate Control returns to the setting of the previous trip. When the set travel schedule time is reached and the driver's door is not opened, the automatic Climate Control for the travel schedule is turned off. If the seat heating/steering wheel heating functions are provided, they are turned on synchronously when the temperature inside the car is lower than 7°C.

Enter the energy management interface:

- Tap  >  > *Charge* > *Travel Schedule Settings*, and turn on/off the Climate Control schedule.

You can also make a schedule through the mobile APP. Please check the mobile APP for specific operation.

Function of the charging port indicator

Description of indicator status

Status	Indicator color
Standby	White
Heating	Yellow
Charging schedule	Blue
Charging	Flashing in green
Charging completed	Green
Malfunctioning	Red
Discharging	Flashing in blue

Start charging

⚠ WARNING Risk of injury due to charging with damaged charging equipment

If charging with damaged charging cable, vehicle charging port or power supply socket, you could suffer an electric shock.

- ▶ Only use an undamaged charging cable.
- ▶ Avoid mechanical damage that may be caused by squashing, bending or driving over the cable.
- ▶ Have a damaged vehicle charging gun replaced at a smart Authorized Service Partner as soon as possible.
- ▶ Never connect the charging cable to a damaged vehicle charging port.

! NOTE Charging cable heating up

Charging cables may heat up within a permissible limit during the charging process.

Observe the permissible limits, so as to make sure:

- that the power equipment and the charging cable are not damaged.
- Follow the operating instructions of charging cable and control device on the charging cable.
- ▶ In case of overheating of the charging cable or the charging gun cable plug, have the equipment of the main power supply checked.

! NOTE Damaged or contaminated charging port

- ▶ Keep the charging port cover and socket cap closed when not in use. The charging port can be protected against contamination and damage.
- ▶ Check and confirm the charging socket cap is closed properly before closing the charging port cover. Otherwise, the charging port cover may be damaged and unable to be opened again.

Charging requirement:

- The vehicle is in park **P**.
- The charging port cover is unlocked
- The drive system is not started.
- The charging cable is not stretched.

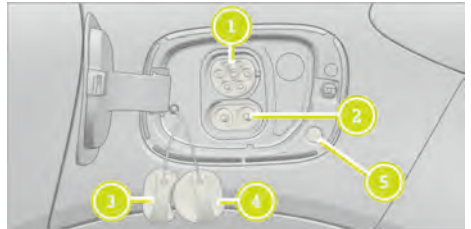

Charging with alternating current:

1. Press and open the charging port cover.

2. Remove the charging socket cap ④.
3. Connect the charging gun to the charging socket ①, turn on the charging pile after the charging gun is locked, and the charging starts with the indicator ⑤ flashing in green.

Charging with direct current:

1. Press and open the charging port cover.
2. Remove the charging socket cap ③ ④.
3. Connect the charging gun to the charging socket ① and ②, turn on the charging pile after the charging gun is locked, and the charging starts with the indicator ⑤ flashing in green.

When the charging starts, the driver information display indicates the battery level and the estimated charging information. The estimated charging information refers to the estimated battery level at the set departure time from the beginning of the charging, or the time required to charge the high voltage battery to a set level.

If the charging cable is connected to the vehicle, the drive system cannot be started and the vehicle cannot be moved.

① When the vehicle is switched on during charging, a charging indicator appears next to the battery level on the driver information display. Be aware of any information displayed on the driver information display.

① Depending on the temperature, you may hear the fan and the battery cooling system running in the charging process.

① If the vehicle is left unused for an extensive period of time and is connected to a power source, the charging system will charge the vehicle automatically as needed.

Stop charging

To stop charging:

1. Stop charging from the centre display or the charging pile.
2. Remove the charging gun from the charging socket.

3. Put back the charging socket cap and close the charging port cover.

① Unlock the vehicle before removing the charging gun, or the charging gun may not be able to be pulled out.

Unlocking the charging gun in an emergency

! **NOTE** Notes on unlocking the charging gun in an emergency

- ▶ Emergency unlock can only be used when the charging gun cannot be pulled out by conventional vehicle unlocking methods.
- ▶ When using the ring-pull of the emergency unlock, please be careful to control the force you apply to avoid pulling too hard.
- ▶ The pull stroke of the ring-pull is about 10mm. Continuous pulling or pulling forcefully with tools may damage the ring-pull or the charging equipment.
- ▶ If you are still unable to pull out the charging gun after using the emergency unlock, contact a smart Authorized Service Partner.

1. Open the boot floor cover.



2. Open the charging gun emergency unlock cover ①.

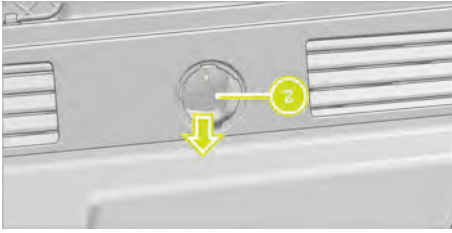

3. Pull the ring-pull **2** downward to unlock the charging port.

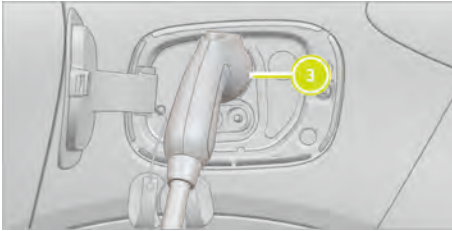

4. Pull the charging gun **3** outward.

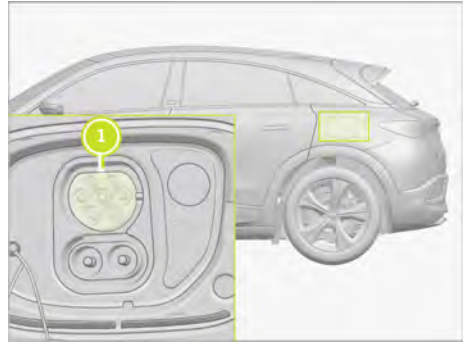

Vehicle discharging port location **1**.

Vehicle as power source

The vehicle can be used as a power source for household appliances such as light, low-power oven and microwave oven.

Enter the energy management interface:

Swipe leftward from the right on the centre display or tap to enter the application interface, and then tap to enter the energy management interface.

- After the V2L charger is plugged, click "Vehicle to Load" to enable the vehicle to load charging function.
- You can also view the vehicle-to-load charging logs.

Swipe on the dotted line on the car model and select the target SOC when the Vehicle to Load stops. In the Vehicle to Load process, if the power battery reaches the set target SOC, it will automatically stop Vehicle to Load.

Vehicle discharging

Vehicle discharging port location

⚠ WARNING Risk of accident due to not understanding or incorrectly using vehicle discharging

Discharging a vehicle using unsuitable discharging equipment, in an improper discharging environment, or with inappropriate discharging operations can cause damage to the vehicle or injury to the personnel.

- ▶ Be sure to read all the topics related to vehicle discharging in the Vehicle Discharging chapter of the complete User Manual to understand the factors such as the function limitations of vehicle discharging. Understand the knowledge you should have before using the system.

Notes on using the vehicle as a power source

⚠ WARNING Risk of accident caused by using the vehicle as a power source

Never use the vehicle as a power source under the following circumstances:

- Tying up the discharging cable, causing it to overheat.
- Using a damaged discharging gun or equipment, which can lead to electric leakage or personal injury.
- Using the vehicle as a power source in unsafe environments, such as during rain or snow.

- Exceeding the vehicle's power supply limit.

Safety Guidelines:

- ▶ The combined power of all electronics must not exceed the rated power of 3.3 kilowatts.
- ▶ If the discharging gun is moist, stop using it immediately. Regularly clean foreign objects, such as dust.

- ① If the state of charge is less than 20%, the vehicle stops supplying power automatically.

Driving

Notes on electric vehicles

⚠ WARNING Risk of chemical burns and poisoning from damaged high voltage battery

If the housing of the high voltage battery has been damaged, electrolyte and gases may leak out.

- ▶ Prevent battery acid from contacting with the skin, eyes or clothing.
- ▶ Immediately rinse electrolyte splashes off with water and seek medical attention straight away.

⚠ WARNING Risk of explosion from excessive internal pressure of the high voltage battery

In the event of a vehicle fire, the internal pressure of the high voltage battery could exceed the critical value. In this case, flammable gas may escape and may be ignited.

- ▶ Stop the charging process immediately in case of unusual odours, smoke or burn marks.
- ▶ Keep away from dangerous areas immediately, and call the fire service.

Observe the following notes on vehicle noise emission and low speed warning:

- The vehicle is equipped with a pure electric drive system, which generates significantly less noise comparing to gas powered vehicles. Therefore, the vehicle is equipped with a low speed warning function.
- When the vehicle moves forward or backward at a speed lower than 20 km/h (13 mph), the low speed warning alerts pedestrians. This helps other road users (particularly pedestrians and cyclists) to hear your vehicle better.
- When the vehicle moves at a speed over 20 km/h (13 mph), the low speed warning is switched off.

- Despite the low speed warning, in some cases pedestrians or other vehicles may not be able to hear your vehicle moving, and it is always your responsibility to drive your vehicle safely.
- The low speed warning is turned off when the vehicle is stationary.

Notes on driving

⚠ WARNING Risk of accident due to objects in the driver's footwell

Objects in the driver's footwell may impede pedal travel or block a pressed pedal.

This jeopardises the operating and road safety of the vehicle.

- ▶ Stow all objects in the vehicle securely so that they cannot get into the driver's footwell.
- ▶ Always fix the floor mats securely in order to make sure that there is always sufficient room for the pedals.
- ▶ Never use loose floor mats, nor place a floor mat on another one.

⚠ WARNING Risk of accident due to unsuitable footwear

Operating the pedals may be impaired by wearing unsuitable footwear, for example:

- Platform shoes
- High-heeled shoes
- Slippers
- ▶ Always wear suitable footwear when driving so that you can operate the pedals safely.

⚠ WARNING Risk of accident or injury due to driving under the influence of alcohol and drugs

Driving under the influence of alcohol or drugs is very dangerous. Even small amount of alcohol or drugs may affect your reaction, perception, and judgment.

Driving under the influence of alcohol or drugs may dramatically increase the probability of a serious or even fatal accident.

- ▶ Never drive or allow others to drive under the influence of alcohol or drugs.

⚠ WARNING Risk of accident due to the brake system overheating

If you leave your foot on the brake pedal when driving, the brake system may overheat.

This increases the braking distance and the brake system may even fail.

- ▶ Never use the brake pedal as a footrest.
- ▶ Never press the brake pedal and the accelerator pedal at the same time while driving.

⚠ WARNING Vehicle damage due to fail to observe the maximum allowable height

If the height of the vehicle is greater than the maximum allowable height (road, garage, etc.), the roof and other parts of the vehicle may be damaged.

- ▶ Observe the height instructions on road signs or other signs.
- ▶ If the vehicle height is greater than the maximum permitted height, do not enter.
- ▶ When using additional roof equipment, pay attention to the total height of the vehicle.

Notes on driving under trailer or fully-loaded conditions

In case of driving with a trailer coupled or under fully-loaded condition, the driving and steering characteristics of the vehicle will change. The following should be kept in mind:

- Do not exceed the maximum allowable towing capacity of the vehicle. Technical data in this manual shall be followed.
- Drive carefully and avoid sudden starts, sudden braking, sudden steering and fast turning.

Notes on driving on wet and slippery roads

Once there is water on the road, hydroplaning may occur. In case of heavy rain or other weathers that may result in hydroplaning, observe the following precautions:

- Reduce the speed
- Avoid tyre tracks
- Avoid sudden steering movements
- Brake gently

Notes on braking on salt-treated roads

The braking effect is limited on salt-treated roads:

- When driving on salt-treated roads, a layer of salt may form on the brake discs and pads. This increases the braking distance or results in only one side of brake functioning normally.

Maintain a greater safe distance to the vehicle in front.

Prevent salt build-up:

- Apply the brake frequently and pay attention to the traffic conditions.

Fording

⚠ WARNING Risk of accident due to fording

Never attempt to pass through deep or moving water. Failure to observe this instruction may result in loss control of vehicle personal injury or death.

Driving through a flooded area may cause vehicle damage. Check the water depth before driving through the flooded area. It is strictly prohibited to pass through flooded area with water depth exceeding the lower edge of car body.

When driving through flooded areas, drive slowly and do not stop. Braking performance and grip may be limited. On the premise of ensuring safety, the following actions must be taken after fording,

- Press the brake pedal gently to dry and check the brake for proper function.
- Turn the steering wheel to check the power steering system for proper function.

Check the functions of the following components:

- Horn
- Exterior lamp

Winter driving

In order for the vehicle to be safely driven in harsh cold conditions, it is recommended to perform the following:

- Make sure the power battery is in good condition and sufficiently charged. Cold weather places higher demand on the power battery and could cause the battery capacity to be reduced.
- Use winter rated windscreen washer fluid to prevent the washer system from malfunctioning due to ice forming.
- Install winter tyres with sufficient tread depth. The rubber compound of summer and all season tyres becomes hardened at lower temperatures, and the traction is reduced.
- Reduce speed, and avoid heavy braking and rapid acceleration on slippery roads.

In case of snow and ice built-up on the vehicle:

When snow and ice accumulate on the vehicle, remove the snow from the vehicle and remove the ice from the windscreen with a snow scrapper, and defrost the vehicle fully before driving to prevent the driver's vision from being adversely

affected. If any of the door handles is frozen in place, do not try to release it with tools or excessive force. It is recommended to deactivate the outside rearview mirror auto-fold function, as the folding and unfolding motion can be obstructed by snow and ice.

Recommended practices

Driving range

Many factors contribute to the driving range of the electric vehicle, and the circumstances and conditions under which the vehicle is driven effect the ability of achieving optimal driving range.

! NOTE

The remaining range on the driver information display is merely an estimate, and it may not account for factors such as driving styles and environmental conditions.

Factors effecting energy consumption include, but are not limited to:

- Speed: Higher speeds increase the energy consumption for the vehicle to overcome wind resistance.
- Trip conditions: the vehicle consumes some energy to maintain the temperature of the passenger cabin and power battery within an appropriate range, and short trips and heavy traffic increase the average energy consumption.
- Road conditions: When traveling uphill, the vehicle consumes more energy, and when traveling downhill, Energy Regenerative Braking allows the vehicle to regain a portion of its expended energy.
- Vehicle cargo load: Heavier gross vehicle weight increases the energy consumption to propel the vehicle.
- Wheels and tyres: The weight of the wheels and tyres, the design of the tyres, and the tyre pressure can all contribute to the vehicle rolling resistance.
- Using climate control: Heating or cooling the passenger compartment with the

climate control will consume energy from the high voltage battery.

- Added accessories: Installing accessories such as roof racks can reduce the aerodynamic efficiency and increase the energy consumption at higher speeds.
- External environment: External environment such as strong wind, extreme cold and extreme heat can increase the energy consumption of using the vehicle.

Hints to optimize the driving range

Before driving

- Plug in the vehicle to precondition the temperature of the passenger compartment and high voltage battery
- Check tyres for wear and maintain the correct tyre pressure.
- Lighten the vehicle by removing unnecessary cargo.

When driving

- Drive moderately and keep a good distance from others to minimize the need of braking.
- Limit the use of climate control. In cold weather, only use heated seats and heated steering wheel if possible, as heating the whole cabin consumes significantly more energy.
- Keep all windows up while in motion.

When parked

- Park the vehicle in a temperature modulated garage if possible.

The power meter on the driver information display indicates the current energy consumption and recovery level.

Preserving your high voltage battery

The efficiency and capacity of the high voltage battery degrade gradually as the high voltage battery ages due to its physical nature, and some circumstances could accelerate this process. In order to maintain the efficiency of the power battery and prolong its service life, the following practices are recommended:

Charging

- According to the travel needs, set a reasonable charging mode.

- Do not allow the high voltage battery to be fully discharged. If possible, keep the high voltage battery SOC above 20% at all times.
- When time allows, choose regular AC charging.

Long term parking

- The high voltage battery discharges slowly to power the onboard electronics even when the vehicle is not driven. Leave the vehicle plugged in when park for an extended period of time to prevent the high voltage battery from being fully discharged.
- Maintain the battery SOC between 50% and 80% when park for an extended period of time.
- Run the vehicle once every 4 weeks for a few minutes.
- Check the high voltage battery level or the charging connection periodically. If the battery level is low, charge immediately.

Temperature

- The best working temperature of the high voltage battery is within 10°C-30°C. If possible, it is recommended that the vehicle is parked in a place with suitable ambient temperature.
- The vehicle shall not be exposed to the environment with the temperature below -30°C or above 60°C for more than 24 hours.
- If the vehicle is placed in an environment with extreme outside temperatures for more than 24 hours, for example, below -30°C or above 60°C, the charging and discharging efficiency of the high voltage battery will be seriously affected. It is recommended that the vehicle is not exposed to the temperature below -30°C or above 60°C for more than 24 hours.

Starting the vehicle

⚠ WARNING Risk of injury if vehicle settings are adjusted while the vehicle is in motion

You could lose control of the vehicle particularly in the following situations:

- If you adjust the driver's seat, steering wheel, or mirrors while the vehicle is in motion.
- If you fasten your seat belt while the vehicle is in motion.
- ▶ Before starting the vehicle, adjust the driver seat, steering wheel and mirrors and wear the seat belt correctly.

1. After unlocking the vehicle and opening the driver's door, the windows and multimedia can be used normally.
2. Press the brake pedal, shift to drive **D** or reverse **R**, the indicator **READY** on the driver information display illuminates, and the vehicle can now run normally.

! NOTE Check driving conditions before starting the vehicle

- ▶ Check and confirm the brake pedal can be pressed to the bottom before starting the vehicle.
- ▶ Check whether the surrounding environment meets the conditions for starting the vehicle, if not, do not start the vehicle.
- ▶ Make sure the key is in the vehicle.

Vehicle emergency start

When the keyfob battery is low and the system cannot detect the key, a message will pop up on the centre display to remind you that the key is not detected. Start the vehicle as follows:

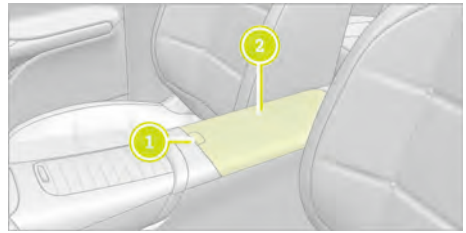

1. Press the button **1** of the armrest box to open the cover **2**.



2. Place the keyfob **3** in the front part of the armrest box.
3. Press the brake pedal, shift to drive **D** or reverse **R**, the indicator **READY** on the driver information display illuminates, and the vehicle can now run normally.

- ⓘ If you fail to start the vehicle after 3 attempts, wait 3 minutes and try again.
- ⓘ If you still fail to start the vehicle after 2 rounds, stop trying to avoid damaging your vehicle and contact a smart Authorized Service Partner.

Powering off the vehicle

1. Make sure the vehicle is stopped.
 2. Shift to park **P**.
 3. The driver exits the vehicle from the driver's door with the key.
 4. Lock the vehicle with the key and power off the vehicle.
- ⓘ Under some operation modes, the vehicle power cannot be switched off by the operations above. The operation mode needs to be turned off prior.

Alternatively, the vehicle can be powered off by tapping Power Off  on the centre display when the vehicle is in park **P**.

- ① The vehicle power will be switched off after tapping Power Off. If a re-start is needed, press the brake pedal.

Alcohol lock

Introduction of alcohol lock

The function of the alcohol lock is to prevent the car from being driven by individuals under the influence of alcohol. Before the car can be started, a breath test must be performed to ensure that the driver is not under the influence of alcohol.

- ① The Alcohol lock is an auxiliary device which does not exempt the driver from any responsibility. The driver should always be responsible for staying awake and driving safely.

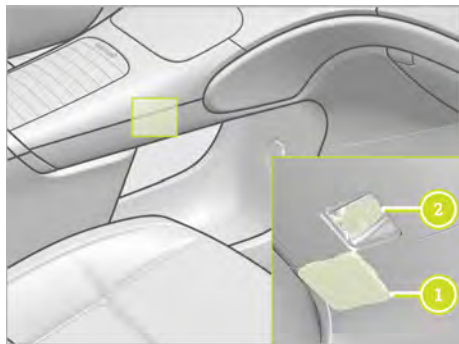

- ① Electrical connection interface cover
- ② Electrical connection interface

The vehicle is equipped with an electrical connection interface for the alcohol lock to facilitate the alcohol lock connection.

- ① For information about a specific alcohol lock, please read and follow the relevant alcohol lock manufacturer's instructions.

- ① The alcohol lock will work properly after an Authorized Service Partner performs the setup procedure. A smart Authorized Service Partner is recommended.

- ① smart provides alcohol lock installation document in smart service system, if you need to install, a smart Authorized Service Partner is recommended.

Energy Regenerative Braking

When the driver releases the accelerator pedal or presses the brake pedal, the vehicle can recover the mechanical energy to charge the high voltage battery.

Regeneration with accelerator pedal

Release the accelerator pedal, the vehicle brakes, and the energy flow recovery status is displayed on the driver information display.



Regeneration with brake pedal

Press the brake pedal, the vehicle brakes, and the energy flow recovery status is displayed on the driver information display.

Energy Regenerative Braking may be limited for the following reasons:

- The gear is in reverse **R**.
- Motor torque limit.
- The high voltage battery is fully charged.
- Speed limit, Energy Regenerative Braking is not available when the vehicle speed is lower than a certain value.

Adjust the energy regeneration level of Energy Regenerative Braking

- Tap  > *Energy Regenerative Braking* to adjust the energy regeneration level of Energy Regenerative Braking.
- Enter the setting interface:
Tap  > *Quick Controls* > *Energy Regenerative Braking* to adjust the energy regeneration level of Energy Regenerative Braking.

Functions of s-Pedal

▲ WARNING Possible risks caused by using s-Pedal

- ▶ It is a driver assistance system. It can never replace attention and judgment of the driver nor eliminate the need of pressing the brake pedal. The system will not automatically apply the brakes of the vehicle. Please press the brake pedal when necessary.
- ▶ You are always responsible for maintaining appropriate vehicle spacing and speed, and abiding by all applicable traffic laws and regulations.

With s-Pedal, it is possible to only use the accelerator pedal to accelerate and brake. Press the accelerator pedal for acceleration, release the accelerator pedal and put your foot thereon for slow deceleration, and take your foot off the accelerator pedal for a complete stop.

When driving with s-Pedal enabled, an indicator s-Pedal illuminates on the driver information display.

When s-Pedal is disabled and the accelerator pedal is not stepped on, the vehicle will travel at a speed of 7 km/h(5 mph). After s-Pedal is enabled, the vehicle will coast to stop and Autohold will be automatically activated.

Functions of s-Pedal

In case of any of the following circumstances, s-Pedal is not available:

- Gear position is in reverse **R**.
- Shifting to a wrong gear, such as shifting to park **P** or neutral **N** while driving.
- Pressing the brake pedal to decelerate.
- Driving on a sloppy hill.
- Using Hill Descent Control.
- Using the parking assist.
- Using the Cruise Control (if equipped)
- Using Adaptive Cruise Control.

- Using Highway Assist.
- Front Collision Mitigation is triggered.
- Automatic Parking Assist is activated.
- The drive mode is switched to the sport mode or BRABUS mode (if equipped).

Enabling/disabling s-Pedal

- Tap  > s-Pedal to enable/disable s-Pedal.

When s-Pedal is enabled, the brake light will illuminate when the accelerator pedal is released to decelerate.

When s-Pedal is enabled, Autohold is automatically activated when the accelerator pedal is released and the vehicle decelerates to a standstill.

Drive modes

Overview of the drive modes

You can select the drive mode (→ Page 98) on the centre display.

Depending on the drive mode selected, the following vehicle characteristics could change:

- Drive
- Steering

ECO mode

- An energy efficient and environmentally conscious driving experience. Driving in this mode saves more energy and is more efficient.

Comfort mode

- The standard mode for daily use. The comfort mode is on by default when the vehicle is started, and it provides the most comfortable driving experience.

Sport mode

- A mode with better dynamic experience and better sports characteristics. The acceleration response is faster, providing a high performance driving experience.

BRABUS mode (if equipped)

- The four wheel drive exclusive mode puts the vehicle in the best response and performance mode, and is

optimized for the highest performance, so that the vehicle gets better sportiness and dynamic response when accelerating.

Selecting a drive mode



1 Mode switch.

Tap the button 1 to select the following drive modes on the centre display:

- ECO mode
- Comfort mode
- Sport mode
- BRABUS mode (if equipped)

Launch Control (if equipped)

⚠ WARNING Accidents and risks caused by incorrect use of Launch Control

► Launch Control is only a personalized drive mode, and it is not suitable for all situations. You always bear the ultimate responsibility of maintaining the appropriate safety distance and vehicle speed and complying with all applicable road and traffic safety laws and regulations.

i Please be familiar with the operation of Launch Control in a closed section with good road conditions.

Please use the Launch Control carefully in the following situations (including but not limited to):

- When the vehicle is in this mode, the steering wheel is off-centre and the wheels are not in straight ahead positions.

- Driving on roads with accumulated water, mud, potholes, ice and snow, speed bumps and obstacles.
- Driving on sharp bends, slopes and narrow roads.
- Traffic conditions with many pedestrians, bicyclists, electric scooters or animals.
- Tunnel entrance and exit.

Enabling Launch Control

- The drive mode is set to Sport or BRABUS (if equipped).
- The vehicle is stationary.
- Fasten the seat belt properly.
- Set the shift lever to **D** position.
- Turning on the Launch Control switch:
 - Tap > to turn on the Launch Control.
 - Enter the setting interface: Tap > *Vehicle Settings* > *Driving* > *Launch Control* and turn on the Launch Control.
- Press the brake pedal and accelerator pedal at the same time.
- At this time, the driver information display prompts the user that the vehicle is in the Launch Control mode.
- Release the brake pedal according to the prompt on the driver information display and keep the accelerator pedal pressed to the bottom.
 - i When the Launch Control is activated, the ambient light shows the relevant dynamic effects according to the launch state, bringing an immersive driving experience.

Gear shift

Steering column gear selector

⚠ WARNING Risk of accident and injury due to children left unattended in the vehicle

If children are left unattended in the vehicle, they could in particular:

- Open doors, thereby endangering other persons or road users.
- Get out and be struck by oncoming traffic.
- Operate vehicle equipment and become trapped.

In addition, children could also set the vehicle in motion, by in particular:

- Releasing the parking brake
- Shifting the gear
- Starting the vehicle
- ▶ Never leave children unattended in the vehicle.
- ▶ When leaving the vehicle, always take the key with you and lock the vehicle.
- ▶ Keep the key out of the reach of children.

The driver information display indicates the current gear position when shifting gear.

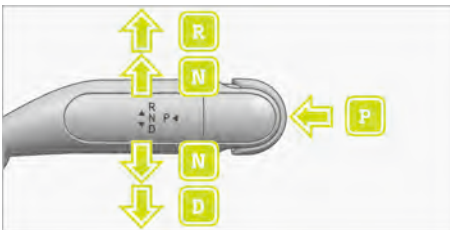

P Park

R Reverse

N Neutral

D Drive

Shifting to park **P**

Press the brake pedal and then press the button **P**, the driver information display indicates **P**.

Observe the notes on parking (→ Page 100).

The vehicle can be shifted to park **P if the following conditions are met:**

- When the vehicle is stopped and the gear is in drive **D**, reverse **R** or neutral **N**.
- If the vehicle is stationary and Autohold is not activated, the vehicle automatically shifts to park **P** when the driver unfastens the seat belt and opens the driver's door to exit.
- If the vehicle is stationary and Autohold is activated (Autohold indicator illuminated), the vehicle automatically shifts to park **P** when the driver unfastens the seat belt, the driver's door is opened, or Autohold has been activated for 10 min.

Shifting to reverse **R**

Press the brake pedal and push the gear selector lever upward past the first resistance point, the driver information display indicates **R**.

The vehicle can be shifted to reverse **R if the following conditions are met:**

- When the vehicle is stopped or the gear is in **D** or **P**.

Shifting to neutral **N**

Press the brake pedal and push the gear selector lever upward or downward to the first resistance point and hold until the driver information display **N**, release the brake pedal, and now the vehicle can be moved freely.

! NOTE Damage to the vehicle if it rolls away

- ▶ Always properly secure the vehicle against rolling away.

Shifting to drive **D**

Press the brake pedal and push the gear selector lever downward past the first resistance point. The driver information display indicates **D**.

Parking**Parking the vehicle**

⚠ WARNING Risk of accident and injury due to the vehicle rolling away

If the vehicle is not properly parked, it may roll away in an uncontrollable manner even on a small downhill slope.

The vehicle shall be properly parked and secured in accordance with the following methods to prevent rolling away:

- ▶ In uphill or downhill sections, turn the front wheels toward the kerb so the vehicle moves toward the kerb in case of rolling away.
- ▶ Shift the vehicle to park **P**. The electric parking brake is applied automatically.

⚠ WARNING Risk of accident and injury due to children left unattended in the vehicle

If children are left unattended in the vehicle, they could in particular:

- Open doors, thereby endangering other persons or road users.
- Get out and be struck by oncoming traffic.
- Operate vehicle equipment and become trapped.

In addition, children could also set the vehicle in motion, by in particular:

- Releasing the parking brake
- Shifting the gear
- Starting the vehicle
- ▶ Never leave children unattended in the vehicle.
- ▶ When leaving the vehicle, always take the key with you and lock the vehicle.
- ▶ Keep the key out of the reach of children.

📌 NOTE Damage to the vehicle if it rolls away

- ▶ Always properly secure the vehicle against rolling away.

Parking the vehicle

1. Depress the brake pedal so that the vehicle remains stationary.
2. In uphill or downhill sections, turn the front wheels toward the kerb so the vehicle moves toward the kerb in case of rolling away.
3. After pressing the brake pedal, shift to park **P** when the vehicle is stationary, and the electric parking brake is applied automatically.
4. Release the brake pedal slowly.
5. Exit the vehicle and lock it.

Electric parking brake

Automatic application of the electric parking brake

The electric parking brake applies if the vehicle is in park **P**.

The electric parking brake also applies in case of the following conditions:

- The parking system keeps the vehicle in the stationary state.



If the electric parking brake is applied, the red indicator  on the driver information display illuminates.

Releasing the electric parking brake

When the brake pedal is pressed, the electric parking brake is automatically released when switching from park **P** to drive **D**, neutral **N**, or reverse **R**.

If the electric parking brake is released, the red indicator  on the driver information display goes out.

Applying/releasing the electric parking brake on the centre display

- Tap  >  to apply/release the electric parking brake.

Parking assist

Parking assist can help you when you drive in/out parking spaces, parking lots and other places.

Parking assist camera and radar locations

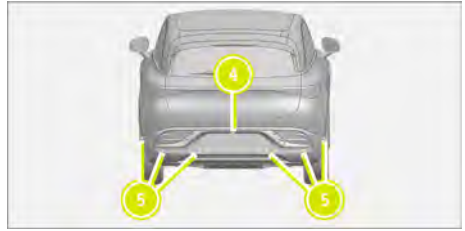
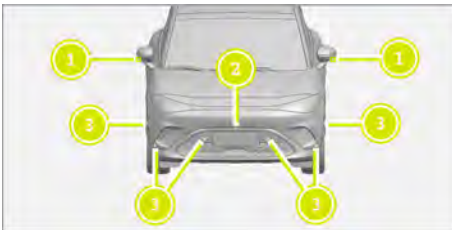

- 1 panoramic cameras, located on the outside rearview mirrors.
- 1 panoramic camera, located above the front license plate frame.
- 6 front radars, located on the front bumper.
- 1 panoramic camera, located above the rear license plate frame.
- 6 rear radars, located on the rear bumper.

- ⓘ Depending on the model configuration and market, the actual equipment of your vehicle may be different from the descriptions and illustrations. Refer to the actual vehicle.

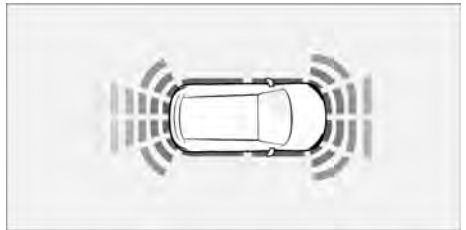

The system uses distance indicator/fan area to indicate objects detected.

Underlined fan area means that there is an object detected in the area. As the vehicle gets closer to the object, the highlighted sector changes from green to yellow, and then to red. Depending on which side the object is detected on, the fan-shaped area on that side changes colour independently. You will also hear an alarm. The closer the vehicle is to the object, the higher the alarm frequency.

Distance indicator in the camera view picture also changes color accordingly.

Limitation of the parking assist

Parking assist has certain limitations.

- If the radars and cameras are blocked, by dust, snow, and ice for example, this may cause the parking assist to issue a false warning.
- If the license plate is installed beyond the license plate holder, it may cause the parking assist to issue a false warning.
- If the vehicle is on a steep hill, the radars may issue a false warning.
- The radars may be unable to detect objects made of special materials or personnel wearing clothes made of special materials.
- Obstacles that cannot be recognized by the radars, such as low obstacles, wave-absorbing objects, and reflective objects, may cause false warning and omissions of obstacles.
- The radars cannot or do not detect flat objects on the ground, objects under the bumper, objects that are too close or too far from the vehicle.
- Do not use mud flaps, bumper bars and other accessories not produced by the original manufacturer, otherwise the radars could fail.
- Bad weather conditions, such as rain, snow, and bright light, could affect the detection of the parking assist cameras.
- Due to the installed positions of the radars, obstacles outside the wheel trajectory may be detected when the vehicle is not driving along a straight line.
- Some scenarios could affect the detection ability of the radars. These may include roads with fences, driving in a tunnel, driving in/out of vehicles ahead, and sharp corners.

⚠ WARNING Accident risks caused by use of the parking assist

Parking Assist only provides assistance, and it may not operate normally under some driving conditions, weather conditions, traffic conditions or road conditions. You are always responsible for maintaining appropriate vehicle spacing and speed, and abiding by all applicable traffic laws and regulations.

- ▶ Pay attention to the surroundings of the vehicle when parking, and confirm the parking conditions before parking.
- ▶ The system cannot detect obstacles in the blind spots of the sensors.
- ▶ The radars may not work in places with strong electromagnetic radiation.
- ▶ When the vehicle is impacted, the system performance will be degraded. In severe cases, the system will have a fault prompt. Contact a smart Authorized Service Partner immediately.
- ▶ When there is a malfunctioning notification about the parking assist system, low speed emergency braking function, parking system or its associated systems, have the vehicle inspected and repaired at a smart Authorized Service Partner.

Front parking assist

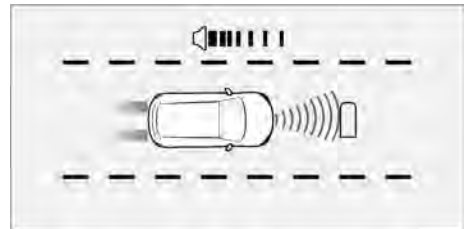

The front radars are enabled automatically when the speed is below about 15 km/h (10 mph) after starting the vehicle. The farthest distance monitored in front of the vehicle is about 1.0m.

Rear parking assist

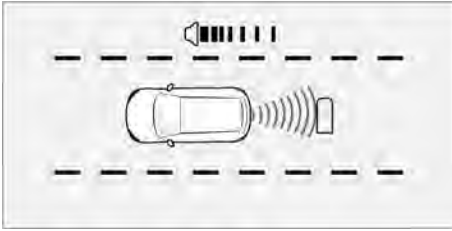

After the vehicle is started, the rear radars are automatically activated when the vehicle is shifted to reverse **R** and the vehicle speed is below 15 km/h (10 mph). The sound warning signal will be enabled if the vehicle is about 1.5 meters from the rear object.

- ⓘ The parking assist system is not available in trailer mode.

Automatic Parking Assist (APA)

Overview of Automatic Parking Assist (APA)

⚠ WARNING Accident risks caused by use of the Auto Parking Assist

- ▶ Even if the auto parking assist is enabled, it is always your responsibility for intervention by holding the steering wheel or depressing the brake pedal when necessary.
- ▶ As a driver, you should abide by local laws and regulations, and always take full responsibility for safe parking.

Automatic Parking Assist can automatically search for parking spaces on both sides of the vehicle and prompt the driver to stop when an available parking space is found. After the vehicle is stopped, operate according to the system prompts. Automatic Parking Assist calculates the parking trajectory and controls the vehicle's steering, speed, gear, etc. to slowly drive the vehicle into the selected parking space.

Automatic Parking Assist supports 3 kinds of parking spaces: inclined parking spaces,

vertical parking spaces, and parallel parking spaces (cubic parking space excluded).



Limitations of Automatic Parking Assist

If any of the following circumstances occurs, Automatic Parking Assist will stop and is forced to exit. You must take over the vehicle at this moment.

- Objects around the vehicle that can be identified during parking:
 - Cylindrical objects with diameter larger than 75 cm and height of 1 m.
 - Walls larger than 40 cm x 40 cm x 100 cm.
 - Low obstacles larger than 25 cm x 25 cm x 25 cm.
 - Square wall pillars with side length larger than 30 cm and height of 1 m.
 - Road kerbs/steps with height of 20 cm, length of 1.2 m, and angle between 80° and 90°.
 - Wire meshes with size of 1 m x 1 m, hole diameter of 3 cm, and wire diameter of 3 mm.
- When the following scenes are around the vehicle or the parking space, be cautious about using the parking assist function. When using the parking assist function, pay attention to the vehicle surroundings and be ready to take over the vehicle at any time.
 - Suspended fire pipes, fire hydrants, stone piers, limit piles and barriers, fences, flower beds, lamp posts, kerbs and steps, shopping carts, pillars etc.
 - Narrow parking spaces, underground parking lots with unclear parking lines, irregular parking spaces, parking spaces with no parking sign, parking spaces on a slope, parking space with an engaged floor lock, pitted parking spaces, parking spaces near a kerb or step higher than the

vehicle chassis, and parking spaces near a gully or ditch.



- The parking space is too small.
- The parking process is overspeed or overtime.
- Using tyre chains.
- Tow bar activated/trailer activated.
- Gear intervention.
- Steering wheel intervention.
- Accelerator pedal intervention.
- Camera failure/radar failure.
- The slope exceeds 8%.
- The rain is too heavy.
- Excessive number of repeated reversing.
- Be not recovered from interruption.

For more information on the limitations of Automatic Parking Assist, refer to the overview of the parking assist system (→ Page 101).

- ① ▶ When Automatic Parking Assist is used to park the vehicle at a parking space close to the road edge, the traveling trajectory set by the function may exceed road edge. Shift the gear according to actual conditions so as to prevent tyre or wheel damage caused by raised road shoulders.
- ▶ Tyres not produced by the original manufacturer or wrong tyre pressure may affect the performance of Automatic Parking Assist.

Parking in a parking space

Enter the Automatic Parking Assist interface:

- When the vehicle speed is less than 30 km/h(20 mph), tap  to enter the application interface, tap  to enter the Automatic Parking Assist interface, or press the button  on the left of the steering wheel to enter the Automatic Parking Assist interface.

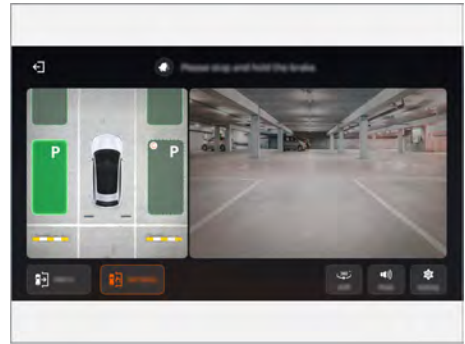

1. When the vehicle speed is below 25 km/h(16 mph), the vehicle searches for available parking spaces automatically. If the vehicle speed exceeds the limit, the system prompts to slow down and stop searching. The vehicle speed needs to be reduced below 22 km/h(14 mph), so the search for parking spaces can be resumed. If the vehicle speed exceeds 30 km/h(20 mph), the Automatic Parking Assist interface exits automatically.



2. After finding an available parking space, the centre display prompts to park and other relevant information, and displays the searched parking space.

When multiple parking spaces are found, the system will recommend the optimal parking space after the vehicle stops. You can also choose the preferred parking space.

3. After the vehicle is stopped, press Start.
4. Release the steering wheel and brake pedal to start parking automatically.
5. After the automatic parking is finished, the system prompts that the parking is completed.

Automatic Parking Assist Setting

Enter the Automatic Parking Assist Setting interface:

- Swipe leftward on the centre display or tap  to enter the application interface, tap  to enter the Automatic Parking Assist interface, tap  to enter the Automatic Parking Assist Setting interface, and turn on/off language interaction/automatic activation.

Parking Emergency Brake (PEB) (if equipped)

Parking Emergency Brake detects pedestrians or stationary objects behind the vehicle through radars on the rear bumper and parking assistance cameras. When there is a risk of collision, Parking Emergency Brake initiates emergency braking to the vehicle and issues visual and audio prompts.

- ① Depending on the model configuration and market, the actual equipment of your vehicle may be different from the descriptions and illustrations. Refer to the actual vehicle.

Limitation of Parking Emergency Brake

Parking Emergency Brake cannot be used normally under the following circumstances:

- The reversing speed of the vehicle exceeds 12 km/h(8 mph).
- Rapid moving pedestrians.
- Weak light.
- Rainstorm for over 10 seconds continuously.
- When the radars and parking assist camera are dirty or in case of system failure.
- On slippery roads, the collision avoidance performance of Parking Emergency Brake will be reduced, because the vehicle needs a longer braking distance.

For more information on the limitations of parking assist system, refer to (→ Page 101).

⚠ WARNING Accidents and risks caused by inappropriate use of emergency parking brake

- ▶ Any automatic system cannot guarantee normal operation under any circumstance. Never drive toward personnel or object for the purpose of testing emergency parking brake. Accidents may be caused, which may result in personal injury or death.

- ① Parking Emergency Brake may conduct unnecessary braking under complicated driving conditions. For example, construction sites, rails, road manhole covers, underground parking lots, water sprinkled or splashed ahead the vehicle.

! NOTE Notes on Parking Emergency Brake

- ▶ When Parking Emergency Brake is activated, you can deactivate Parking Emergency Brake by pressing the brake pedal or accelerator pedal.
- ▶ If there is no other operations within 30 seconds upon the activation of Parking Emergency Brake, the system will enable the electronic parking brake automatically.
- ▶ After enabling/disabling Parking Emergency Brake, the centre display indicates the corresponding information.

Enabling/disabling Parking Emergency Brake

Enter the Settings interface:

- Tap  > *Driving Assistance* > *Safety* > *Parking Emergency Braking* to enable/disable the Parking Emergency Brake.

Driver assistance and driving safety system

Driver assistance systems and your responsibilities

Your vehicle is equipped with driver assistance systems that help you drive, park, and steer the vehicle. The systems are only an aid and cannot cope with all traffic, weather, or road conditions. You are always responsible for maintaining appropriate vehicle spacing and speed, and abiding by all applicable traffic laws and regulations.

Make sure that the driver reads all the topics related to the driver assistance systems in the complete User Manual to understand the factors such as the

function limitations of the driver assistance systems and understand the knowledge the driver should have before using the system.

Driver assistance system sensors

The vehicle is equipped with multiple radars and cameras, which are used to detect the distance between the vehicle ahead and your vehicle, identify traffic or road signs, and detect surrounding vehicles, pedestrians, etc.

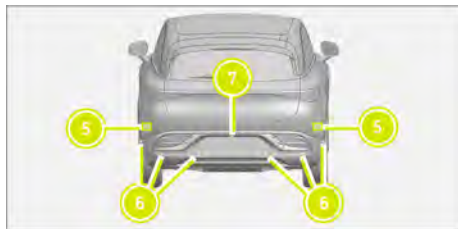
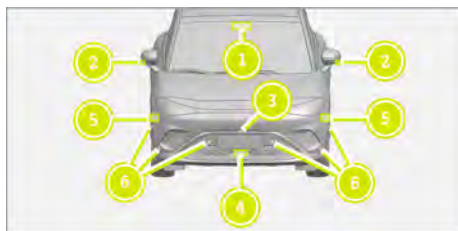

- 1 Forward camera, located behind the inside rearview mirror.
- 2 2 panoramic cameras, located on the outside rearview mirrors.
- 3 1 panoramic camera, located above the front license plate frame.
- 4 Forward millimeter wave radar, located in the centre of the front bumper.
- 5 Corner radars, located on both sides of the front and rear bumpers.
- 6 12 front and rear radars, located on the front and rear bumpers.
- 7 1 panoramic camera, located above the rear license plate frame.

- ⓘ Depending on the model configuration and market, the actual equipment of your vehicle may be different from the descriptions and illustrations. Refer to the actual vehicle.

Limitations of driver assistance system sensor

The sensor of the driver assistance system has certain limitations. In daily car use, please pay attention particularly to the following conditions, otherwise the driver assistance system may not work properly:

- Never install accessories such as license plate decoration frame, or decals in the radar, camera and surrounding areas. Otherwise, the working range of the sensors may be affected, thus causing some drive assistance systems to fail to work.
- Severe weather conditions, such as heavy snow, heavy rain, and fog, may weaken the sensors or cause the system to temporarily stop working.
- Strong lighting, reflective surfaces, ice or snow, water, dirt on road or blurred lane marker lines may significantly affect the camera's ability to recognise vehicles, pedestrians, traffic signs, or other obstacles.
- The radar can be interfered with by other radio devices or strong radar reflections.
- In some cases, the radar may take longer than expected to detect other vehicles or completely fail to detect them.
- When a vehicle is driving on the winding, narrow and steep roads or entering or exiting a tunnel, the radar may fail to detect forward vehicles or other obstacles.
- Never slam into the sensor or the surrounding area.
- The cracks/scratches or stone chips in the bumper area behind the radar affects the radar function.
- If the passenger cabin has very high temperature, the forward camera may be temporarily disabled for a while. Until

being cooled to a low enough temperature, the forward camera cannot automatically restart or resume working.

- To make sure the radar work normally, the radar area must be free from dust, ice, snow, or other dirt, and the area must be cleaned regularly.

Anti-lock Brake System (ABS)

The vehicle is equipped with ABS to prevent the wheels from locking when you apply the maximum braking force. Under most road conditions, this function can improve the steering control performance of the vehicle in case of emergency braking.

NOTE Notes on Anti-lock Brake System

If the Anti-lock Brake System fault and brake system state indicators are continuously on, drive off the road as quickly as possible, park safely and contact a smart Authorized Service Partner. If the brake is applied in such situation, Anti-lock Brake System will be ineffective, and the vehicle will become very unstable.

- ① Excessive high tyre pressure, excess low tyre pressure or using tyres of different sizes may result in losing brake efficiency.

As long as the brake pedal is firmly pressed, Anti-lock Brake System is enabled automatically. You may also hear working sound of the ABS motor and feel pulsation of the brake pedal. It is normal.

Electronic Brake Distribution (EBD)

EBD can adjust the distribution ratio of braking force of front and rear axles automatically during braking to improve brake performance, and work with ABS to improve brake stability, so as to make sure steady driving of the vehicle.

Brake assist

▲ WARNING Risk of accident due to brake assist failure

If brake assist fails, the braking distance under emergency brake will increase.

- ▶ For emergency brake, fully press the brake pedal. Anti-lock Brake System can prevent the wheels from locking up.

Brake assist provides support in hard braking situations with additional braking force.

Press the brake pedal quickly and the brake assist is enabled:

- Brake assist increases the brake pressure automatically.
- Brake assist can shorten the braking distance.
- Anti-lock Brake System can prevent the wheels from locking up.

Once the brake pedal is released, the brake will operate normally and brake assist will be disabled.

Post Impact Braking (PIB)

After a vehicle collision, Post Impact Braking initiates an automatic braking intervention to decelerate the vehicle, so that the subsequent collisions can be avoided or the impact severity can be mitigated.

During the Post Impact Braking operation, an extra noise may be heard inside the passenger compartment. The noise, which is caused by the hydraulic pump and control valves, is transmitted to the passenger compartment through the vehicle body.

When Post Impact Braking is operating, the hazard warning lights flash.

Post Impact Braking is enabled by default once the vehicle ignition is on, and you are unable to disable it.

When Anti-lock Brake System is damaged during the collision, Post Impact Braking will not be triggered.

Electronic Stability Control

The electronic stability control system can help the driver prevent the vehicle from slipping, and improve vehicle traction

When the system is functioning, the indicator  flashes on the driver information display. You may hear a pulse sound generated during system braking. The vehicle acceleration may be slower than expected when the accelerator pedal is pressed.

When the indicator  is on continuously on the driver information display, the electronic stability control system is malfunctioning. Contact a smart Authorized Service Partner for repair.

The system consists of the following functions:

- Vehicle dynamic control
- Traction control
- Anti rollover protection

Notes on the electronic stability control system:

- The function is a driver assist function aimed to improve driving convenience and safety. It cannot cope with all traffic and weather conditions.
- The system cannot replace the attention and judgment of the driver. The driver shall drive the vehicle safely at an appropriate speed, maintain a reasonable distance from other vehicles, and follow local laws and regulations.

Vehicle dynamic control

The function checks the driving and braking force of each wheel to stabilize the vehicle.

Traction control

The function is activated at low speed and brakes the spinning drive wheel, so as to transfer power to the drive wheel with traction.

The function can also prevent the slipping or spinning of drive wheels on the pavement during acceleration.

Anti rollover protection

The function can reduce the risk of rollover due to sudden evading or vehicle slipping. If the vehicle is in a dangerous state, the electronic stability control system reduces the torque output and applies the brake to one or more wheels until the stability is recovered.

Electronic Stability Control Sport Mode

Overview of Electronic Stability Control Sport Mode



The driver can select Electronic Stability Control Sport Mode to acquire much more active driving experience.

If Electronic Stability Control Sport Mode is selected, system intervention will be reduced, allowing increased vehicle slipping.

When Electronic Stability Control Sport Mode is selected, the assistance provided by Electronic Stability Control for the driver is limited.

If the vehicle is trapped and cannot move out or when the vehicle is driving on a soft surface, such as sand or snow, Electronic Stability Control Sport Mode can provide greater traction.

Enabling/disabling Electronic Stability Control Sport Mode

- Tap  >  to enable/disable Electronic Stability Control Sport Mode.
- Enter the setting interface:
Tap  > *Vehicle Settings* > *Driving* > *ESC Off* to enable/disable the Electronic Stability Control in the Sport mode.

In the driver information display, the indicator  is always on, which indicates this system is turned off. The system restores normal mode after the vehicle is started next time.

Park Assist 360 Camera

The Park Assist 360 Camera captures the situation around the vehicle through the parking assist cameras and displays the images on the centre display, providing you with a panoramic view of the vehicle.

⚠ WARNING Accident risk due to improper use of Park Assist 360 Camera

- ▶ People, objects, obstacles displayed on the centre display may seem closer to the vehicle than they actually are.
- ▶ The parking assist cameras are designed to assist in parking. However, Park Assist 360 Camera cannot substitute your attention and judgment.
- ▶ There are blind spots for cameras. Within the blind spots, cameras cannot detect objects or people around or near the vehicle.

i When the vehicle is shifted to reverse **R**, Park Assist 360 Camera is enabled automatically. After switching to park **P**, if there is no view switching operation in 5 seconds, Park Assist 360 Camera will exit. Park Assist 360 Camera can only be enabled when the vehicle speed is less than 30 km/h(19 mph).

Limitations of Park Assist 360 Camera



- The Park Assist 360 Camera can support videos and images with multiple views.
- Imaging is affected by the environment, and may not present real color effects, for example, illumination influence/ chromatic aberration.
- Due to the limitation of the sensor's own characteristics, the imaging effects may be subject to certain deformation/ error, etc.
- Because of visual factors and image deformation factors, images can not be used as the basis for judging the distance.
- Under the condition of insufficient or excessive illumination, the imaging quality will decline to some extent.
- The Park Assist 360 Camera only provides visual images. The driver needs to always pay attention to the actual road environment.

- Keep the lens clean before use, so as not to affect the final imaging effects.
- Before proper use, the Park Assist 360 Camera shall be calibrated.

For more limitations of the parking assist cameras, refer to Overview of Parking Assist System (→ Page 101).

Turning on Park Assist 360 Camera

Enter the Park Assist 360 Camera interface:

- Swipe leftward on the centre display or tap  to enter the application interface, and tap the Park Assist 360 Camera or the status bar  to enter the Park Assist 360 Camera interface.

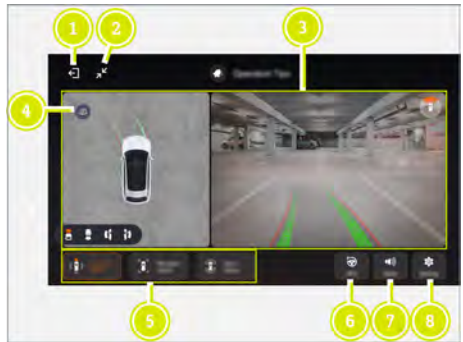

- 1 Turn off the Park Assist 360 Camera.
- 2 Zoom out the display, and exit the full screen display.
- 3 Park Assist 360 Camera view.
- 4 Select the 2D or 3D view.
- 5 You can tap the corresponding view icon to have the desired view: front wide-angle view, side views and rear wide-angle view.
- 6 Enter the Automatic Parking Assist (if equipped).
- 7 Enable/disable sound.
 - i** When the function is automatically enabled, you can choose to turn on/off the sound.
- 8 Set up the Park Assist 360 Camera:
 - Turn on/off the blind spot steering link.
 - Turn on/off the front collision warning.
 - Turn on/off the transparent car view.

Turn on/off the parking distance control.

- ① When the vehicle is shifted into **R** gear, the setting button, exit button and minimize button in the Park Assist 360 Camera interface are unavailable.
- ② You can drag the Park Assist 360 Camera mini window to the desired position, and the current position can be memorized. When the Park Assist 360 Camera is used next time, the mini window will display at the last memorized position.

Power assisted steering

Steering Wheel Re-centering

When the driver enters the vehicle and the system detects the steering wheel is not centred, the system will notify the driver.

Enter the setting interface:

- Tap  > *Vehicle Settings* > *Driving* > *Steering Wheel Re-Centering* to enable/disable Steering Wheel Re-Centering.

Steering Assist

The Steering Assist reduces the force required to turn the steering wheel for better control of the vehicle, and provides different power assistance force according to the selected drive mode.

Enter the setting interface:

- Tap  > *Quick Controls* > *Steering Assist* to adjust the Steering Assist to the Auto, Soft, Comfortable or Steady mode.



Autohold

WARNING

Autohold is only a driving assistance function and it does not replace the electric parking brake to apply brake. You must always maintain control of the vehicle and bear all responsibilities for the safety of the vehicle.

Autohold provides braking for brief stops during normal driving, so you don't need to keep pressing the brake pedal. When Autohold is activated, pressing the accelerator pedal or pressing the brake pedal again can deactivate Autohold.

Enabling/disabling Autohold

- Tap  >  to enable/disable Autohold.

When Autohold is activated, the driver information display displays the green indicator lamp  .

- ① When the vehicle is shifted to reverse **R** , Autohold is not functional.

Autohold is automatically switched to electric parking brake when:

- The driver releases the seat belt or opens the driver's door.
- The Autohold time is exceeded (approximately 10 minutes).
- Shifting to park **P** .

- ② Press the brake pedal deeply to activate this function, and press the brake pedal deeply again to deactivate this function.

Disable Autohold when using an automatic car washer.

Cornering Brake Control

NOTE

Cornering Brake Control is only an assistance system, and the driver must always maintain control of the vehicle and take full responsibility for the safe driving of the vehicle.

Cornering Brake Control can control the braking pressure on the inner wheels when the vehicle is braking in a turn to prevent the inner wheels from locking up too early and improve the driving stability of the vehicle.

Hill Assist

Hill Assist can help you start on the hill and prevent the vehicle from slipping backward. After releasing the brake pedal, Hill

Assist can keep the vehicle stopped on the hill for about 2 seconds.

Hill Assist works even when Automatic Parking Assist is disabled.

NOTE Notes on Hill Assist

Hill Assist cannot replace the parking brake. Shift to park **P** when you leave the vehicle.

Press the brake pedal immediately when the vehicle slips backward. Hill Assist cannot completely prevent the vehicle from slipping backward from a steep hill under full load or on all road conditions.



Hill Descent Control (HDC)

Hill Descent Control can control the speed through automatic braking intervention. This function is especially useful when going down a steep slope, especially when the terrain is rough, slippery and pockmarked.

At the same time, you can also press the accelerator pedal to temporarily increase the downhill speed, or press the brake pedal to slow down or stop at any time.

- ⓘ Hill Descent Control is an aid, which cannot handle all situations or road conditions. The driver is always responsible for driving the vehicle safely.

Enabling/disabling Hill Descent Control

- Tap  >  to enable/disable Hill Descent Control.

When Hill Descent Control is in the ready mode or when the vehicle speed is below 60 km/h (38 mph), the grey/white indicator

 on the driver information display illuminates.

When Hill Descent Control is activated, the green indicator  on the driver information display illuminates.

- ⓘ This function can only be enabled when the vehicle runs downhill at low speed on a steep slope.

When the vehicle speed is higher than 60 km/h (38 mph), the system automatically disables the function.

After the Hill Descent Control is disabled, the braking force will gradually decrease until it disappears.

Low speed warning

When the vehicle is in **D** or **R** gear and the vehicle speed is less than 23 km/h (15 mph), a low speed alarm tone will occur to remind pedestrians to pay attention to the approach of the vehicle.

- ⓘ For the driver, the low speed warning is an assistant function, which cannot replace the driver's judgment to traffic conditions. You are always responsible for driving the vehicle safely.

Observe the following precautions for the low-speed alarm function:

- When the vehicle moves forward or backward at a speed lower than 23 km/h (15 mph), the low speed warning alerts pedestrians. This helps other road users (particularly pedestrians and cyclists) to hear your vehicle better.
- When the vehicle moves at a speed over 23 km/h (15 mph), the low speed warning is switched off.
- Despite the low speed warning, in some cases pedestrians or other vehicles may not be able to hear your vehicle moving, and it is always your responsibility to drive your vehicle safely.
- The low speed warning is turned off when the vehicle is stationary.



Speed Limiting (LIM)

When the driver adjusts the speed using the accelerator pedal, Speed Limiting can prevent the vehicle speed from accidentally exceeding the preset maximum value for a short time. If the accelerator pedal is pressed for a long time, the vehicle speed will exceed the preset maximum value.



Notes on using Speed Limiting:



- The function is a driver assistance support, which makes driving easier and safer, but it cannot handle all traffic, weather and road conditions.
- This system is not a substitute for driver's attention and judgment. The driver shall drive the vehicle safely at an appropriate speed, maintain a reasonable distance from other vehicles, and follow local laws and regulations.

Enabling Speed Limiting

Press the button   on the left of the steering wheel and select smart Pilot Assist/Adaptive Cruise Control/Cruise Control (if equipped)/Speed Limiting according to vehicle configuration. Press the button  on the left of the steering wheel to activate and enable the selected function. Speed Limiting shall be enabled to adjust speed.

You can set the Speed Limiting when your vehicle is at **D** gear. Configurable minimum speed is 30km/h(20 mph).

Press the button   on the left of the steering wheel to turn on the Speed Limiting. When the indicator light  on the driver information display turns gray, the Speed Limiting is in Ready mode.

When the Speed Limiting is selected, press the button  on the left of the steering wheel to enable it. When the indicator light  on the driver information display turns green, the Speed Limiting is enabled, and the current vehicle speed is stored as the maximum speed.

Press the button  on the left of the steering wheel: a short press increases the speed by 1 km/h (1 mph), and a long press increases it by 5 km/h (3 mph).

Press the button  on the left of the steering wheel: a short press decreases the speed by 1 km/h (1 mph), and a long press decreases it by 5 km/h (3 mph).

Disabling Speed Limiting

Press the button  on the left of the steering wheel. When the indicator light

 on the driver information display turns gray, the Speed Limiting is in the Ready mode.

Cruise Control (if equipped)

▲ WARNING Possible risks due to using Cruise Control

- ▶ Cruise Control only provides assistance, and it may not operate normally under some driving conditions, weather conditions, traffic conditions and road conditions, etc. You are always responsible for maintaining appropriate vehicle spacing and speed, and abiding by all applicable traffic laws and regulations.

Cruise control helps the driver maintain a steady speed, making it easier to drive on highways and long straights with normal traffic.

Cruise control can keep the speed between 20 – 150 km/h(13 – 94 mph) without constantly pressing the accelerator pedal.

Limitations of Cruise Control



When the vehicle goes uphill, Cruise Control may not be able to maintain the set speed. When you return to the flat road, the vehicle speed will resume.



When driving on a long and steep downhill slope, make the displayed speed equal to the set cruising speed.

Never use Cruise Control particularly in the following situations:

- You are driving on winding roads or in heavy traffic.
- You are driving on slippery roads or with poor visibility.

Setting Cruise Control to Ready mode



Press the button   on the left of the steering wheel and select smart Pilot Assist/Adaptive Cruise Control/Cruise Control/Speed Limiting according to vehicle configuration. Press the button  on the left of the steering wheel to activate and enable the selected function.

When the button   on the left of the steering wheel is set to Cruise Control and the grey/white indicator  on the driver information display comes on, Cruise Control is in the ready mode.

Activating Cruise Control

Operation conditions of Cruise Control:



- The drive system is working.
- The gear position is in drive .
- Electronic Stability Control is enabled.
- The electric parking brake is released.
- The brake pedal is not pressed.
- The driver must be at correct driving state and speed shall be greater than 20 km/h (13 mph).

When the button  on the left of the steering wheel is pressed and the green indicator  on the driver information display illuminates, the current vehicle speed is set as the cruise speed.

Press the button  on the left of the steering wheel: a short press increases the speed by 1 km/h (1 mph), and a long press increases it by 5 km/h (3 mph).

Press the button  on the left of the steering wheel: a short press decreases the speed by 1 km/h (1 mph), and a long press decreases it by 5 km/h (3 mph).

Deactivating Cruise Control

Press the button  on the left of the steering wheel. After the Cruise Control enters the Ready mode, the indicator light  on the driver information display turns gray, indicating that the function enters the Ready mode, and the Cruise Control does not control the vehicle speed.

In case of any of the following circumstances, cruise control will be disabled and set to Ready mode.

- Press the brake pedal.
- Move the selector lever to  position.
- The driver keeps the vehicle speed higher than the set speed for more than 1 minute.

After the Cruise Control enters the Ready mode, the vehicle speed will not be automatically adjusted.



The driver can press the accelerator pedal to temporarily increase the vehicle speed, for example, when overtaking, which will not change the working state of the Cruise Control. When the accelerator pedal is released, the vehicle will return to the last stored cruising speed.

The Cruise Control will automatically enter the Ready mode for any of the following reasons:

- The wheels have lost traction.
- Brake temperature is too high.
- The speed drops below 20 km/h (13 mph).

- ⓘ After entering into standby mode, Cruise Control no longer controls the vehicle speed. The driver must control the vehicle speed.

Re-activating Cruise Control

Press the button  on the left of the steering wheel, so the Cruise Control will resume the last set cruising speed. At the same time, a green indicator light  on the driver information display comes on.

If the driver presses the accelerator pedal on the long downhill slope and current speed displayed exceeds the set cruising speed, the Cruise Control remains active.

Adaptive Cruise Control (ACC) (if equipped)

Adaptive Cruise Control can control the speed in the range of 0 - 150 km/h (0 - 90 mph) based on the target speed and the car-following distance interval.

You can set your desired speed or vehicle following distance interval. When the system detects that the speed of the vehicle ahead is lower than the set speed, the vehicle automatically slows down to make sure a proper distance to the vehicle ahead is maintained. If the vehicle ahead accelerates and its speed is over the set speed, or you change lanes and no slow vehicle is in front of you, the system

automatically controls the vehicle to bring the speed to the set speed.

Limitations of Adaptive Cruise Control:

Always remember that in some special road conditions, such as viaducts, bridge tunnels or tunnels, Adaptive Cruise Control may not be activated or may exit automatically due to system limitations. Adaptive Cruise Control is mostly suitable for driving on smooth roads. If you enable this function on steep downhill sections or when driving with heavy loads, it may be difficult to maintain the correct distance to the vehicle ahead. In this case, pay special attention and prepare for braking at any time.

▲ WARNING Risk of accident from driving with Adaptive Cruise Control

Adaptive Cruise Control is only a driver assistance system. It cannot completely replace the driver for safe driving. When using Adaptive Cruise Control, the driver still needs to control the vehicle according to the actual road conditions or traffic conditions.

- ▶ Adaptive Cruise Control is an assistance function for the driver. It can not replace the driver for driving. You are always responsible for driving the vehicle safely and observing local laws and regulations.
- ▶ Adaptive Cruise Control can smoothly adjust the vehicle speed to respond to the driver's intentions and traffic conditions ahead. As sensor functions are limited, the system may brake unnecessarily or not brake when necessary. In case of immediate braking, it is your responsibility to actively take braking measures.
- ▶ Adaptive Cruise Control cannot cover all driving scenarios and traffic, weather and road conditions.
- ▶ If the Adaptive Cruise Control fails to maintain a proper vehicle speed or a proper distance from the vehicle ahead, you must intervene.
- ▶ Repair or replacement of the Adaptive Cruise Control and its components requires professional equipment and technicians. Please contact a smart Authorized Service Partner for relevant operations.
- ▶ The Adaptive Cruise Control may not respond to animals, pedestrians, irregular vehicles, vehicles loaded with irregularly shaped goods or small vehicles (such as bicycles, tricycles and motorcycles).
- ▶ The Adaptive Cruise Control may not respond to slow-moving, parked or approaching vehicles, or other stationary targets.
- ▶ Intersections with traffic lights cannot be recognized, and the driver

needs to take over the vehicle control.

- ▶ Do not use the Adaptive Cruise Control under poor driving conditions, such as urban roads or other environments with serious traffic congestion, roads with a large amount of accumulated water or silt, severe rain and snow, low visibility, windy weather and ramps.
- ▶ Adaptive Cruise Control may not respond to vehicles or objects crossing the lane.
- ▶ Too many objects in the boot may result in vehicle posture change, causing target identification performance degradation or Adaptive Cruise Control failure.
- ▶ When another vehicle changes lane and goes to the front of the vehicle, the Adaptive Cruise Control may not be able to respond immediately. The driver shall brake in time.
- ▶ During driving on a steep downhill slope, it is hard for the Adaptive Cruise Control to keep an appropriate distance from front vehicles. You should be much more careful under such circumstance and prepare for braking.
- ▶ During driving into and out of curves, the selection of targets may be delayed or disturbed. Adaptive Cruise Control may brake unexpectedly, brake too late, or accelerate.
- ▶ On sharp curves, such as s-shape roads, due to the limitations of cameras and front radars, Adaptive Cruise Control cannot detect the vehicle ahead normally, which may cause the vehicle to accelerate, and thus the driver needs to take over this vehicle properly according to the actual conditions.
- ▶ When a vehicle ahead in the adjacent lane cuts into the driving track of the vehicle, the detection may be affected or delayed in some environments, such as low reflection intensity of targets (pedestrians, bicycles and tricycles), and

electromagnetic interference, which leads to the Adaptive Cruise Control unable to recognize the target or accurately calculate the distance from the vehicle ahead. In this case, Adaptive Cruise Control will be unresponsive or delayed in braking, and the driver needs to actively control the vehicle.



- ▶ Road construction (failure in object recognition, such as conical road-blocks and road construction signs).

ⓘ Install the front license plate frame with caution, because the wide metal plate frame can affect the front radar signal, and cause the front radar to incorrectly handle the vehicle's driving status or produce false alarms.



ⓘ Adaptive Cruise Control can speed up and slow down the vehicle. When the vehicle decelerates, the braking system works and may make a sound. It is normal.

If the vehicle under Adaptive Cruise Control is too close to the forward vehicle, Front Collision Mitigation may be triggered by Adaptive Cruise Control.

Setting Adaptive Cruise Control to the ready mode

Press the button   on the left of the steering wheel and select smart Pilot Assist/Adaptive Cruise Control/Cruise Control (if equipped)/Speed Limiting according to vehicle configuration. Press the button



 on the left of the steering wheel to activate and enable the selected function.

When the button   on the left of the steering wheel is pressed to Adaptive Cruise Control and the grey/white indicator  on the driver information display illuminates, Adaptive Cruise Control is in the ready mode.

Enabling Adaptive Cruise Control



- Doors, bonnet and liftgate need to be closed.



- Fasten the driver's seat belt.
- The performance of the brake system is normal.
- The electric parking brake is released.
- Electronic Stability Control is not deactivated.
- The vehicle speed is within 0 - 150 km/h (0 - 94 mph).
- The gear position is in drive **D**.
- The camera and the front radar area are not covered by dust, rain, ice, snow or other dirt.
- Hill Descent Control is not activated.

When the button  on the left of the steering wheel is pressed and the green indicator  on the driver information display illuminates, the current vehicle speed is set as the cruise speed.

Adjusting Adaptive Cruise Control

When Adaptive Cruise Control is working, you can set the target speed and vehicle following distance interval according to needs.

After Adaptive Cruise Control is enabled, press the button   on the left of the steering wheel to adjust the vehicle following distance. The lowest level is level 1 and the highest level is level 3. When the lowest/highest level is selected, pressing again will be invalid.

The driver can adjust the Adaptive Cruise Control speed through the button   on the left of the steering wheel.

Press the button  on the left of the steering wheel: a short press increases the speed by 1 km/h (1 mph), and a long press increases it by 5 km/h (3 mph).

Press the button  on the left of the steering wheel: a short press decreases the speed by 1 km/h (1 mph), and a long press decreases it by 5 km/h (3 mph).

When Automatic Speed Limiting is enabled, if a speed limit sign on the road is detected and the currently set speed is higher than the speed limit, the system will automatically adjust the target speed to the speed limit. If the set speed is lower than the

speed limit, the set speed will remain the same.

Enabling/disabling Automatic Speed Limiting



Enter the Settings interface:

- Tap  > *Driving Assistance* > *Assistance* > *Automatic Speed Adjustment* to turn on/off the automatic speed adjustment.

 In case of accidents, your response time will be limited if following distance is short. You are always obligated to control the vehicle and keep safety distance.

- When the Adaptive Cruise Control is active, if the driver steps on the accelerator pedal, the vehicle control will be taken over by the driver to respond to the acceleration demand. The control function of the Adaptive Cruise Control will not work.
- The higher the vehicle speed, the longer the car-following distance.

Disabling Adaptive Cruise Control



When the button  on the left of the steering wheel is pressed and Adaptive Cruise Control enters the ready mode, the grey/white indicator  on the driver information display illuminates, indicating that Adaptive Cruise Control is in the ready mode, and Adaptive Cruise Control no longer controls the vehicle speed.

Adaptive Cruise Control will automatically enter the ready mode particularly for any of the following reasons:

- Any of the doors, the bonnet or the lift-gate is opened.
- The driver's seat belt is unfastened.
- The braking system has degraded performance or fails.
- Electronic parking brake is enabled.
- The wheels lose traction.
- The vehicle speed exceeds the set value and keeps longer than the design time.
- The shift lever is set to the **N** position, **R** position or **P** position.

- The Electronic Stability Control is turned off or subject to intervention.
 - Hill Descent Control is activated.
 - The camera and the front radar area are covered by dust, rain, ice, snow or other dirt.
- ⓘ After Front Cross Traffic Alert exits automatically, you must take over the vehicle control to ensure the safe driving of the vehicle.

Re-enabling Adaptive Cruise Control

Press the button  on the left of the steering wheel to re-enable the Adaptive Cruise Control, so the indicator light  on the driver information display turns green.

- ⓘ If current speed and target speed are quite different, the speed will increase gradually after reactivating Adaptive Cruise Control.

Car-following mode of Cruise Control

In the car-following mode of Cruise Control, if the front vehicle stops gradually, the vehicle will also stop gradually following the front vehicle and keep a safe distance.

- In 4 seconds after the vehicle stops, if the front vehicle resumes driving, the Cruise Control will automatically resume.
- When the following stop time is more than 4 seconds, the system will determine the surrounding conditions and the driver's status. If the automatic resume requirement is not met and the vehicle ahead runs, the driver needs to press the accelerator pedal or press the button  on the left of the steering wheel to resume Cruise Control.
- When the following stop time is more than 3 minutes, Adaptive Cruise Control will be deactivated automatically.
- If the driver actively exits the Adaptive Cruise Control, the vehicle will not move forward automatically. If the accelerator pedal is pressed at this time and the vehicle moves forwards, the driver

needs to take over the vehicle control and pay attention to safe driving.

- ⓘ When the vehicle enters, exits or drives in a curve, if the vehicle in front goes out of the sensors' detection range, the vehicle may accelerate suddenly. The driver must keep careful and be ready to take over the vehicle at any time.

Changing the target vehicle of Adaptive Cruise Control

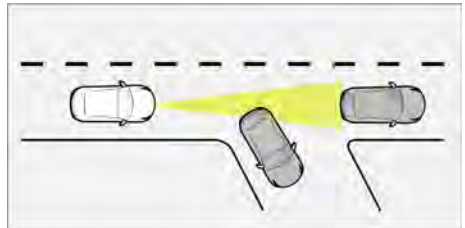

After the Adaptive Cruise Control is activated, if the followed target vehicle suddenly turns and another stationary vehicle appears ahead, the system may not respond to the stationary vehicle and may accelerate to the previously set target speed. Press the brake pedal for deceleration/braking.

Highway Assist (HWA) (if equipped)

Highway Assist (smart Pilot Assist  shown on the driver information display) provides longitudinal and lateral control of the vehicle in the speed range of 0 – 130 km/h (0 – 80 mph) and when the system requirements are met. The system can control the vehicle speed according to the set vehicle speed and the inter-vehicle space, and assist steering wheel control according to the lane lines on the left and right sides or following the lead vehicle. Automated Lane Change Assist can be activated by operating the lever switch of turn signal lamp.

Overtaking avoidance:

When the Highway Assist (i.e., smart Pilot Assist  shown on the driver information display) is activated and the vehicle speed is in the range of 50 – 130 km/h (31 – 80 mph), if the vehicle needs to overtake a

truck, trailer or other large vehicles in adjacent lanes, the system will automatically control the vehicle for avoidance in current lane.

Hands-off alarm:

When Highway Assist (smart Pilot Assist  shown on the driver information display) works, you need to hold the steering wheel. When the system detects that your hands are off the steering wheel for a long time, the system will react:

- When the system detects that your hands hold the steering wheel, the reminder message will disappear. Highway Assist continues to work.
- When the system detects that your hands are still off the steering wheel, the request will be upgraded, a buzzer alarm will be sent, and a reminder message will be displayed. If the driver ignores the reminder, the system will automatically exit Highway Assist after the buzzer alarm ends.

The following scenarios will affect the accuracy of hands-off detection:

- The driver intentionally grips the steering wheel gently.
- Complicated roads such as bumpy roads and potholes.
- Some objects are placed on the steering wheel.

Automated Lane Change Assist:

After enabling the function, the driver can activate Automated Lane Change Assist by turning on the turning signal light when the vehicle is on highways and viaducts, and the surrounding conditions meet the lane change requirements. When the function is activated (→ [Page 124](#)), the system will control the vehicle to change lane automatically.

WARNING Risk of accident when using Highway Assist

- ▶ Highway Assist is only an aid, and it cannot realize complete automatic driving. You are always responsible for driving the vehicle safely and observing local laws and regulations.
- ▶ Highway Assist is only applicable to enclosed roads such as highways and viaducts. Meanwhile, the driver shall pay attention to driving so as to take over the vehicle rapidly in case of emergency.
- ▶ If Highway Assist cannot keep an appropriate speed or a safe distance from the front vehicle, you must intervene.
- ▶ Too many objects in the boot may result in vehicle posture change, therefore degrading or disabling the system.
- ▶ When another vehicle changes lane and goes to the front of the vehicle, the system may not be able to respond immediately. The driver shall brake in time.
- ▶ Highway Assist is not an anti-collision system. You are obligated to take brake measures in case of emergency.
- ▶ When driving on a steep downhill road, it is hard for you to keep an appropriate distance with forward vehicle with the function. In these cases, the driver should drive carefully and be ready to brake at any time.
- ▶ Highway Assist may not respond to animals, small vehicles such as bicycles and motorcycles, or stopped vehicles.
- ▶ When the vehicle follows the front vehicle at low speed, the system can control the steering wheel torque according to the trajectory of the front vehicle, and the subject vehicle follows the front vehicle to move slowly laterally. You need to pay special attention to the traffic conditions on the side of the vehicle.

Limitation of Highway Assist



Highway Assist (smart Pilot Assist  shown on the driver information display) may not be able to work normally when driving under the following circumstances:



- Roads with small curve (e.g. ramps, hill ring roads).
- Cross roads or fork roads (change in the number of lanes, such as one to two, two to three, etc. at intersections)
- Bad weather: heavy rain, heavy fog, heavy snow and direct strong light.
- Road construction (failure in object recognition, such as conical roadblocks and road construction signs).
- Pavement with damaged or unclear lane line.
- The driver takes over the vehicle.
- The lane line is covered by sand, dust, water, snow, etc.
- There are wheel marks on a rainy or snowy day, or wheel marks caused by the braking of other vehicles.
- Road boundary, kerb, etc.
- There are continuous linear projections on the road, such as the shadows of railings.

Using Highway Assist

Conditions of using Highway Assist (smart Pilot Assist  shown on the driver information display):



- Doors, bonnet and liftgate need to be closed.
- Fasten the driver's seat belt.
- The performance of the brake system is normal.
- The electric parking brake is released.
- Electronic Stability Control is not deactivated.
- The vehicle speed does not exceed the design speed.
- The gear position is in drive **D**.
- The camera and the front radar area are not covered by dust, rain, ice, snow or other dirt.
- Hill Descent Control is not activated.



Press the button   on the left of the steering wheel and select smart Pilot Assist/Adaptive Cruise Control/Cruise Control (if equipped)/Speed Limiting according to vehicle configuration. Press the button  on the left of the steering wheel to activate and enable the selected function.

Press the button  on the left of the steering wheel to activate and enable the selected function. After the function is activated, when the green indicator  on the driver information display illuminates, the current vehicle speed is set as the cruise speed.

Adjusting Highway Assist

When Highway Assist (smart Pilot Assist  shown on the driver information display) is working, you can set the target speed and the vehicle following distance interval according to needs.

After enabling Highway Assist, press the button   on the left of the steering wheel to adjust the vehicle following distance. The lowest level is level 1 and the highest level is level 3. When the lowest/highest level is selected, pressing again will be invalid.

The driver can adjust the Adaptive Cruise Control speed through the button   on the left of the steering wheel.

Press the button  on the left of the steering wheel: a short press increases the speed by 1 km/h (1 mph), and a long press increases it by 5 km/h (3 mph).

Press the button  on the left of the steering wheel: a short press decreases the speed by 1 km/h (1 mph), and a long press decreases it by 5 km/h (3 mph).

 In case of accidents, your response time will be limited if following distance is short. You are always obligated to control the vehicle and keep safety distance.

- When Highway Assist is working, if the driver steps on the accelerator pedal, the vehicle will be taken over by the driver, responding to the driver's

acceleration needs. The control of Highway Assist will stop working.

- If there is no obvious response after enabling Highway Assist, it means that the set vehicle following distance cannot permit speed increase.
- The higher the vehicle speed, the longer the following distance.
- To make sure to follow the vehicle ahead steadily, Adaptive Cruise Control allows changes of the vehicle following distance under specific circumstance. If the vehicle is running at low speed and the distance to the vehicle ahead is relatively short, Highway Assist will prolong the vehicle following time interval slightly.

Disabling Highway Assist

Highway Assist (smart Pilot Assist  shown on the driver information display) can be disabled in the following ways:



- Press the brake pedal to exit Highway Assist.
- Press the button  on the left of the steering wheel to exit smart Pilot Assist.

Highway Assist relies on other systems to work, such as Electronic Stability Control. If any of these systems stops working, Highway Assist will be automatically disabled. In the case of automatic system deactivation, an audible signal will be emitted and a text message will be displayed on the driver information display. The driver must intervene to maintain a safe speed and distance from the lead vehicle.

The reasons for the deactivation of Highway Assist could be (including but not limited to):

- Any door, bonnet or liftgate is opened.
- The driver's seat belt is unfastened.
- The wheels have lost traction.
- The braking system has degraded or failed.
- The parking brake is applied.
- The front middle range radars and front camera are covered by snow or heavy rain.

Re-enabling Highway Assist

Press the button  on left of the steering wheel to enable smart Pilot Assist again. The green indicator  on the driver information display illuminates.

For detailed operation steps, refer to Adaptive Cruise Control (→ Page 113).

When Automatic Speed Limiting is enabled, if a speed limit sign on the road is detected and the currently set speed is higher than the speed limit, the system will automatically adjust the target speed to the speed limit. If the set speed is lower than the speed limit, the set speed will remain the same.

Enabling/disabling Automatic Speed Limiting

Enter the Settings interface:

- Tap  > *Driving Assistance* > *Assistance* > *Automatic Speed Adjustment* to turn on/off the automatic speed adjustment.

Traffic Jam Assist (TJA) (if equipped)

At the speed of less than 60 km/h(38 mph), Traffic Jam Assist helps the driver prevent accidents by detecting the distance to the forward vehicle and providing a safe distance, and keeps the vehicle in the current lane with steering assist.

Under the active system, the driver needs to control the steering wheel all the time and take over the vehicle by operating the pedal, steering wheel and steering indicator light. If the vehicle detects that the driver does not control the steering wheel, it will issue a warning to remind. If the steering wheel is not controlled, the function will be suspended.

Traffic Jam Assist will be limited under the following conditions:

- The front view camera or radar is covered.
- There are many obscure lane markings on a lane, e.g. in a construction zone.
- The distance to the forward vehicle is too small.

- Lane markings change rapidly, such as lane diverging, crossing or merging.
- Traffic Jam Assist cannot provide assistance when the road is narrow, the corner is sharp, or the turning is rapid.

Lane Keeping Assist (LKA)

When you are driving on a highway or main road, Lane Keeping Assist can reduce the risk of a vehicle deviating from its own lane in certain circumstances.

If the vehicle travels at the speed within 65–180 km/h (41–110 mph), the Lane Keeping Assist can identify lane markings, pedestrians, kerbside and front/rear vehicles and measure the distance between the left and right lane markings of the current lane and the vehicle through the windscreen camera, front radar and rear radars on both sides. If Lane Keeping Assist detects that the vehicle is in danger of deviating from the lane and colliding with pedestrians or vehicles in the adjacent lane, the system will request the vehicle to turn back to its own lane. When the vehicle is about to deviate from the lane or is deviating from the lane, the system will remind the driver to control the vehicle in the lane by vibrating the steering wheel or sending sound and visual signals.

NOTE

- ▶ Lane Keeping Assist only provides assistance, and it cannot operate normally under all driving conditions, weather conditions, traffic conditions or road conditions.
- ▶ Do not use this function in urban streets, construction areas, narrow roads or sections where there may be cyclists or pedestrians.
- ▶ You are always responsible for driving your vehicle safely and abiding all relevant traffic laws and regulations.

Limitations of Lane Keeping Assist

This system may be unable to cope with some traffic, weather and road conditions. You are advised not to rely too heavily on

the system because it may not work properly, in case of:

- Poor road conditions or road construction (failure in recognizing objects such as conical roadblocks and road construction signs).
- Driver's active intervention.
- Complicated lane markings on roads.
- Low visibility due to bad weather.
- The Electronic Stability Control is turned off or subject to intervention.

The Lane Keeping Assist consists of three subsystems:

- Lane Departure Warning (LDW)
- Lane Departure Prevention (LDP)
- Emergency Lane Keep Assist (PLUS) (ELKA PLUS)

Lane Departure Warning (LDW)

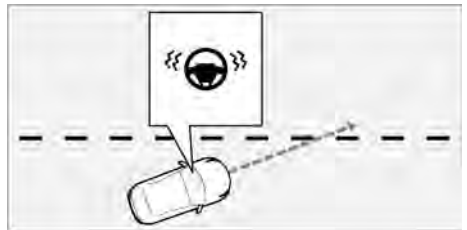

If the driver does not actively control the vehicle and the system detects that the vehicle is about to cross the lane marking, the Lane Departure Warning will remind the driver by vibrating the steering wheel or giving audible and visual signals.

Turning on/off Lane Departure Warning

Enter the setting interface:

- Tap  > *Driving Assistance* > *Safety* > *Lane Departure Warning* to set Lane Departure Warning to Off, Vibration or Beep mode.

Lane Departure Prevention (LDP)

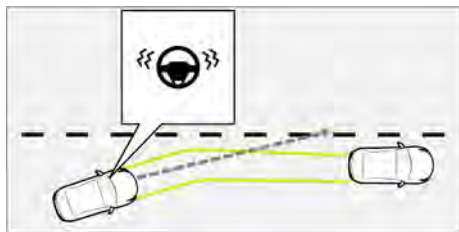

If the driver does not actively control the vehicle and the system detects that the vehicle is deviating from the current lane, the Lane Departure Prevention will actively request steering to help the vehicle return to the current lane. If the vehicle continues to deviate from the lane and is about to cross or crossing the lane line, Lane Departure Prevention will issue a warning if Lane Departure Warning is enabled.

Emergency Lane Keep Assist (PLUS) (ELKA PLUS)

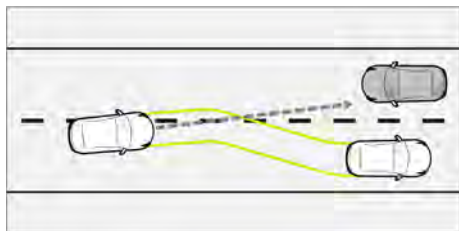

Emergency Lane Keep Assist (PLUS) will actively control the steering system to help the vehicle return to the current lane when the vehicle travels on a road with clear lane lines or road boundary, the system detects that the vehicle is deviating from the current lane and any of the following situations occurs:

- The vehicle is in danger of colliding with an oncoming vehicle or an approaching vehicle from the rear in the neighboring lane.
- The vehicle is in danger of colliding with the kerb or running off the road.
- The vehicle is in danger of colliding with pedestrians, bicycles, etc. in the adjacent lane.

Enabling/disabling Emergency Lane Keep Assist (PLUS)

Enter the setting interface:

- Tap  > *Driving Assistance* > *Safety* > *Emergency Lane Keep Assist* to enable/disable the Emergency Lane Keep Assist (PLUS).

Notes on Emergency Lane Keep Assist (PLUS):

- The Emergency Lane Keep Assist (PLUS) only provides assistance, and it cannot operate normally under all driving conditions, weather conditions, traffic conditions or road conditions.
- The Emergency Lane Keep Assist (PLUS) cannot detect obstacles like roadside fences and railings.
- The Emergency Lane Keep Assist (PLUS) is enabled only when there is a high risk of collision. Do not wait for this function to intervene.
- The driver shall always keep attention and judgment to ensure that the vehicle drives safely at an appropriate speed, keeps an appropriate distance from other vehicles, and abides by current laws and traffic regulations.



NOTE

- ▶ When driving on sharp curves or narrow roads, the lane keeping assist may not work.
- ▶ When the vehicle is running normally, if you turn on the turning signal lights, Lane Keep Assist will not issue warning or intervene, except in the case of vehicles coming from behind.
- ▶ When Electronic Stability Control fails or is disabled, or the vehicle is interfered with, Lane Keep Assist may be restricted or unavailable.
- ▶ After this function is disabled, the system will not be able to provide steering control in emergency situations, and may not be able to actively avoid the risk of collision with kerbs or adjacent targets.



Hands-off alarm

When the Lane Keep Assist is activated, the driver needs to hold the steering wheel with both hands at all times. If Lane Keep Assist does not detect hands on the steering wheel when it is activated for the first time, no reminder message will appear on the driver information display and the corresponding lane lines turn blue. If the Lane Keep Assist is activated again in the next period of time and still detects that the driver's hands are not on the steering wheel, the corresponding warning message will pop up on the driver information display, accompanied by an audible alarm, until the driver takes over the vehicle control. The alarm is turned off.

Enabling/disabling Lane Keeping Assist

- Tap  >  to enable/disable Lane Keeping Assist.
- Enter the setting interface:
Tap  > *Driving Assistance* > *Safety* > *Lane Keep Assist* to enable/disable Lane Keep Assist.

NOTE

- ▶ After Lane Keeping Assist is turned on, if the system fails, the indicator lamp  on the driver information display will come on.
- ▶ After Lane Keeping Assist is turned off, the indicator lamp  on the driver information display will come on.
- ▶ When Lane Keeping Assist is not activated, the lane lines displayed on the driver information display are grey.
- ▶ When Lane Keeping Assist detects the lane lines and is ready to work, the lane lines displayed on the driver information display are grey.
- ▶ When Lane Keeping Assist issues an alarm, the lane lines displayed on the driver information display are yellow.
- ▶ When Lane Keeping Assist initiates torque intervention on the steering wheel, the lane lines displayed on the driver information display are blue.

Lane Change Assist (LCA)

With the vehicle speed within 15–155 km/h, when the driver enables this function, if there is a vehicle in the blind spots of the vehicle or a vehicle behind within 70 meters in the adjacent lane is approaching quickly, the system will warn the driver by turning on or flashing the warning light on the outside rearview mirror and the alarm screen on the driver information display.

Lane Change Assist consists of the following sub-systems:

- **Blind Spot Detection (BSD):** when the Blind Spot Detection detects one or more vehicles, the system will warn the driver by turning on or flashing the warning lamp on the rearview mirror and the alarm image on the driver information display.
- **Coming Vehicle Warning (CVW):** when the Coming Vehicle Warning system detects that there are fast approaching

vehicles in the lanes on either side, the system will warn the driver by turning on or flashing the warning lamp on the rearview mirror and the alarm image on the driver information display.

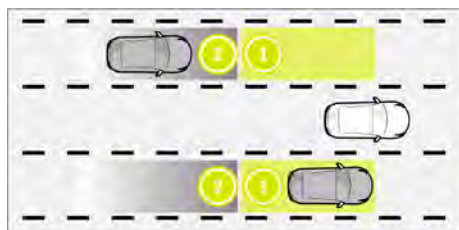

- 1 Detection area of Blind Spot Detection
- 2 Detection area of Coming Vehicle Warning/Lane Change Collision Warning Beep

⚠ WARNING Risk of accident due to incorrect use of Lane Change Assist

- ▶ Lane Change Assist is an information system, and it cannot work properly under all circumstances.
- ▶ To make sure lane change safety, the driver must pay attention to the vehicle from the sides and rear before changing lane, even if the vehicle is equipped with Lane Change Assist.
- ▶ Lane Change Assist does not work when reversing.

Limitations of Lane Change Assist

The function may be affected, particularly when:

- Lane Change Assist is not suitable for rain, snow and other severe weather.
- Lane Change Assist cannot detect stationary object.
- Lane Change Assist cannot detect objects such as pedestrians or bicycles.
- Lane Change Assist does not work in tight corners or open areas.
- Lane Change Assist cannot detect fast or slow vehicles.

- Lane Change Assist cannot detect small objects.

Turning on/off Lane Change Collision Warning Beep

Enter the setting interface:

- Tap > *Driving Assistance* > *Assistance* > *Lane Change Collision Warning Beep* to set Lane Change Collision Warning Beep to Off, Visual, or Visual & Audio.

Automated Lane Change Assist (ALCA) (if equipped)

After Highway Assist is enabled, when the vehicle speed is between 60 - 130 km/h (38 - 80 mph) and Automated Lane Change Assist is enabled, if the system detects that the current road conditions meet the Automated Lane Change Assist requirements, the driver can toggle the turning signal light switch to achieve the Automated Lane Change Assist function.

Limitations of Automated Lane Change Assist

- Automated Lane Change Assist helps the vehicle change into one lane at a time. The second change requires turning on the turning signal light again after completing the first lane change.
- If the driver activates the Automated Lane Change Assist, the turning signal lights will flash continuously during lane change; after the lane change is completed or fails, the driver needs to turn off the turning signal lights manually.
- The driver shall not take hands off the steering wheel during lane change. If the system detects the driver's intervention (such as turning in reverse or pulling the steering wheel), the lane change will be canceled or fail.
- The system cannot guarantee successful lane change every time. During lane change, the driver shall always keep the control of the vehicle.

Enabling conditions of Automated Lane Change Assist:

- The road is not under construction (which may lead to failure in object

recognition, such as conical roadblocks and road construction signs).

- Expressways or viaducts with clear barriers.
- Good network (complete map data).
- The road speed limit is not less than 70 km/h(44 mph); the vehicle speed exceeds 60 km/h(38 mph).
- The driver holds the steering wheel with both hands and turns the steering column lever.
- The width of the target lane is 2.5–5.5 meters, and there is no dangerous environment (such as road construction, and road curvature greater than 250 meters).
- There is enough space in the target lane, and there are no fast approaching vehicles behind.
- The corresponding lane marking is a dotted line.
- The lane markings on both sides are displayed in green.
- The Electronic Stability Control is not turned off or subject to intervention.

Enabling/disabling Automated Lane Change Assist

Enter the setting interface:

- Tap  > *Driving Assistance* > *Assistance* > *Auto Lane Change Assistance* to enable/disable Automated Lane Change Assist.

⚠ WARNING Risk of accident from using Automated Lane Change Assist

- ▶ Automated Lane Change Assist is only an aid, and you need to observe the surroundings and hold the steering wheel while the vehicle is changing lane automatically in order to take over the vehicle in time in case of an accident.
- ▶ You are always responsible for driving your vehicle safely and abiding all relevant traffic laws and regulations.

! NOTE

- ▶ Automated Lane Change Assist helps the vehicle change into one lane at a time. The second change requires turning on the turning signal light again after completing the first lane change.
- ▶ If the driver moves the left lever to turn on the turning signal light and activate Automated Lane Change Assist, the turning signal light will keep flashing during the lane change. After the completion or failure of lane change, the turning signal light turns off automatically. After the function is activated, if the turning signal light is not automatically turned off, the driver shall manually turn it off after the lane change is completed or fails.

Front Collision Mitigation (FCM)

The Front Collision Mitigation can warn the driver to pay attention to pedestrians, cyclists and other vehicles by means of tone, image and braking. When the driver brakes too late, the braking force is too small or there is no braking measure at all, the system will take measures to help the driver to avoid or mitigate a collision. The driver or passenger usually only notices the Collision Mitigation function when the vehicle is about to collide.

Front Collision Mitigation works through the following 4 methods:

1. **Safe distance alarm:** if the vehicle traveling at a speed higher than 65 km/h (41 mph) is too close to the front vehicle, the system will remind you to keep a safe distance through visual signals.
2. **Front Collision Warning (FCW):** when the vehicle speed is higher than 10 km/h(7 mph), if the system judges that there is a potential collision risk, it will alert the driver of a potential collision risk by an audible alarm or alarm image on the driver information display.
3. **Emergency brake assist:** if the vehicle speed is over 30 km/h(20 mph), and the

risk of collision increases, the brake assist will be enabled. If you do not apply enough force to the pedal, this function will increase braking.

4. **Autonomous Emergency Braking (AEB):** When the system detects a risk of collision, there is no driver input, and the collision cannot be avoided by steering, the system will activate Autonomous Emergency Braking. Autonomous Emergency Braking can avoid collision or reduce the speed of collision by applying maximum braking force.

Working conditions of Autonomous Emergency Braking:

- If there are pedestrians and bicycles in front of the vehicle, the working speed of the Autonomous Emergency Braking is 5 – 85 km/h (3 – 55 mph).
- If there are other vehicles and motorcycles in front of the vehicle, the working speed of the Autonomous Emergency Braking is 5 – 150 km/h (4 – 94 mph).

When using Front Collision Mitigation, please particularly pay attention to the following:

- The system will perform self-check when the vehicle is started, and the function will not be available at this stage.
- This function will not be activated when the driver does not wear the seat belt.
- No system can guarantee 100% normal operation under all circumstances. Autonomous Emergency Braking is an emergency safety feature, therefore, do not drive the vehicle towards people or objects for the purpose of testing the performance of Front Collision Warning/Autonomous Emergency Brake. It may cause accidents and casualties.
- For drivers, Front Collision Mitigation is an aid. It is always the driver's responsibility to maintain a proper speed and keep a proper distance from the vehicles ahead. Do not wait for Front Collision Warning to signal or Autonomous Emergency Braking to intervene.

- Front Collision Mitigation may not work in some driving conditions, traffic conditions, weather conditions or road conditions.
- Due to the limitation of sensor characteristics, the Front Collision Mitigation performs differently for targets identified, which depends on the specific vehicle, scenarios and road conditions. Autonomous Emergency Braking does not guarantee collision avoidance in all scenarios.
 - For targets that are stationary or moving slowly ahead, the system may not be able to intervene in time.
 - When the vehicle's relative speed to the vehicle in front is too high, the system may not be able to intervene in time.
 - On a curve/ramp, the system performance may be affected, and false trigger may occur due to the limitation of road conditions.
 - When other vehicles cut into the front road of the vehicle quickly, or when the vehicle suddenly cuts into the rear road of other vehicles, the system may not respond in time.
 - In some specific scenarios, such as metal manhole cover, billboard, speed bump, fence and other similar combined scenarios, the system may not accurately identify the corresponding target, and may misjudge and cause unnecessary alarm or braking.
 - When the vehicle is driving on a slope, such as driving uphill or downhill in an underground parking lot, the function may be triggered by mistake.
 - The system can't recognize retrograde vehicles and can't respond in time.
- The function is disabled at low speeds. The system does not intervene in braking when the vehicle approaches another vehicle or a pedestrian ahead at a low speed.

- ① When the vehicle is reversing, Front Collision Mitigation system will not work.

When the vehicle speed is lower than 4 km/h(3 mph), Autonomous Emergency Brake will not work.

Detection objects

The Front Collision Mitigation detects pedestrians, cyclists and various vehicles (buses, trucks, passenger cars, etc.) moving in front of your vehicle.

When detecting pedestrians/cyclists, the Front Collision Mitigation needs to obtain the following exact information: pedestrian's head, arms and shoulders, legs, upper and lower parts of the body, and normal movement patterns of pedestrians.

Pedestrian/cyclist detection by the Front Collision Mitigation is a driver assistance function. It cannot detect:

- Pedestrians/cyclists who are partially obscured and who wear clothes not suitable for forming a clear image of their body outline.
- Pedestrians/cyclists who are not in strong contrast with the background. The warning or braking of the system will be delayed, or the system will not give warning or take braking at all.
- Pedestrians/cyclists carrying large objects.

Limitations of false trigger of Front Collision Mitigation

- Bad weather, such as heavy rain, heavy fog, heavy snow and direct strong light.
- False trigger due to limitations of sensors. For example, as there are many pedestrians in the downtown area, the target may repeatedly enter and exit the driving trajectory of the vehicle, which leads to target misjudgment by the sensors, and triggers an alarm.
- When there is a target feature of a vehicle, cyclist, pedestrian, etc. in the vehicle's trajectory, but there is no real target, misjudgment may occur and an alarm may be triggered.

- When the vehicle is driving on a slope, such as driving uphill or downhill in a underground parking lot, false alarm may be triggered.

Limitations of Front Collision Mitigation

The Front Collision Mitigation works relying on cameras and radars. The system functionality may be limited or reduced, particularly when:

- Driving on wet roads: Wet road leads to a longer braking distance, which reduces the anti-collision performance of Front Collision Mitigation.
- Strong external lighting: Strong sunlight, reflections, and extreme light contrasts may make it difficult for the driver to see visual warning signals, or may also affect the detection of cameras.
- High temperature in the passenger cabin: If the passenger cabin has high temperature, the camera may be temporarily turned off and the system may not issue a warning.
- Low visibility in bad weather: Heavy snowfall, high blowing snow, rain, fog and dusty weather affect the windscreen and front bumper and may reduce system function.
- Limited view fields of cameras/radars: The view fields of cameras and radars are limited. In some cases such as when the camera is blocked or the environment is dark, the system may take longer than expected to detect other vehicles or pedestrians or completely fail to detect them.
- Driver initiative: If the driver controls the vehicle/brakes actively, the system may not respond or respond later than expected.

Turning on/off Forward Collision Mitigation

Enter the setting interface:

- Tap  > *Driver Assistance* > *Safety* > *Forward Collision Mitigation* and set the Forward Collision Mitigation to the Off, Near Distance, Medium Distance or Far Distance mode.

Forward Collision Mitigation is enabled by default, and cannot be turned off when the vehicle speed exceeds 10 km/h (7 mph). If the driver wishes to disable the function, park the vehicle in a safe place before disabling.

When the driver selects the Off option, the system will remind the driver to confirm again. If the driver confirms, the system will no longer provide Forward Collision Warning and Autonomous Emergency Braking functions. Drive carefully and be safe.

Rear Collision Mitigation (RCM)

When the user activates this function, a gear other than reverse **R** is engaged, the vehicle travels at the speed of 0 - 150 km/h (0 - 94 mph), and the system detects the risk of rear collision, it reminds the driver through sound and visual signals, and turn on the hazard warning light to remind the driver of rear vehicle to brake.

Detectable objects of Rear Collision Warning:

- Motor vehicles
- Electric bikes, motorcycles

Limitations of Rear Collision Mitigation

Rear Collision Mitigation may be affected particularly when:

- The target vehicle is approaching your vehicle quickly, with too fast relative speed which is beyond the range of sensor detection.
- If the target vehicle approaches slowly behind your vehicle and is detected late.
- Target vehicle is approaching you after lane change from the other lane.

Turning on/off Rear Collision Mitigation

Enter the setting interface:

- Tap  > *Driving Assistance* > *Safety* > *Rear Collision Mitigation*, and turn on/off the Rear Collision Mitigation.

Front Cross Traffic Alert (FCTA)

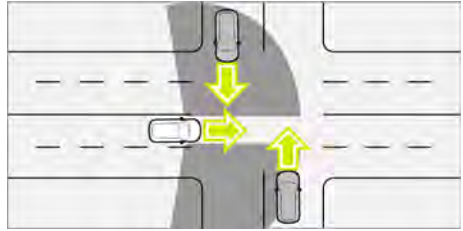

When driving forward out of a parking space or through an intersection with impaired vision, Front Cross Traffic Alert alerts the driver to brake to reduce the risk of forward side impact.

If the system detects the risk of front side collision, the driver information display will pop up a warning and make an audible alarm to remind the driver.

The system is enabled only when the vehicle is moving forward at the speed of 4 - 15 km/h (3 - 10 mph) and the target vehicle at the speed of 10 - 60 km/h (7 - 38 mph).

Rear Cross Traffic Alert (RCTA)

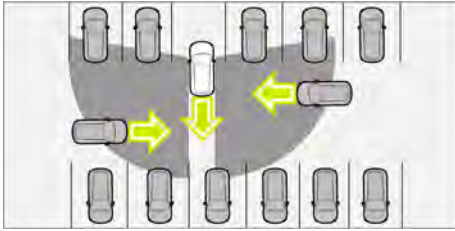

When you are reversing out of your parking space or garage, Rear Cross Traffic Alert alerts you of the vehicle in the rear to avoid collision if there is a risk of a side collision. If necessary, brake will be applied automatically.

If the vehicle is shifted to **R** or **N** gear, with the speed of 0 - 18 km/h (0 - 12 mph), RCTA will be enabled.

If the system detects the risk of rear side collision, the warning message will pop up on the central display and the warning mark on the outside rearview mirror will be lit, with an acoustic alarm, to remind the driver.

Limitations of Rear Cross Traffic Alert:

- Restricted driver assistance system sensors may cause Rear Cross Traffic Alert to work improperly.
- Never install accessories such as decals in the rear radars and their surrounding areas. Otherwise, the working range of the sensors may be affected, thus causing some driver assist systems to fail to work.
- Severe weather conditions, such as heavy snow, heavy rain, and fog, may weaken the sensors or cause the system to temporarily stop working.
- The rear radar may be interfered by other radio devices or strong radar reflections.
- In some cases, the rear radar may take longer than expected to detect other vehicles or completely fail to detect them.
- When a vehicle is driving on the winding, narrow and steep roads or entering

or exiting a tunnel, the rear radar may fail to detect rear vehicles or other obstacles.

- Never slam into the sensor or the surrounding area.
- The cracks/scratches or stone chips in the rear bumper area behind the rear radar affects the rear radar function.
- To make sure the sensors work normally, the sensor area must be free from dust, ice, snow, or other dirt, and the area must be cleaned regularly.
- This function does not work on stationary or slow moving targets.
- The target is approaching too fast.

NOTE

Although the vehicle is equipped with Front Cross Traffic Alert, always look around and make sure the surrounding is safe before reversing.

In the following cases when the two front corner radars are blocked by the surrounding vehicles and obstacles, the Rear Cross Traffic Alert is unable to detect the direction of oncoming vehicles in time.

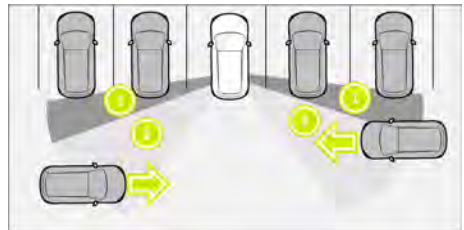

- ① Blind spot (sensor view blocked)
- ② Detected area

Enabling/disabling Rear Cross Traffic Alert

Enter the setting interface:

- Tap > *Driving Assistance* > *Safety* > *Rear Cross Traffic Alert*, and set the Rear Cross Traffic Alert.

Door Opening Warning (DOW)

When the vehicle is stationary or runs at the speed lower than 3 km/h (2 mph), DOW is enabled (if already activated) to detect

the traffic conditions on the side and rear. If a collision risk is detected when you open the door, the driver information display will show a corresponding prompt to warn the driver or passenger not to open the door to avoid collision.

When the vehicle speed is higher than 5 km/h (4 mph), the DOW is limited.

Limitations of Door Opening Warning

Door Opening Warning may not work properly in some situations:

- For vehicles that move too fast.
 - For small size of targets.
 - For stationary or slow-moving targets.
 - For targets coming in opposite directions.
 - In bad weather like rain or snow.
 - In sharp turns, downhill, narrow or wide lanes.
 - For vehicles approaching or leaving quickly.
- ⓘ When opening doors, pay attention to other road users to avoid collision risk.

Detection objects

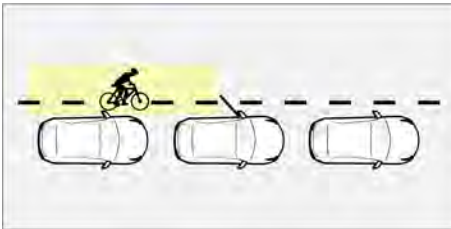

Objects to be detected by Door Opening Warning:

- Motor vehicles
- Electric bikes, motorcycles
- Bicycle

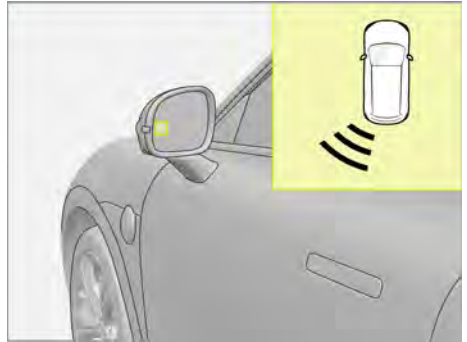

If Door Opening Warning detects the target and a collision risk when the door is open, the system will flash the outside rearview mirror indicator and issue a sound warning, and the driver information display will show the corresponding object warning prompt.

- ⓘ Never stick any object on the lens of the outside rearview mirror to avoid affecting the operation of Door Opening Warning.
- ⓘ If Door Opening Warning failure or similar information is indicated on the driver information display, contact the smart Authorized Service Partner immediately. Otherwise, Door Opening Warning may not work normally.

Enabling/disabling Door Opening Warning

Enter the setting interface:

- Tap  > *Driving Assistance* > *Safety* > *Door Open Warning* to enable/disable Door Open Warning.

Evasive Maneuver Assist (EMA)

⚠ WARNING Possible risks caused by use of Evasive Maneuver Assist

- ▶ Evasive Maneuver Assist only provides assistance, and it may not operate normally under some driving conditions, weather conditions, traffic conditions or road conditions.
- ▶ You are always responsible for driving your vehicle safely and abiding all all relevant traffic laws and regulations.

The system can help you mitigate the risk of collision when your vehicle is rapidly approaching another one which is stationary or moving in the same direction.

The system is activated only when:

- The system detects that the subject vehicle is about to collide with the forward vehicle.
- You turn the steering wheel to steer around the target vehicle.

When the Evasive Maneuver Assist detects that the vehicle is about to collide and the driver turns the steering wheel to avoid collision, the Evasive Maneuver Assist will improve the steering force of the vehicle and assist the driver in collision avoidance; after the Evasive Maneuver Assist is activated, the driver information display will remind the driver that the Evasive Maneuver Assist is active.

Notes on Evasive Maneuver Assist

- The system does not automatically bypass the target vehicle. It will not activate if you do not turn the steering wheel.
- It will not activate if you are too close to the vehicle ahead and the collision cannot be avoided.
- The Evasive Maneuver Assist is an emergency safety function, and it cannot avoid collision in all scenes.
- Do not test the Evasive Maneuver Assist on actual roads under guidance of non-professionals.

Limitations of Evasive Maneuver Assist

The functions of Evasive Maneuver Assist may be affected particularly in the following situations:

- When you are reversing, the system does not work.
- When the vehicle speed is under 50 km/h or over 100 km/h.
- When the vehicle is connected with a trailer.
- When collision risk is detected in neighboring lanes.
- When there is a risk of vehicles crossing the kerb.
- When Electronic Stability Control fails, shuts down or interferes with the vehicle.
- The driver steps on the accelerator pedal deeply.
- The driver does not turn the steering wheel or turns the steering wheel too late.

Traffic Sign Recognition (TSR) (if equipped)

Traffic Sign Recognition includes Speed Limit Information Function (SLIF), which acquires speed limit sign, prohibition sign and other road traffic sign information through cameras and map, and reminds the driver of current road sign information in real time through the driver information display and head up display. If the vehicle exceeds the speed limit of the current road, the system will give an alarm to the driver to remind him or her of driving properly.

Traffic Sign Recognition is designed to remind you of current road regulations and help you maintain a legal speed and observe local traffic restrictions. You are always responsible for safe driving and abiding by all relevant traffic laws and regulations.

Examples of recognizable traffic signs



The above figure does not cover all traffic signs that can be recognized by the system. Traffic signs may vary from country to country.

The system is not applicable for all situations, only as a speed limit reminder. The driver must actively control the speed of the vehicle, and you are always responsible for driving safely and obeying the traffic rules.

The use of Traffic Sign Recognition maybe affected in the following situations:

- Bad weather: heavy rain, heavy fog, heavy snow and direct strong light.
- A speed limit sign is not clear, distorted, tilted, non-standard, partially blocked, or covered. In this case, the camera identification capability deteriorates, resulting in misidentification or failure to identify.
- The map data is incorrect, not updated or inaccurate. In this case, the traffic sign information may not be displayed or displayed inaccurately.
- Signs that are not within standards or improperly located may cause misidentification.
- Intelligent Speed Assist/Traffic Sign Recognition is affected by the camera field of view, the relative position of the camera and the speed limit/traffic sign, which may misrecognise or fail to recognize the speed limit/traffic sign.

Traffic Sign Recognition has some limitations in some cases:

- Road signs are not above or on the side of the vehicle.
- Traffic signs are irregular.
- Signs are fading.
- Signs are located on a curve.

- Signs are rotated or damaged.
- Signs tower over the highway.
- Signs completely or partially obscured or in a relatively hidden position.
- Signs are completely or partially covered by frost, snow and/or dust.

Enabling/disabling Speed Warning

Enter the setting interface:

- Tap > *Driving Assistance* > *Assistance* > *Speed Warning* to enable/disable the Speed Warning, and drag the display bar to set the speed Warning speed.

Driver Monitoring System (DMS)

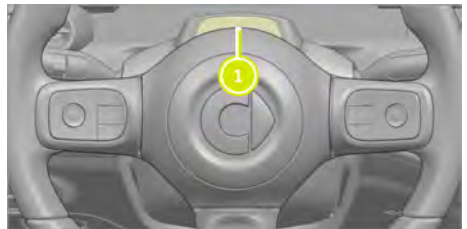

The Driver Monitoring System camera **1** is located on the steering column at the rear of the steering wheel.

Driver Monitoring System is designed to detect the driver status through the driver status monitoring camera. If the driver is determined to be in fatigue driving or distracted driving, the warning prompt will show on the driver information display, with the visual and audible alarms, to remind the driver and make sure driving safety.

⚠ WARNING Risk of accident due to ignoring warnings from Driver Monitoring System

- ▶ Driver Monitoring System is an aid, and it cannot intervene in driving operations. The driver is always responsible for driving the vehicle safely.
- ▶ Never drive when tired. The driver must keep healthy and sober at all times.
- ▶ Never ignore warnings from Driver Monitoring System. If the system issues a warning of fatigue or distracted driving, the driver should adjust his or her driving or stop to take a rest.

i When the system cannot detect the driver's full face, it could produce false alert or report system error, and emit a visual and audio signal. Adjust the steering wheel or the seat position to make sure the camera can be seen in the driving posture and Driver Monitoring System can work properly.

Driver fatigue warning

When the system detects that the driver is in fatigue state, the red indicator  on the driver information display flashes, and a text message and tone occur to remind the driver.

Limitations of Driver Monitoring System

The functions of the Driver Monitoring System may be affected in the following situations:

- The steering wheel is adjusted during driving
- The driver's face is not monitored when the driver sits in a low position or the steering wheel is in a high position.
- The Driver Monitoring System camera is blocked.
- The driver wears sunglasses, mask and other accessories that cover the face.
- Strong lighting reduces the camera detection.
- Driver Monitoring System is activated only when the speed exceeds 10 km/h(7 mph).
- People with special facial expressions (such as too small eye opening).
- i** The driver monitoring system does not record the user data such as face information, voice and image.

Enabling/disabling Driver Monitoring System

Enter the setting interface:

- Tap  > *Vehicle Settings* > *Driving* > *Driver Exhaustion Alert* to disable the Driver Monitoring System.
- i** If the driver monitoring switch is turned off, the Driver Monitoring System will be automatically enabled on the next trip.
- i** When the driver monitoring switch is turned off, only the driver fatigue reminder and distracted driving reminder functions are turned off.

Driver information display

Notes on the driver information display

⚠ WARNING Risk of accident caused by driver information display failure

If the driver information display fails, you may not recognize the functional limitations of safety related systems.

The operating safety of the vehicle may be affected.

- ▶ Drive carefully.
- ▶ Park the vehicle as soon as possible and contact a smart Authorized Service Partner.

⚠ WARNING Risk of interference caused by information system and communication equipment

You may be distracted if you operate the integrated information and communication equipment while driving. You could lose control of the vehicle.

- ▶ Pay attention to the road and traffic conditions, stop the vehicle safely, and then operate the equipment.

Overview of the driver information display

During driving, the driver information display shows



- 1 Power meter/energy regeneration meter
- 2 Display the current vehicle speed
- 3 **Information display area:** driver assistance information/general alarm pop-

up window/charging information/drive mode switch

- 4 Time display
- 5 **Information display area:** trip computer/media information/call information/navigation information/general alarm pop-up window
- 6 Display the endurance mileage
- 7 High voltage battery state of charge
- 8 Display the outside temperature
- 9 Drive mode
- 10 Display the gear

During charging/discharging, the driver information display shows



- 1 Current charged percentage
- 2 Vehicle charging animation
- 3 **Charging display area:** charging time/current charging amperage and voltage/exterior charging and discharging gun connection
- 4 Display the endurance mileage
- 5 Display the gear

When charging/discharging the vehicle, the battery status can be checked on the driver information display.

Door opening status display



When the vehicle is in park **P** /drive **D** /reverse **R** , if any of the doors, the

bonnet, the liftgate or the charging port cover is opened, the door status indicator will display in red, and an alarm will sound to remind the driver of the status of the corresponding door.



When charging/discharging the vehicle, if any of the doors, the bonnet, the liftgate or the charging port cover is opened, the indicator on the driver information display illuminates to remind the driver of the status of the corresponding door.

When a tyre pressure warning is on, the driver information display shows



When the wheel pressure is abnormal, the driver information display shows that the tyre pressure is abnormal to remind the driver to pay attention.

Operating the driver information display

When operating the driver information display, observe the legal requirements of the country or region in which you are driving.

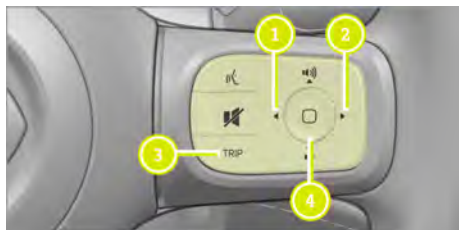

1 ◀ Adjustment button

2 ▶ Adjustment button

3 TRIP Trip button

4 ◻ Setting button

The contents of the driver information display are controlled by the buttons on the right side of the steering wheel. Use 1 and 2 to select the menus.

The menu can be called up from the menu bar on the driver information display and the available menus are as follows:

Trip information

- To open the trip information: press 3 briefly.
- To close the trip information: press 3 briefly.
- To switch trip information: when the trip information is opened, press 1 and 2 briefly to select the trip information.
- To reset the trip information: press and hold 3 to reset the trip information.

Phone

- When there is an incoming call, press 2 briefly to answer the call.
- When there is an incoming call, press 1 briefly to reject the call.

Switch

- Press 1 and 2 briefly to switch media.

Message

- Select a message: when a message is received, press 1 and 2 briefly to select a message.
- Clear a message: when a message is received, short press 4 to clear the message.

Warning lamps and indicator lamps

Indicator and warning lamp icons indicate different functions and faults. Some warning and indicator lamp icons appear with message displays and/or audible signals.

After the vehicle is started, the system conducts a self-check, and some warning lamp icons illuminate for a few seconds and then go out.

During driving, if a warning lamp keeps illuminating, park the vehicle in a safe area and contact a smart Authorized Service Partner.



Low beam indicator lamp: when the low beam is turned on, the indicator lamp illuminates.



Low beam fault indicator lamp: when the low beam is malfunctioning, the warning lamp illuminates.



High beam indicator lamp: when the high beam is turned on, the indicator lamp illuminates.



High beam fault indicator lamp: when the high beam is malfunctioning, the warning lamp illuminates.



Adaptive High Beam indicator lamp: when Adaptive High Beam is in the ready mode, the grey indicator lamp illuminates; when Adaptive High Beam is enabled, the blue indicator lamp illuminates; when Adaptive High Beam is malfunctioning, the yellow indicator lamp illuminates.



Automatic High Beam indicator lamp: when Automatic High Beam is turned on, the grey indicator lamp illuminates; when Automatic High Beam is malfunctioning, the yellow warning lamp illuminates.



Rear fog lamp indicator lamp: when the rear fog lamps are turned on, the indicator lamp illuminates.



Position lamp indicator lamp: when the position lamps are turned on, the indicator lamp illuminates.



Power system fault indicator lamp: when the power system components are malfunctioning, the warning lamp illuminates. In case of the situations above during normal driving, park the vehicle in a safe area and contact a smart Authorized Service Partner. It could be dangerous to continue driving the vehicle.



Electrical power assist steering (EPAS) - speed proportional fault indicator lamp: when the EPAS performance decreases/power assist degraded, the yellow warning lamp illuminates; when the EPAS cannot provide any steering assist, the red warning lamp illuminates. In case of the situations above during normal driving, park the vehicle in a safe area and contact a smart Authorized Service Partner. It could be dangerous to continue driving the vehicle.



Airbag fault indicator lamp: when airbags or seat belt pretensioners are malfunctioning, the warning lamp illuminates. In case of the situations above during normal driving, park the vehicle in a safe area and contact a smart Authorized Service Partner. It could be dangerous to continue driving the vehicle.



Trailer module fault indicator lamp: when the trailer module is malfunctioning, the warning lamp illuminates.

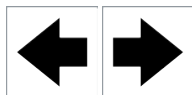

Turning signal light indicator lamp: when the turning signal lights are on, the corresponding indicator lamp flashes. When the hazard warning lights are turned on, the turning signal light indicator lamps on both sides flash.

AFS

Adaptive front illumination system fault indicator lamp: when the adaptive front illumination system is malfunctioning, the warning lamp illuminates.

25.0°

Temperature indicator: displays the ambient temperature.



Electric parking brake indicator lamp: when the electric parking brake is applied, the indicator lamp illuminates.

READY

Ready indicator lamp: when the vehicle can run normally, the indicator lamp illuminates.



Speed Limiting indicator lamp: when Speed Limiting is in the ready mode, the grey/white indicator lamp illuminates; when Speed Limiting is enabled, the green indicator lamp illuminates; when Speed Limiting is surpassed, the yellow warning lamp illuminates.



Adaptive Cruise Control indicator lamp: when Adaptive Cruise Control is in the ready mode, the grey/white indicator lamp illuminates; when Adaptive Cruise Control is enabled, the green indicator lamp illuminates; when Adaptive Cruise

Control is malfunctioning, the grey warning lamp illuminates.



smart Pilot Assist indicator lamp: when smart Pilot Assist is in the ready mode, the grey/white indicator illuminates; when smart Pilot Assist is enabled, green indicator lamp illuminates; when the steering control is not enabled, the steering wheel portion is in yellow, showing that steering control cannot be provided; when it is malfunctioning, the grey warning lamp illuminates.



Power limited indicator lamp: when the vehicle power is limited, the indicator lamp illuminates.



Anti-lock Brake System fault indicator lamp: if the warning lamp illuminates when the vehicle is powered on or during a journey, Anti-lock Brake System could be malfunctioning. In case of the situations above during normal driving, park the vehicle in a safe area and contact a smart Authorized Service Partner. It could be dangerous to continue driving the vehicle.



Abnormal tyre pressure warning lamp: when the tyre pressure is too low, the warning lamp illuminates, and the relevant warning information is shown on the driver information display. If the active tyre pressure monitoring system is malfunctioning, the indicator lamp flashes for a period of time, and then remains on. Contact a smart Authorized Service Partner for inspection.



Brake system fault indicator lamp: when the system detects that the brake performance decreased and braking

distance extended, the yellow warning lamp illuminates; when the system detects that the brake system is malfunctioning, the red warning lamp illuminates. In case of the situations above during normal driving, immediately park the vehicle in a safe area and contact a smart Authorized Service Partner. It could be dangerous to continue driving the vehicle.



High voltage battery low indicator lamp: when the high voltage battery is low, the indicator lamp illuminates.

s-Pedal

s-Pedal indicator lamp: when the s-Pedal mode is not activated, the grey indicator lamp illuminates; after activation, the blue indicator lamp illuminates.



Electronic Stability Control off/Sport Mode indicator lamp: when Electronic Stability Control is off, the indicator lamp illuminates.



Electronic Stability Control system fault indicator lamp: when Electronic Stability Control is malfunctioning, the warning lamp illuminates. In case of the situations above during normal driving, park the vehicle in a safe area and contact a smart Authorized Service Partner. It could be dangerous to continue driving the vehicle. When Electronic Stability Control intervenes, the warning lamp flashes.



Driver Monitoring System indicator lamp: when level 1/2 fatigue is detected, the red coffee cup lamp flashes; when the sensor or the driver's face is blocked, the yellow indicator lamp illuminates.



Lane Keeping Assist fault indicator lamp: when Lane Keeping Assist is malfunctioning, the warning lamp illuminates.



Lane Keeping Assist or Lane Departure Warning off indicator lamp: when Lane Keeping Assist or Lane Departure Warning is disabled, the indicator lamp illuminates.



Rear Cross Traffic Alert/Rear Collision Mitigation/Door Opening Warning/Lane Change Assist indicator lamp: when the functions are enabled, the green indicator lamp illuminates; when the functions are malfunctioning, the red warning lamp illuminates.



Hill Descent Control indicator lamp: when Hill Descent Control is in the ready mode, the grey/white indicator lamp illuminates; when Hill Descent Control is activated, the green indicator lamp illuminates; when Hill Descent Control is malfunctioning, the yellow warning lamp illuminates.



Front Collision Mitigation fault warning lamp: when Front Collision Mitigation is malfunctioning, the warning lamp illuminates. In case of the situations above during normal driving, park the vehicle in a safe area and contact a smart Authorized Service Partner. It could be dangerous to continue driving the vehicle.



Forward Collision Warning/Autonomous Emergency Braking Off indicator light: this indicator light comes on when the Forward Collision Warning/

Autonomous Emergency Braking is turned off.



External charging/discharging gun connection warning lamp: when the charging/discharging gun is connected, the warning lamp illuminates.



Seat belt reminder warning lamp: when the system detects that the seat belt is not fastened, the warning lamp illuminates. Fasten seat belt correctly to avoid personal injury in case of accident or emergency braking. If the warning lamp remains on after fastening the seat belt correctly, contact a smart Authorized Service Partner for inspection immediately.



Autohold indicator lamp: when Autohold is enabled, the indicator lamp illuminates.



12 V Battery Low indicator lamp: if the warning lamp illuminates after the vehicle is powered on, the charging system may be malfunctioning. In case of the situations above during normal driving, park the vehicle in a safe area and contact a smart Authorized Service Partner for inspection.



ISA fault indicator lamp: when Intelligent Speed Assist is malfunctioning, the warning lamp illuminates.

Head-up display

Notes on the head-up display

Gently wipe the head-up display projector area with a clean and dry microfibre cloth. If necessary, soak the microfibre cloth slightly.



NOTE

- ▶ Avoid liquid entering the head-up display projector area. It may cause electrical failure.
- ▶ Never place any objects or stickers in the head-up display projector area or windscreen projection area. Otherwise, the head-up display may not work normally.
- ▶ Never touch the head-up display projector or throw sharp edged objects or similar objects to it. Otherwise, the head-up display may be damaged.

- ① The vehicle with head-up display is equipped with a special type of windscreen. The correct type of windscreen must be installed to meet the requirements of image projection.

Overview of the head-up display

Head-up display projects image information on the windscreen in front of the driver.



- ① Head-up display projection area

Head-up display projection area

When the driver assistance system and navigation are not enabled, the head-up display only shows the vehicle speed.

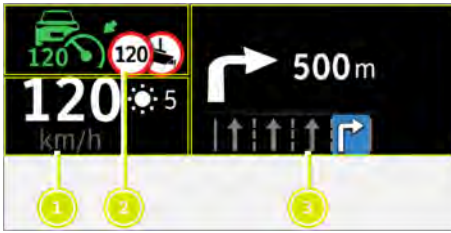

- 1 Display the current vehicle speed
- 2 Display that driver assist is enabled
- 3 Display driver assist and navigation information

When there is a serious warning for the driver assistance system, no other information is displayed on the head-up display.

Enabling/disabling the head-up display

Enter the shortcut interface:

- Swipe downward on the centre display or tap > to turn on/off the head-up display.

Enter the setting interface:

- Tap > *Quick Controls* > to turn on/off the head-up display.
- Tap > *General* > *Display* > *Head-up display* to turn on/off the head-up display.

Enabling/disabling the snow mode

Enter the setting interface:

- Tap > *General* > *Display* > *Snow mode* to turn on/off the snow mode.
- When the snow mode is enabled, the color of information displayed on the head-up display changes, which is convenient to view in the snow environment.

Adjusting the head-up display

⚠ WARNING

- ▶ Before driving, make sure the position and brightness of the image projection of the head-up display do not hinder driving safety. Incorrectly adjusting the image position or brightness may hinder the driver's vision and cause accidents, resulting in personal injury and death.
- ▶ Never keep looking at the image projection of the head-up display during the journey. Otherwise, you may not see pedestrians and objects on the road in front of the vehicle.

! NOTE

- ▶ When you wear polarized sunglasses, you may not see the image projection of the head-up display clearly. Adjust the brightness of head-up display or remove the sunglasses.
- ▶ You can enable/disable the snow mode on the centre display when driving in snow or the road reflection is serious.

Enter the setting interface:

- Tap > *Quick Controls* > *Head-up Display* to enter the adjustment interface.



Brightness and height adjustment

- Brightness adjustment: after the adjustment function is turned on, the adjustment information can be checked on the imaging projected by the head-up display; press and hold / on the right side of the steering wheel to adjust the head-up display brightness.
- Height adjustment: after the adjustment function is turned on, the adjustment information can be checked on the imaging projected by the head-up display; press and hold / on the right side of the steering wheel to adjust the head-up display height.

After adjusting, tap Save to complete the adjustment. If the previous setting is needed, tap Recover.

Angle adjustment

- Angle adjustment: after the adjustment function is turned on, the adjustment information can be checked on the imaging projected by the head-up

display; press and hold  /  on the right side of the steering wheel to adjust the head-up display tilting angle.

After adjusting, tap Save to complete the adjustment. If the previous setting is needed, tap Recover. If readjustment is needed, tap Reset.

Overview and operation

Notes on operating the centre display

⚠ WARNING Risk of interference caused by the centre display

You may be distracted if you operate the integrated information and communication equipment while driving. You could lose control of the vehicle.

- ▶ Note the road and traffic conditions, stop the vehicle safely, and then operate the centre display.

You must comply with local laws and regulations for operating the centre display.

- ⓘ Depending on the model configuration and market, the actual equipment of your vehicle may be different from the descriptions and illustrations. Refer to the actual vehicle.
- ⓘ On right-hand drive vehicles, the layout of centre display is similar to the left-hand drive vehicles, but some interfaces are mirrored. The specific details are subject to the vehicle delivered.

! NOTE Rise of surface temperature due to direct sunlight on the centre display

If the display is exposed to direct sunlight, its surface will become very hot.

- ▶ If the centre display has been exposed to direct sunlight and its surface is dark, pay attention to the temperature of the centre display before touching it.

ⓘ If you wear polarized sunglasses, it may be difficult to read the information on the centre display.

ⓘ Film containing metallic substances could block radio signals. Do not apply film containing metallic substances to the windscreen, otherwise system operation could be affected.

Overview of centre display

When operating the centre display, observe the local laws and regulations.





- 1 Centre display switches.
- 2 Centre display with touch function.
- 3 Centre display switches:

 Press briefly to enter the centre display screen saver, press briefly again to exit the centre display screen saver; press and hold for 8 seconds or more to restart the centre display

 Climate control AUTO switch

 Windscreen maximum defrosting on/off switch

 Hazard warning light on/off switch

 Rear windscreen and outside rearview mirror defrosting on/off switch

 Mode switch

 Turning on/off the quick setting interface

- ⓘ By operating on the centre display, you can control settings such as the multimedia, certain vehicle functions and climate control.

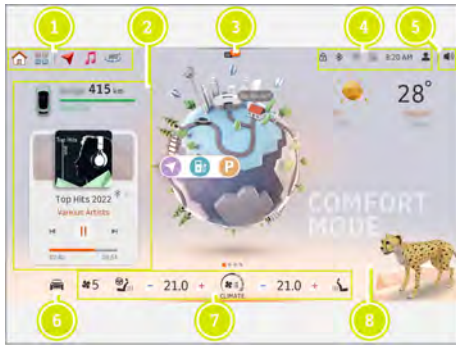

- 1 **Shortcut bar:** tap main interface/ application interface/ navigation (if equipped)/ multimedia/ Park Assist 360 Camera to enter the corresponding function.
- 2 **Custom column:** swipe this area up and down to adjust the display information as needed: display in upper area (multimedia/instantaneous power consumption/call); display in lower area (multimedia/instantaneous power consumption/mileage).
- 3 **Message notification:** swipe downward on the centre display or tap button to enter the shortcut interface to view notification messages.
- 4 **Status bar:** tap this area to enable/disable door lock/ Bluetooth/ WiFi (if equipped)/ network connection signal (if equipped)/ 09:00 time/ personal centre. This area also displays the icon of the vehicle's corresponding function.
- 5 **Volume control:** tap volume control to adjust multimedia/navigation (if equipped)/voice assistant (if equipped)/phone volume.
- 6 **Setting:** tap to enter the setting interface.
- 7 **Climate control bar:** operate the climate control bar to control the corresponding climate control function.

- 8 **Main interface:** the main interface may contain: multimedia/inspiring planet/navigation (if equipped)/air quality/weather (if equipped)/drive mode. Tap the avatar for interaction, and double-tap it to wake up the Voice Assistant.

Task manager: when one or more applications are opened, double tap to enter the task manager, and drag the application upward or tap Delete to release memory.

When the corresponding function of the vehicle is enabled, the status bar displays the following icons:

- Wireless charging
- Air quality
- Hotspot (if equipped)
- USB

Quick Controls interface

Swipe the centre display downward or tap to enter the shortcut interface.

You can swipe up on the shortcut interface depending on the number of functions. The functions on the shortcut interface can be enabled by tapping their icons, and in this interface, a function is enabled/disabled by tapping the relevant function button. When tapped, some functions (triggered) pop up in new windows.

Swipe upward the centre display or tap the blank area of the centre display to go back to the previous interface.

Application interface

Swipe leftward on the centre display or tap to access the application interface, where downloaded applications (third-party applications) and embedded applications can be found, such as Multimedia.

Tap the application to open it, which opens in the subinterface to which it belongs, such as Call.

According to the number of applications, swipe leftward on the centre display in the application interface. For some applications, you can press and hold them, and

then drag them or tap  to delete them.









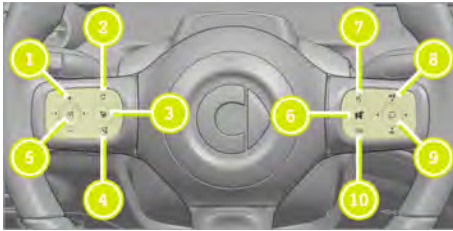







Tap  to go back to the main interface again.

-  The content is for reference only. The specific function name and description should be subject to the real car.

Overview of the steering wheel buttons

When operating the steering wheel buttons, observe the local laws and regulations.



- 1 **Control panel:**
 -  Speed adjustment: press it to increase the speed by an increment of 1km/h (1 mph), press and hold it to increase the speed by an increment of 5 km/h (3 mph); press and hold it to continuously adjust the speed, and release it to stop adjustment.
 -  Speed adjustment: press it to decrease the speed by a decrement of 1 km/h (1 mph), press and hold it to decrease the speed by a decrement of 5 km/h (3 mph); press and hold it to continuously adjust the speed, and release it to stop adjustment.
 -  Function selection.
 -  Function selection.
- 2  Resume function: activate the last selected driver assistance function.
- 3  Automatic Parking Assist.
- 4  Disable function: disable Cruise Control (if equipped)/Adaptive Cruise Control/Speed Limiting/Highway Assist.
- 5  Enable function: enable Cruise Control (if equipped)/Adaptive Cruise Control/Speed Limiting/Highway Assist.
- 6  Mute multimedia.
- 7  Voice control button: press briefly to enable/disable voice input; press and hold to connect CarPlay.
- 8 **Control panel:**
 -  Adjustment button: press briefly to increase the volume, or adjust the head-up display and rearview mirrors; press and hold to adjust continuously, release to stop.
 -  Adjustment button: press briefly to decrease the volume, or adjust the head-up display and rearview mirrors; press and hold to adjust continuously, release to stop.
 -  Adjustment button: press and release this button to reject calls/switch media/select message notifications/switch trip information/adjust the head-up display or rearview mirrors; press and hold this button to adjust the head-up display or rearview mirrors continuously, and release it to stop adjustment.
 -  Adjustment button: press and release this button to answer calls/switch media/select message notifications/switch trip information/adjust the head-up display or rearview mirrors; press and hold this button to adjust the head-up display or rearview mirrors continuously, and release it to stop adjustment.
- 9  Setting button: press briefly to pause or play music/turn off message, confirm selection.
- 10  Trip button: press briefly to display or hide trip information; press and hold to reset trip information.

Shortcut interface

Shortcut interface

⚠ WARNING Risk of interference caused by the centre display

You may be distracted if you operate the integrated information and communication equipment while driving. You could lose control of the vehicle.

► Note the road and traffic conditions, stop the vehicle safely, and then operate the centre display.

① Depending on the model configuration and market, the actual equipment of your vehicle may be different from the descriptions and illustrations. Refer to the actual vehicle.

Enter the Quick Controls interface:

- Swipe downward on the centre display or tap  to enter the Quick Controls interface.

















- ① Function area
- ② Message area
- ③ Mode selection area
- ④ Ambient lighting theme selection area

Function area

Enter the shortcut interface:

- Swipe downward on the centre display or tap  to enter the shortcut interface.

The left side of the shortcut interface is the function area, which allows for the following operations:

- Head-up display: tap  to turn on/off the head-up display.
- Reading light: tap  to turn on/off the reading lights.
- Unfold/fold rearview mirror: tap  to unfold/fold the rearview mirrors.
- Parking sensors: tap  to turn on/off the parking sensors.
- Close all windows: tap  to close all the windows fully.
- Open all windows: tap  to open all the windows fully.
- Ventilate: tap  to open all the windows for ventilation.
- Power Off: tap  to power off the vehicle.
- Wireless charging: tap  to turn on/off the wireless charging function.
- Driver Monitoring System: tap  to turn off the Driver Monitoring System.
- Approach to Unlock: tap  to turn on/off the Approach to Unlock function.
- Screen Cleaning: tap  to turn on/off the Screen Cleaning function.
- Active Sound Control: tap  to turn on/off the Active Sound Control.
- Indirect Life Monitoring: press and hold  to turn off the Indirect Life Monitoring.

Press and hold or tap the icon  to enable the editing function, so the user can customize the icon layout, delete icons, or add icons.

① The content is for reference only. The specific function name and description should be subject to the real car.

Message area

Enter the Quick Controls interface:



- Swipe downward on the centre display or tap  to enter the Quick Controls interface.

The upper right side of the quick controls interface is the message notification area,

where you can view the message content and historical messages. Swipe rightward on the message content, and tap  to delete the message notification.

Mode selection area

Enter the shortcut interface:

- Swipe downward on the centre display or tap  to enter the Quick Controls interface. The middle right of the Quick Controls interface is the mode selection area. Tap  to select the mode.

Entertainment mode

 Entertainment mode: set the parking time, tap On to enable the parking comfort mode, or set the Entertainment mode to normally on.

To exit the Entertainment mode, swipe downward on the centre display or tap  to enter the shortcut interface and then tap Off, or wait for the set time expires, so the entertainment mode will be turned off automatically.

- ⓘ After the parking comfort mode is turned on, the vehicle will continue to consume electricity. The traction battery will automatically turn off when the battery SOC drops to 20%.

After the entertainment mode is enabled, the system will maintain functions such as the climate control and centre display entertainment.

ECO+ mode

 ECO+ mode: tap On to turn on the ECO+ mode.

If you need to disable the ECO+ mode, swipe downward on the centre display or tap  to enter the shortcut interface, and tap Off.

After the ECO+ mode is turned on, the system will turn off the Climate Control, ambient light, seat heating and seat ventilation (if equipped), and set the drive mode to ECO.

Energise mode

 Energise mode: tap On to turn on the Energise mode.

If you need to disable the Energise mode, swipe downward on the centre display or tap  to enter the shortcut interface, and tap Off or wait for 180 seconds.

After the Energise mode is turned on, the system turns on the Climate Control, seat ventilation (if equipped), ambient light and music.

Fatigue driving association: when the driver monitoring system is turned on, it can be associated with the Energise mode.

Rest mode

 Rest mode: tap On to turn on the rest mode.

The user can set the alarm clock as needed. To turn off the rest mode, swipe downward on the centre display or tap  to enter the shortcut interface, and tap Off.

When the rest mode is turned on, the system will set the Climate Control to the AUTO mode, close the windows and turn off the reading light at the same time.

Alarm clock: when the rest mode is turned on, the alarm clock can be set as needed.

Pet mode

 Pet mode: tap On to turn on the Pet mode.

If you need to disable the Pet mode, swipe downward on the centre display or tap  to enter the shortcut interface, and tap Off.

After the Pet mode is turned on, the system will adjust the inside temperature and switch the centre display to the screen saver mode to prevent pets from touching by mistake.

- ⓘ The content is for reference only. The specific function name and description should be subject to the real car.

Car wash mode

 Car wash mode: tap "Car Wash Mode" to select "Automated Wash Mode" or "Hand Wash Mode".

To exit the car wash mode, press and hold the "Long press to exit" button on the

centre display to exit the current car wash mode.

When the automated wash mode is enabled, the charging port cover is automatically locked, the liftgate kick sensing function is disabled synchronously, the front radar alarm sound is shielded, and the A/C is switched to the recirculation mode; when the hand wash mode is enabled, the charging port cover is automatically locked and the liftgate kick sensing function is disabled synchronously.

Valet mode (if equipped)

 Valet mode: tap "Valet Mode" and set the password on the centre display, then the centre display will automatically restart and enter the exclusive valet interface.

If you need to disable the valet mode, swipe down on the centre display or tap  to enter the Quick Controls interface, tap "Valet Mode" and enter the owner's preset password on the centre display to exit the valet mode, or exit the valet mode on the mobile APP.

After the valet mode is enabled, the system will disable Bluetooth, voice control, multimedia and other functions upon startup and exit the current account. The owner can enable the valet mode before lending the vehicle to others to protect the privacy.

Ambient lighting theme selection area

Enter the Quick Controls interface:

- Swipe downward on the centre display or tap  to enter the Quick Controls interface.

The lower right part of the quick controls interface is the ambient light theme selection area, where the user can select the corresponding ambient light theme as needed.

Setting interface



Overview of the setting interface

⚠ WARNING Risk of interference caused by the centre display

You may be distracted if you operate the integrated information and communication equipment while driving. You could lose control of the vehicle.

- ▶ Note the road and traffic conditions, stop the vehicle safely, and then operate the centre display.

Enter the setting interface:

- In the main interface, tap  to enter the setting interface.
- Swipe leftward from the right on the centre display or tap  to enter the application interface, and tap  to enter the setting interface.



1 Function selection area:

- Quick Controls: open/close windows, adjust rearview mirrors and liftgate, etc.
- Ambient light: set interior ambient light.
- Car lights: turn on/off rear fog lights, reading lights, ambient lights, etc.
- General: set sound, alarm tone, date, screen brightness, link, etc.
- Driver assistance: set the driver assistance of the vehicle.
- Vehicle setting: set the drive mode, vehicle control, comfort and other functions.

- Vehicle condition: view the vehicle information, front wiper maintenance mode and tyre condition.
- System: view the vehicle version information, notifications and privacy, language, unit and other functions.
- Privacy: view the privacy policy.

2 Function operation area



Quick controls

⚠ WARNING Risk of interference caused by the centre display





You may be distracted if you operate the integrated information and communication equipment while driving. You could lose control of the vehicle.

- ▶ Note the road and traffic conditions, stop the vehicle safely, and then operate the centre display.













Enter the setting interface:

- In the main interface, tap  to enter the setting interface.
- Swipe leftward from the right on the centre display or tap  to enter the application interface, and tap  to enter the setting interface.

The following operations can be performed on the quick controls interface:

- Energy recovery: the user can select the energy regenerative braking level according to needs.
- Steering wheel assistance: the user can set Automatic, Gentle, Comfortable and Stable as needed.
- Liftgate
 - Opening the liftgate: tap  to open the liftgate.
 - Closing the liftgate: tap  to close the liftgate.
 - Preset the liftgate opening height: tap  to set the liftgate opening height (1, 2, 3, 4, and 5) as required.
- Enabling/disabling the child safety lock: tap the child safety lock , and tap the left child safety lock/right child

safety lock to enable/disable the child safety lock.

- Adjusting the rearview mirror: tap , select Left or Right, and use the buttons , ,  and  on the right side of the steering wheel to make adjustments.
- Adjust the head-up display: tap  to turn on/off the head-up display.
 - Brightness and height adjustment: tap Brightness and Height Adjustment, and use the buttons  and  on the right side of the steering wheel to adjust the brightness, and the buttons  and  to adjust the height.
 - Angle adjustment: tap Angle and use the buttons  and  on the right side of the steering wheel to adjust the angle.
- Adjusting the passenger's seat: tap , select the seat cushion or seat back and make adjustment.



Ambient light

⚠ WARNING Risk of interference caused by the centre display



You may be distracted if you operate the integrated information and communication equipment while driving. You could lose control of the vehicle.

- ▶ Note the road and traffic conditions, stop the vehicle safely, and then operate the centre display.

Enter the setting interface:

- In the main interface, tap  to enter the setting interface.
- Swipe leftward from the right on the centre display or tap  to enter the application interface, and tap  to enter the setting interface.

Ambient light is used to ensure that the interior of the car is not too dark during driving, and also to create a pleasant driving environment.

- Turn on/off ambient light: tap  to turn on/off the ambient light.
- Customize ambient light: tap Custom to customize the colour of ambient light (single, dual, and theme) as desired.
 - ① When the dual-color mode is set and the color interaction function is turned on, the dual-color area of the ambient light interactively changes the light color according to the design.
- Intelligent mode:
 - When Drive Mode is selected, the ambient light will change colour in different drive modes.
- Brightness adjustment: drag the brightness bar to adjust the brightness of the ambient light.
- Ambient light setting: tap  to enter the ambient light setting, and turn on/off the Courtesy Ambient Light, Voice Interaction Ambient Light, Climate Control & Ambient Light Interaction and Range Reminder Ambient Light.





Lights

⚠ WARNING Risk of interference caused by the centre display

You may be distracted if you operate the integrated information and communication equipment while driving. You could lose control of the vehicle.

- ▶ Note the road and traffic conditions, stop the vehicle safely, and then operate the centre display.

Enter the setting interface:

- In the main interface, tap  to enter the setting interface.
- Swipe leftward from the right on the centre display or tap  to enter the application interface, and tap  to enter the setting interface.
- Adaptive front illumination system: tap  to turn on/off the adaptive front illumination system.

- Rear fog lamp: tap  to turn on/off the rear fog lamps.
- Star mode: tap Star Mode to turn on/off the star mode.
- Reading light: tap Reading Light to turn on/off the reading lights.
- Environment light
 - Follow me home: the user can set the headlamp off delay time to Off, 30 s, 60 s, and 90 s according to need.
 - Approach lighting: tap Approach Lighting to turn on/off the approach lighting.
 - Courtesy lighting: tap Courtesy Lighting to turn on/off the courtesy lighting.



General

⚠ WARNING Risk of interference caused by the centre display

You may be distracted if you operate the integrated information and communication equipment while driving. You could lose control of the vehicle.

- ▶ Note the road and traffic conditions, stop the vehicle safely, and then operate the centre display.

Enter the Settings interface:

- In the main interface, tap  to enter the Settings interface.
- Swipe leftward from the right on the centre display or tap  to enter the application interface, and tap  to enter the setting interface.

Sound

Sound effect adjustment: select Beats, Classical, Vocal (if equipped) or Boosted (if equipped).

Treble/alto/bass: tap Treble/Alto/Bass to drag the display bar for adjustment.

Global volume: tap Global Volume to adjust the volume of media, navigation, voice assistant and phone.

Simulated sound (if equipped): select Off, smart Original, Classical, Interstellar or Explore.

Speed based volume adjustment: tap Off, Low, Medium, or High to adjust the volume.

Alert sound volume: tap Off, Low, Medium, or High to adjust the alert sound volume.

Touch tone: tap Touch Tone to turn on/off the touch tone.

Driving mode sound: tap Driving Mode Sound to turn on/off the driving mode sound.

Volume mixer: set to Automatic Mixing or Direct Mixing.

- Automatic mixing: during Navigation And Announcement, the system will reduce the sound of multimedia.
- Direct mixing: when Multimedia, Navigation and Announcement sound at the same time, the system does not carry out any sound reduction.

Display

Avatar: tap the image to select the corresponding avatar.

Static avatar: tap Static Avatar to turn on/off the static avatar.

Day/night mode: tap Auto Brightness, Day, or Night to select the day/night mode.

Theme color: tap Beach Orange, Ocean Blue, Aurora Pink, Flame Red or Space Grey to select the required theme color.

Instrument and key backlight: drag the display bar to adjust the brightness of instruments and key backlight.

Centre display brightness: tap Auto or drag the display bar to adjust the centre display brightness.

Screen quick start-up: tap Screen Quick Start-up to turn on/off the screen quick start-up.

Head-up display: tap Head-up Display to turn on/off the head-up display.

Snow mode: tap Snow Mode to turn on/off the snow mode. The head-up display will turn yellow if the snow mode is turned on.

Instrument display priority: set Navigation Priority or Music Priority.

- When navigation priority is selected, after navigation App is opened on the centre display, the driver information display indicates navigation information; when music priority is selected,

the driver information display indicates music information.

Screen cleaning: tap Screen Cleaning to clean the screen, and press and hold it to exit.

Connection

Wireless charging: tap Wireless Charging to turn on/off the wireless charging.

Bluetooth: tap Bluetooth to turn on/off Bluetooth, set the Bluetooth name, view the connected Bluetooth devices and the Bluetooth devices found by the system, delete Bluetooth devices, and re-select the Bluetooth devices you want to connect.

Wi-Fi (if equipped): tap Wi-Fi to turn on/off Wi-Fi, view the connected networks, the networks found by the system, and re-select the networks you want to connect.

Hotspot (if equipped): tap Hotspot to turn on/off the hotspot, and set the hotspot name, hotspot password, hotspot detailed information, etc.



Driving assistance

⚠ WARNING Risk of interference caused by the centre display

You may be distracted if you operate the integrated information and communication equipment while driving. You could lose control of the vehicle.

- ▶ Note the road and traffic conditions, stop the vehicle safely, and then operate the centre display.

Enter the Settings interface:

- In the main interface, tap  to enter the Settings interface.
- Swipe leftward from the right on the centre display or tap  to enter the application interface, and tap  to enter the setting interface.

Safety

Forward Collision Warning: tap Off, Near Distance, Medium Distance and Far Distance to set the level of Forward Collision Warning.

Rear Collision Mitigation: tap Rear Collision Mitigation to enable/disable Rear Collision Mitigation.

Rear Cross Traffic Alert: tap Rear Cross Traffic Alert to enable/disable Rear Cross Traffic Alert.

Door Opening Warning: tap Door Opening Warning to enable/disable Door Opening Warning.

Lane Departure Warning: tap Off, Vibrate, Beep to set the warning mode.

Lane Keeping Assist: tap Lane Keeping Assist to turn on/off the Lane Keeping Assist.



Parking Emergency Brake: tap Parking Emergency Braking to turn on/off the Parking Emergency Brake.

Assistance

Lane Change Collision Warning Beep: tap Off, Warning Light, Warning Light and Beep to set the warning mode.

Automated Lane Change Assist: tap Automated Lane Change Assist to turn on/off the Automated Lane Change Assist.

Automatic Speed Adjustment: tap Automatic Speed Adjustment to turn on/off the Automatic Speed Adjustment.

Speed Limit Awareness Warning: tap No Alarm, Flash, Flash and Beep to set the warning mode, and tap  and  to set the sensitivity of Speed Warning.

Speed Warning: tap Speed Warning to turn on/off manual setting of speed limit of Speed Warning, and drag the display bar to adjust the speed limit.



Vehicle settings

⚠ WARNING Risk of interference caused by the centre display

You may be distracted if you operate the integrated information and communication equipment while driving. You could lose control of the vehicle.

► Note the road and traffic conditions, stop the vehicle safely, and then operate the centre display.

Enter the setting interface:

- In the main interface, tap  to enter the setting interface.
- Swipe leftward from the right on the centre display or tap  to enter the application interface, and tap  to enter the setting interface.

Driving

Driver Monitoring System: tap Driver Exhaustion Alert to turn on/off.

Steering Wheel Re-centring: tap Steering Wheel Re-centring to turn on/off.

Launch Control: tap Launch Control to turn on/off the Launch Control.

ESC off: tap ESC off to turn on/off Electronic Stability Control.

Towing mode: tap Towing Mode to view the operation steps.

Vehicle control

Find My Car: tap Horn + Flash and Flash Only to set Find My Car.

Easy Entry/Exit: tap Easy Entry/Exit to turn on/off.

Automatic Window Closing when Locking: tap Automatic Window Closing when Locking to turn on/off the Automatic Window Closing when Locking.

Automatic fold exterior mirrors when locking car: tap Automatic Fold Exterior Mirrors When Locking Car to turn on/off.

Angle down driver-side exterior mirror when reversing: tap Angle Down Driver-side Exterior Mirror When Reversing to turn on/off.

Angle down passenger-side exterior mirror when reversing: tap Angle Down Passenger-side Exterior Mirror When Reversing to turn on/off.

When reversing, rear wiper turned off: tap When Reversing, Rear Wiper Turned Off to turn on/off.

Approach to Unlock/Walk Away to Lock: tap Approach to Unlock/Walk Away to Lock to turn on/off.

Double Click Unlock: tap Double Click Unlock to turn on/off.

Touch to Unlock: tap One Side or All Doors to set Touch to Unlock.

Unlock the vehicle at P gear: tap Unlock the Vehicle at P Gear to turn on/off.

Lock sound: tap Lock Sound to turn on/off.

Power Off: tap Power Off to power off the vehicle.

Comfort

Driver seat heating: tap 5 min, 15 min, 30 min and Continued to set the heating time for the driver seat.

Passenger seat heating: tap 5 min, 15 min, 30 min and Continued to set the heating time for the passenger seat.

Driver Seat Ventilation (if equipped): tap 5 Minutes, 15 Minutes, 30 Minutes and Constant to set the ventilation time of the driver's seat.

Passenger Seat Ventilation (if equipped): tap 5 Minutes, 15 Minutes, 30 Minutes and Constant to set the ventilation time of the passenger's seat.



Vehicle condition

⚠ WARNING Risk of interference caused by the centre display

You may be distracted if you operate the integrated information and communication equipment while driving. You could lose control of the vehicle.

- ▶ Note the road and traffic conditions, stop the vehicle safely, and then operate the centre display.

Enter the setting interface:

- In the main interface, tap  to enter the setting interface.
- Swipe leftward from the right on the centre display or tap  to enter the application interface, and tap  to enter the setting interface.

Vehicle information

Vehicle information:

- License plate number: tap License Plate Number to set the license plate number.
- Vehicle identification number (VIN)
- Motor serial number

- Vehicle type

Front wiper maintenance mode: tap Front Wiper Maintenance Mode to enable/disable the front wiper maintenance mode.

Tyre condition

Tap Refresh to check the tyre condition: tyre pressure, tyre temperature.

Maintenance information

To check the maintenance information: remaining mileages and the amount of time and days left until next service.



System

⚠ WARNING Risk of interference caused by the centre display

You may be distracted if you operate the integrated information and communication equipment while driving. You could lose control of the vehicle.

- ▶ Note the road and traffic conditions, stop the vehicle safely, and then operate the centre display.

Enter the Settings interface:

- In the main interface, tap  to enter the Settings interface.
- Swipe leftward from the right on the centre display or tap  to enter the application interface, and tap  to enter the setting interface.

OTA upgrade (if equipped)

The vehicle software can be upgraded remotely and wirelessly to gain new features, bringing better performance and richer features to the vehicle.

Tap Version Information to view the details of the current version information of the vehicle; tap Check for Updates to manually retrieve whether there is a new version; tap Upgrade Now to view the content profile of the updatable software and choose an immediate update or an appointed upgrade of the software.

If the network is abnormal or the network connection is not smooth, tap Network Reset to update the network. If the network

is still abnormal, please contact a smart Authorized Service Partner.

Factory Reset: tap Factory Reset to restore the system to the factory default settings.

! NOTE

- ▶ Do not perform OTA upgrade in places that affect traffic.
- ▶ Do not perform OTA upgrade in places with poor network signal.
- ▶ The vehicle cannot be operated during OTA upgrade. Please take articles you need out of the vehicle before OTA upgrade.
- ▶ If the vehicle is unlocked at the end of the countdown, the OTA upgrade cannot be performed. Please re-execute the OTA update process.
- ▶ During the OTA upgrade of the vehicle, if the prompt of upgrade failure or update delay pops up on the centre display, please check whether the vehicle meets the OTA upgrade conditions before re-performing the OTA upgrade operation. If the vehicle still cannot be upgraded, contact a smart Authorized Service Partner.

Notifications and Privacy

Notification Push: tap Notification Push to turn on/off the Notification Push.

Prompt Type: tap Mute, Ring, Broadcast, Ring & Broadcast to set the prompt type.

Avatar Voice Broadcast: tap Avatar Voice Broadcast to turn on/off the Avatar Voice Broadcast.

Vehicle location: tap Vehicle Location to turn on/off the vehicle location information.

- i** The system is off by default, and some functions on the mobile APP will no longer display the location of the vehicle. When this function is enabled, you can choose one year or the current driving. After the end of one year or the current driving, the system will automatically return to the off state.

Permission Management: tap Permission Management to set the APP permissions.

Language and Unit

Language: Set the language of the centre display.

Time Zone: Set the time zone displayed on the centre display.

Temperature: Set the temperature unit to °C or °F.

Speed: Set the unit of vehicle speed to km/h or mph.

Tyre pressure: Set the unit of tyre pressure to bar, kPa, or psi.

Time format: Set the time format displayed on the centre display to 24-hour or 12-hour.



Privacy settings

⚠ WARNING Risk of interference caused by the centre display

You may be distracted if you operate the integrated information and communication equipment while driving. You could lose control of the vehicle.

- ▶ Note the road and traffic conditions, stop the vehicle safely, and then operate the centre display.

Enter the setting interface:

- In the main interface, tap  to enter the setting interface.
- Swipe leftward from the right on the centre display or tap  to enter the application interface, and tap  to enter the setting interface.

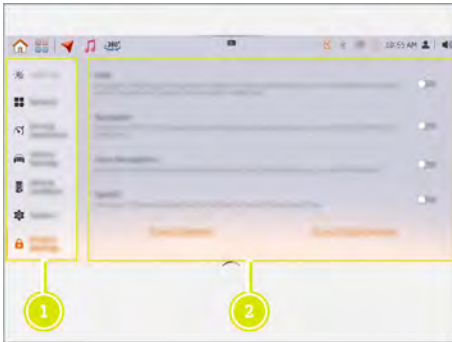

- 1 Function selection area
- 2 Function operation area

Users can set whether to allow the collection of vehicle-related information as needed. For details, please refer to the privacy policy on the centre display.

Energy management



Overview of the energy management

⚠ WARNING Risk of interference caused by the centre display

You may be distracted if you operate the integrated information and communication equipment while driving. You could lose control of the vehicle.

- ▶ Note the road and traffic conditions, stop the vehicle safely, and then operate the centre display.

Enter the energy management interface:

- Swipe leftward from the right on the centre display or tap  to enter the application interface, and tap  to enter the energy management interface.



- 1 Function selection area:
 - Charging
 - Discharging
 - This trip
 - Trip
- 2 Function operation area



Charging and discharging

⚠ WARNING Risk of interference caused by the centre display

You may be distracted if you operate the integrated information and communication equipment while driving. You could lose control of the vehicle.

- ▶ Note the road and traffic conditions, stop the vehicle safely, and then operate the centre display.

Enter the energy management interface:

- Swipe leftward from the right on the centre display or tap  to enter the application interface, and tap  to enter the energy management interface.

Charging

Routine mode: choose Routine Mode as needed.

Long distance mode: choose Long Distance Mode as needed.

Charging reservation: tap "Schedule Charging Time Setting" to enter the charging schedule interface. The user can set the charging start and end time as needed,

and tap "Save". If the "Charging ends after reaching target SOC" switch is turned on, the charging process will not end when it is the end time of the charging schedule and the high voltage battery is not charged to the target SOC. In this case, the charging process will continue to reach the target SOC before ending.

Temperature adjustment before charging: when this switch is turned on, the system immediately adjusts the temperature of the high voltage battery to increase the charging speed. This function is recommended before DC charging.

- ① This function needs different duration to adjust the temperature of the high voltage battery depending on the ambient temperature. When the high voltage battery reaches the optimal temperature, this function will be turned off automatically. In the temperature adjustment process of the high voltage battery, a small amount of electricity will be consumed.

Charging reservation: after this function is enabled, the vehicle will turn on the battery temperature adjustment and cab temperature control functions in advance according to the set travel time.

AC charging current: set the AC charging current.

Range: tap Standard and Dynamic to view the range.

- ① The remaining range on the driver information display is merely an estimate, and it may not account for factors such as driving styles and environmental conditions.

Discharging

Swipe on the dotted line on the car model and select the target SOC when the Vehicle to Load stops.

Discharge: tap Discharge to turn on the discharging function.

Discharging record: tap Discharging to view the discharging record.



Trip B

⚠ WARNING Risk of interference caused by the centre display

You may be distracted if you operate the integrated information and communication equipment while driving. You could lose control of the vehicle.

- ▶ Note the road and traffic conditions, stop the vehicle safely, and then operate the centre display.

Enter the energy management interface:

- Swipe leftward from the right on the centre display or tap  to enter the application interface, and tap  to enter the energy management interface.

You can view the reset method, recent trip record, energy distribution and range of current trip.

- ① The remaining range on the driver information display is merely an estimate, and it may not account for factors such as driving styles and environmental conditions.



Trip

⚠ WARNING Risk of interference caused by the centre display

You may be distracted if you operate the integrated information and communication equipment while driving. You could lose control of the vehicle.

- ▶ Note the road and traffic conditions, stop the vehicle safely, and then operate the centre display.

Enter the energy management interface:

- Swipe leftward from the right on the centre display or tap  to enter the application interface, and tap  to enter the energy management interface.

Trip information: you can view the trip information, and click Reset to reset the trip information.

Energy distribution: You can view the energy distribution.

Range: you can view the Range.

- ① The remaining range on the driver information display is merely an estimate, and it may not account for factors such as driving styles and environmental conditions.

Navigation and traffic

Navigation(if equipped)



- ⚠ WARNING** Risk of interference caused by the centre display

You may be distracted if you operate the integrated information and communication equipment while driving. You could lose control of the vehicle.

- ▶ Note the road and traffic conditions, stop the vehicle safely, and then operate the centre display.

- ① Film containing metallic substances could block radio signals. Do not apply film containing metallic substances to the windscreen, otherwise system operation could be affected.

Enter the navigation interface:

- Tap  on the shortcut interface to enter the navigation interface.
- Swipe leftward from the right on the centre display or tap  to enter the application interface, and click on AMAP to enter the navigation interface.

Tap the shortcut icon on the main interface to enter the Navigation interface.

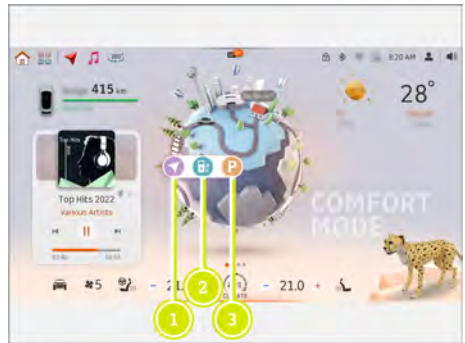

- 1 View navigation history or search for destinations
- 2 Quickly search for charging piles
- 3 Quickly search for parking lots

Navigation split screen

Enter the navigation interface, and swipe rightward from the leftmost on the screen by one finger or two fingers, so a navigation split screen appears. Multimedia and Call are on the left side of the navigation split screen. Tap the folding symbol on the left of the split screen to return to the navigation interface in full screen.

Multimedia

Overview of multimedia



- ⚠ WARNING** Risk of interference caused by the centre display

You may be distracted if you operate the integrated information and communication equipment while driving. You could lose control of the vehicle.

- ▶ Note the road and traffic conditions, stop the vehicle safely, and then operate the centre display.

- ① Film containing metallic substances could block radio signals. Do not apply film containing metallic substances to the windscreen, otherwise system operation could be affected.

Enter the multimedia interface:

- Tap  on the shortcut interface to enter the multimedia interface.
- Swipe leftward from the right on the centre display or tap  to enter the application interface, and tap  to enter the multimedia interface.

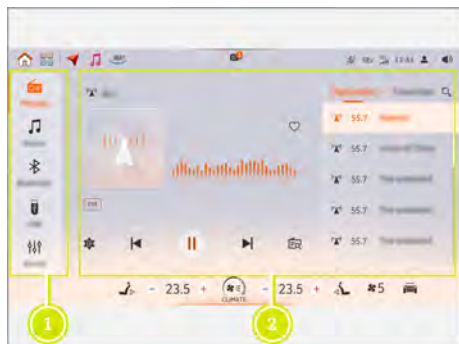

1 Function selection area:

- Local radio
- Online radio
- Bluetooth music
- USB music
- Sound effects

2 Function operation area



Local radio

⚠ WARNING Risk of interference caused by the centre display





You may be distracted if you operate the integrated information and communication equipment while driving. You could lose control of the vehicle.

- ▶ Note the road and traffic conditions, stop the vehicle safely, and then operate the centre display.

Enter the multimedia interface:

- Tap  on the shortcut interface to enter the multimedia interface.
- Swipe leftward from the right on the centre display or tap  to enter the application interface, and tap  to enter the multimedia interface.

The user can perform the following operations in the local radio interface:

- Favorites: users can save their favorite radio stations and delete them by swiping them to the right.
- Radio station list: display the strongest channels from small to large, or swipe down the list to update it.
-  Favorites: select the playing radio station and save it as a favorite radio station.
-  Previous: skip to the previous radio station.
-  Play/Stop: choose to start, stop, or continue play.
-  Next: skip to the next radio station.
-  Search: tap to search for valid stations. Valid stations are stored in the radio list, and the first valid station is played.

- ① To search for radio stations for the first time, it is required to upload the current location information and site list, and the search process may be interrupted by any operation. If the station list is not updated, please use the previous list.



Online radio/Online music

⚠ WARNING Risk of interference caused by the centre display

You may be distracted if you operate the integrated information and communication equipment while driving. You could lose control of the vehicle.

- ▶ Note the road and traffic conditions, stop the vehicle safely, and then operate the centre display.

Enter the multimedia interface:

- Tap  on the shortcut interface to enter the multimedia interface.
- Swipe leftward from the right on the centre display or tap  to enter the application interface, and tap  to enter the multimedia interface.

The user can perform the following operations in the online radio interface:

- View the radio station privacy.
- Favorites: users can save their favorite radio stations and delete them by swiping them to the right.
- Local radio station: display local radio stations.
- National radio station: display national radio stations.
- Favorites: select the playing radio station and save it as a favorite radio station.
- Previous: skip to the previous radio station.
- Play/Stop: choose to start, stop, or continue play.
- Next: skip to the next radio station.
- Search: enter the name to search for a radio station.

The user can log in to the online music following the prompts on the screen. After successful login, the user can enjoy online music.

- In some markets, only online music is provided.

Bluetooth music

⚠ WARNING Risk of interference caused by the centre display

You may be distracted if you operate the integrated information and communication equipment while driving. You could lose control of the vehicle.

- ▶ Note the road and traffic conditions, stop the vehicle safely, and then operate the centre display.

Enter the multimedia interface:

- Tap on the shortcut interface to enter the multimedia interface.
- Swipe leftward from the right on the centre display or tap to enter the application interface, and tap to enter the multimedia interface.

The user can perform the following operations in the Bluetooth music interface:

- Sound effects: classical/standard/rock/jazz/vocal/pop music are optional.
- Play time: adjust by swiping left and right.
- Previous: skip to the previous radio station.
- Play/Stop: choose to start, stop, or continue play.
- Next: skip to the next radio station.
- Bluetooth device connection is required.

USB music

⚠ WARNING Risk of interference caused by the centre display

You may be distracted if you operate the integrated information and communication equipment while driving. You could lose control of the vehicle.



- ▶ Note the road and traffic conditions, stop the vehicle safely, and then operate the centre display.

Enter the multimedia interface:

- Tap on the shortcut interface to enter the multimedia interface.
- Swipe leftward from the right on the centre display or tap to enter the application interface, and tap to enter the multimedia interface.

The user can perform the following operations in the USB music interface:

- Sound effects: classical/standard/rock/jazz/vocal/pop music are optional.
- Play list: display the number of tracks in the list and the play order of the track list. You can swipe up and down to see more information.
- Play mode button: sequential play/single loop/random play can be selected.
- Previous: skip to the previous track.

-  Play/Stop: choose to start, stop, or continue play.
-  Next: skip to the next track.
-  Select a folder to play: you can enter the folder to select a track.
- Play time: adjust by swiping left and right.



Sound effects

⚠ WARNING Risk of interference caused by the centre display

You may be distracted if you operate the integrated information and communication equipment while driving. You could lose control of the vehicle.

- ▶ Note the road and traffic conditions, stop the vehicle safely, and then operate the centre display.

Enter the multimedia interface:

- Tap  on the shortcut interface to enter the multimedia interface.
- Swipe leftward from the right on the centre display or tap  to enter the application interface, and tap  to enter the multimedia interface.

The user can perform the following operations in the sound effects interface:

- Sound effect adjustment: select Beats, Classical, Vocal (if equipped) or Boosted (if equipped).
- Sound field: display the sound field effect inside the vehicle.
- Treble/alto/bass : drag the display bar for adjustment.

smart Companion

Voice control

You can voice control the vehicle functions through the voice assistant. You only need to say your command, and the system will help you complete the operation.

Press the right button  on the steering wheel, or say a wake-up word, such as



"Hello, smart", and wait for the system to issue a prompt sound.

When using voice commands, please pay attention to the following:

- To give a command, speak at a normal speed and in a normal tone.
- Speak clearly and avoid slang.
- When using the voice assistant, keep the cabin quiet.
- To cancel the voice command conversation, press the button  on the right side of the steering wheel again.

Download voice packs (if equipped)

Enter the setting interface:

- Tap  > *System* > *Language and Unit* > , and download voice packs.

Phone



Phone

⚠ WARNING Risk of interference caused by the centre display

You may be distracted if you operate the integrated information and communication equipment while driving. You could lose control of the vehicle.

- ▶ Note the road and traffic conditions, stop the vehicle safely, and then operate the centre display.

When using the phone function, connect a Bluetooth device (→ [Page 150](#)) first.

When there is an incoming call during driving, press the right button  on the steering wheel to answer the call; or press the button  to reject the call, so the main interface will display the information of the incoming call, and you can swipe up the phone interface to hide it in the notification bar.

Enter the phone interface:

- Swipe leftward from the right on the centre display or tap  to enter the application interface, and click Phone to enter the phone interface.

Using phone call

You can perform the following in the phone interface:

- **Recent contacts:** tap Recent Contacts to view the recent received/missed/rejected calls, or directly tap the number to dial.
- **My favorites:** tap My Favorites to quickly call an important contact, or search and delete it.
- **Contacts:** tap Contacts to search for contacts you want to call or delete.
- **Dial:** tap Dial to enter numbers and add contacts.

Personal centre

Personal centre function

⚠ WARNING Risk of interference caused by the centre display

You may be distracted if you operate the integrated information and communication equipment while driving. You could lose control of the vehicle.

- ▶ Note the road and traffic conditions, stop the vehicle safely, and then operate the centre display.

Enter the personal centre interface:

- Tap  in the status bar to enter the personal centre interface.

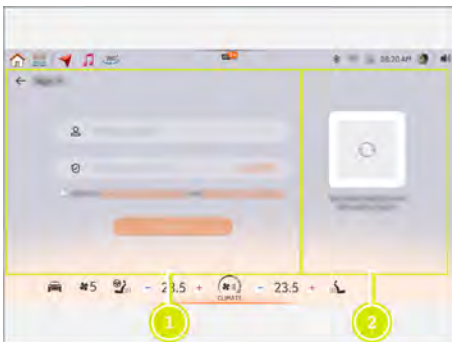

- 1 Log in through the account and password of the mobile phone

- 2 Log in by scanning the QR code with smart APP

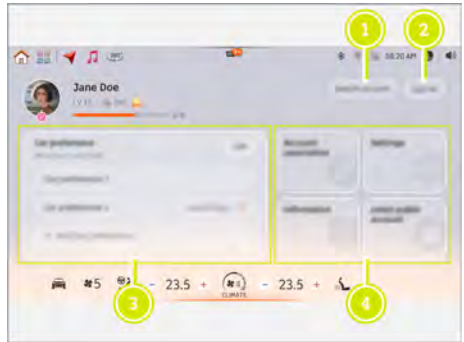

- 1 **Account switch:** tap Account Switch to switch between accounts.
- 2 **Log out:** tap Log Out to log out the personal account.
- 3 **Vehicle preference:** the user can carry out the light setting, basic vehicle setting, display setting and system setting according to preference. After login to the account every time, the vehicle settings will be adjusted according to the account.
- 4 **Function area:** view or set vehicle information through Account Association, Setting, Message, etc.

- i** The content is for reference only. The specific function name and description should be subject to the real car.

Smartphone integration

Android Auto(If equipped)

When the vehicle is equipped with Android Auto, you can use Android Auto to connect your phone to the vehicle and use the navigation, music, phone, message, and other functions on your phone through the centre display of the vehicle.

- ① If your Android phone uses Android 9 or older version, install Android Auto first.

If your Android phone uses Android 10 or later version, it comes with Android Auto and no installation is needed.

Download Android Auto from Google Play Store, and you can view the supported regions, compatible devices, APPs and more information of Android Auto on the support page of Android Auto.

- ① If your Android phone uses Android 9 or older version, install Android Auto first.

If your Android phone uses Android 10 or later version, it comes with Android Auto and no installation is needed.

Wireless pairing

1. Use one of the following to connect the Android phone to the vehicle through Bluetooth.
 - Tap the smart phone icon on the upper left corner of the centre display, the screen automatically leads to the connectivity interface in General, and tap New Device.
 - Tap the Bluetooth icon  on the upper right corner of the centre display, tap Device Preference, the screen automatically leads to the Connectivity interface in General, and tap New Device.
 - Enter the setting interface, tap General, select Connectivity, and tap New Device.
 - Enter the Bluetooth interface on the Android phone and choose to connect a new device. Select smart on the list, and after the new device interface on the centre display is triggered automatically, operate the Android phone to connect.
 - Press and hold the voice control button on the steering wheel, the centre display automatically leads to the device list, and select the

corresponding Android phone to start connection.

2. Enter the PIN code displayed on the centre display on the Android phone.
3. After the device is connected, confirm connection on the connection confirmation page popped out.

Wired pairing

1. Connect the Android phone to the USB data port in the storage area below the vehicle centre display with an USB data cable, the Android phone will connect automatically. After successfully connected, the Android Auto icon  is displayed on the upper left corner on the centre display.
2. Tap the Android Auto icon on the application interface of the centre display to enter Android Auto.

- ① For the best user experience, it is recommended to use the USB data cable provided by the device manufacturer. Aftermarket or third party cables may not work. To maintain the quality of connection, replace the data cable if there is a sign of significant wear.

Operating Android Auto

After the connection is established between the phone and the vehicle, Android Auto can be operated through the centre display, the phone, and the voice control button on the steering wheel.

The vehicle supports the Google voice assistance function. Press the voice control button or say Hey Google, wait for the system to respond, and you can operate the applications of the phone by sending voice commands through the voice assistance.

When using Android Auto, to operate the built-in applications of the centre display, tap the smart icon on the Android Auto interface, or swipe downward from the top/ swipe upward from the bottom to access the vehicle control interface.

To disable Android Auto, tap the Android Auto icon  of the corresponding device in the Bluetooth device list to

disconnect the Android Auto connection, or the smart phone icon  to disconnect the Bluetooth connection.

- ① When using navigation through the smart phone integration, the navigation information is only displayed on the centre display. The built-in navigation in the centre display will exit if it is currently on.
- ① While 2 devices can be connected to the vehicle simultaneously, only 1 of them is allowed for smart phone integration.
- ① Once Android Auto is connected, you cannot directly use the phone and multimedia functions on your device, and can only operate through Android Auto. To use the phone or multimedia functions, you need to disconnect the Android Auto first, and then tap the phone or multimedia icon to operate via Bluetooth.

Apple CarPlay (if equipped)

When the vehicle is equipped with Apple CarPlay, you can use Apple CarPlay to connect your phone to the vehicle and use the navigation, music, phone, message, and other functions on your phone through the centre display of the vehicle.

NOTE

Apple CarPlay may collect and use the vehicle data, such as the speed and location.

smart is not responsible for any use of data by Apple CarPlay.

Apple CarPlay is the service provided by Apple on the basis of its user terms and conditions. Therefore, smart is not responsible for any of the functions and applications of Apple CarPlay.

For information on which applications or which iOS devices that CarPlay supports, visit the official Apple website.

Wireless pairing

1. Use one of the following to connect the iPhone to the vehicle through Bluetooth.
 - Tap the smart phone icon on the upper left corner of the centre display, the screen automatically leads to the connectivity interface in General, and tap New Device.
 - Tap the Bluetooth icon  on the upper right corner of the centre display, tap Device Preference, the screen automatically leads to the Connectivity interface in General, and tap New Device.
 - Enter the setting interface, tap General, select Connectivity, and tap New Device.
 - Enter the Bluetooth interface on the iPhone and choose to connect a new device. Select smart on the list, and after the new device interface on the centre display is triggered automatically, operate the iPhone to connect.
 - Press and hold the voice control button on the steering wheel, the centre display automatically leads to the device list, and select the corresponding iPhone to start connection.
2. Enter the PIN code displayed on the centre display on the iPhone.
3. After the device is connected, confirm connection on the connection confirmation page popped out.

Wired pairing

1. Connect the iPhone to the USB data port in the storage area below the vehicle centre display with an USB data cable, the iPhone will connect automatically. After successfully connected, the Apple CarPlay icon  is displayed on the upper left corner on the centre display.
2. Tap the Apple CarPlay icon on the application interface of the centre display to enter Apple CarPlay.



- ① For the best user experience, it is recommended to use the USB data cable provided by the device manufacturer. Aftermarket or third party cables may not work. To maintain the quality of connection, replace the data cable if there is a sign of significant wear.

Operating Apple CarPlay

After the connection is established between the phone and the vehicle, Apple CarPlay can be operated through the centre display, the phone, and the voice control button on the steering wheel.

The vehicle supports operating Apple CarPlay by voice control through Siri. Press the voice control button or say Hey Siri, wait for the system to respond, and you can operate the applications of the phone by sending voice commands through the voice assistance.

When using Apple CarPlay, to operate the built-in applications of the centre display, tap the smart icon on the Apple CarPlay interface, or swipe downward from the top/ swipe upward from the bottom to access the vehicle control interface.

To disable Apple CarPlay, tap the Apple CarPlay icon  of the corresponding device in the Bluetooth device list to disconnect the Apple CarPlay connection, or the smart phone icon  to disconnect the Bluetooth connection.

- ① When using navigation through the smart phone integration, the navigation information is only displayed on the centre display. The built-in navigation in the centre display will exit if it is currently on.
- ① While 2 devices can be connected to the vehicle simultaneously, only 1 of them is allowed for smart phone integration.
- ① Once Apple CarPlay is connected, you cannot directly use the phone and multimedia functions on your device, and can only operate through Apple CarPlay. To use the phone or multimedia functions, you need to disconnect the Apple CarPlay first, and then tap the phone or multimedia icon to operate via Bluetooth.

Emergency equipment

Using a safety vest

The safety vest is placed in the front passenger side glove box.



1. **To remove:** open the glove box **1** and take out the safety vest bag **2**.
2. Open the bag **2** and take out the safety vest.

Use the safety vest according to the label on the vest.

The safety vest must be replaced in the following cases:

- Reflective strips are damaged or dirty.
- The maximum number of washes is exceeded.
- The fluorescence has faded.

Warning triangle

Taking out the warning triangle

1. Open the boot floor cover.



2. Take out the warning triangle **1**.

Setting up the warning triangle



1. Fold the side reflector **1** up to form a triangle and snap on its top with the upper clip **2**.
2. Spread the base **3** and lay it flat.
Place the warning triangle 50–100 meters behind the vehicle on a conventional road. Place it 150 meters behind the vehicle on an expressway or more than 200 meters in case of rain or fog.

Fire extinguisher fitting point

The vehicle is equipped with a fire extinguisher fitting point, consult a smart Authorized Service Partner for details.

Fire extinguisher

If your vehicle is equipped with a fire extinguisher, it will help put out an initial fire. Be sure to follow the operation manual provided by the fire extinguisher manufacturer.

! NOTE

There are many factors that cause vehicle fire. Usually, the fire can be extinguished in time by fire extinguishers in the initial stage. However, if the fire is at the development stage or fierce stage, it can no longer be put out by fire extinguishers. In this case, it is necessary to evacuate in time and call the fire service.

- i** If you need to install a fire extinguisher fixing bracket and fire extinguisher, consult a smart Authorized Service Partner.

Flat tyre

Stowage location of the tyre repair kit

The tyre repair kit is located in the front luggage compartment.

Open the bonnet (→ Page 178).

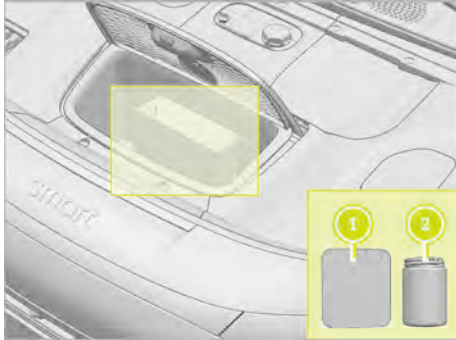

- 1 Electric pump
- 2 Tyre cement bottle

Tyre repair kit

Information on the tyre repair kit:

- When the outside temperature is not below $-20\text{ }^{\circ}\text{C}$ and the puncture hole of the tyre is not larger than 6 mm, tyre sealant can be used.
- Do not remove any foreign objects pierced the tyre.
- Attach the speed limit label to the instrument panel within the driver's vision.

⚠ WARNING Risk of accident when using the tyre sealant

The sealant cannot seal the tyre in the following situations:

- The cut or puncture in the tyre is larger than 6 millimeters.
- The rim is damaged.
- You have been driving under extremely low tyre pressure or with flat tyres.
 - ▶ Do not continue driving.
 - ▶ Consult a smart Authorized Service Partner.

⚠ WARNING Risk of accident and poisoning from tyre sealant

Tyre sealant is hazardous to health and causes irritation. Do not allow it to reach your skin, eyes or clothing. Never swallow it. Do not inhale any sealant vapour. Keep it out of the reach of children.

Observe the following if you come into contact with the tyre sealant:

- ▶ Change out of clothes that are stained with tyre sealant immediately.
- ▶ Rinse off the tyre sealant from your skin with water immediately.
- ▶ Rinse eyes thoroughly with plenty of clean water immediately if tyre sealant gets in eyes. Seek medical attention immediately.
- ▶ If swallowed by mistake, thoroughly rinse your mouth immediately and drink plenty of water. Seek medical attention immediately.
- ▶ In case of allergic reaction, seek medical attention immediately.

NOTE

The electric air pump overheats after extensive operation.

- ▶ Do not keep the pump running continuously for more than 10 minutes.

Refer to the operation instructions for how to use and date of expiration on the tyre repair kit. Contact a smart Authorized Service Partner if any problem occurs during operation.

Jump start the vehicle

Notes on jump start

For jump start, pay attention to the following:

- Never touch the high voltage components in the front compartment.

- Use a battery with rated voltage of 12 V for jumping start the vehicle with low battery.
- Never smoke or use open flame near the 12 V battery.
- When connecting the jumper cable, avoid short circuit with other components in the front compartment.
- The 12 V battery will produce flammable and explosive gases. Improper use of jumper cables may cause sparks and explosions.
- The 12 V battery contains sulfuric acid. If it splashes on eyes, skin or clothes, wash it with plenty of water. If it splashes into eyes, seek medical attention immediately.
- Wash your hands after operating the 12 V battery. The 12 V battery and related accessories contain toxic substances, like lead.

! **NOTE** Risk of vehicle damage from incorrect jumper cable operation

- ▶ If the jumper cables are connected or removed in the wrong order, an electrical short circuit may occur and damage the vehicle. The resulting repairs are not covered by the warranty. The jumper cables must be connected or removed in the correct order, and make sure that the cables do not touch each other or other metals.

If the vehicle cannot be started due to 12 V battery power loss, jump start can be used.

Vehicle jump start

Connecting the jump start cable

1. Open the bonnet (→ Page 178).



2. Remove the 12 V battery cover 1.



3. Open the battery positive terminal cover 1.

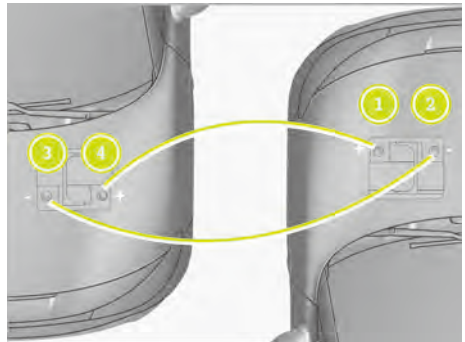

4. Connect the red jumper cable to the 12 V battery positive terminal 4 of the rescue vehicle.
5. Connect the other end of the red jumper cable to the 12 V battery positive terminal 1 of the vehicle with low battery.
6. Connect the black jumper cable to the 12 V battery negative terminal 3 of the rescue vehicle.
7. Connect the other end of the black jumper cable to the 12 V battery negative terminal 2 of the vehicle with low battery.

- Start the rescue vehicle first and then the vehicle to be rescued.

Removing jump start cables

- Remove the black jumper cable **2** from the negative terminal of the vehicle with low battery, and then remove the black jumper cable **3** from the negative terminal of the rescue vehicle.
- Remove the red jumper cable **1** from the positive terminal of the vehicle with low battery, and then remove the red jumper cable **4** from the positive terminal of the rescue vehicle.

Vehicle transportation

Vehicle transportation methods

- i** The towing mode must be activated for vehicle transportation.

⚠ WARNING Risk of accident due to transporting vehicle incorrectly

Avoid the following when transporting the vehicle:

- Tyres being rotated when transporting the vehicle.
- Fastening device contacting the vehicle electrical wiring or fluid lines when tying down the wheels.
- Moving the vehicle when the fastening device is not released.
- ▶ Fasten, transport and move the vehicle in the correct way.

smart is not responsible for the vehicle damage caused by incorrect operation during transportation.

i NOTE

Never transport the vehicle in the way not specified by smart. Observe the following instructions, damage caused by inappropriate vehicle transportation is not covered by smart warranty.

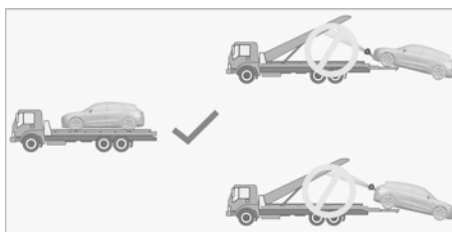

When the wheels rotate, the front and rear E-motors of the vehicle can generate electric energy. It is recommended to transport the vehicle with flatbed trailers or similar transport vehicles. As shown in the figure above, make sure that the tyres cannot move during transportation.

Flatbed trailers transport vehicles are approved vehicle transportation methods.

- i** **smart is not responsible and will not reimburse the cost of any service not dispatched through smart Roadside Assistance.**

- i** During the transfer of the vehicle onto the flatbed trailer by means of a winch or moving out of the parking space for aligning with the flatbed trailer, the tyres are allowed to rotate slowly within 10 meters only after the towing mode is enabled.

- i** If the towing mode cannot be activated or the centre display cannot be accessed, the vehicle can be loaded to the approved transporter using tow brackets/small wheels/assist wheels. Be sure to check the manufacturer's specifications and recommended load capacity before using tow brackets/small wheels/assist wheels.

Towing mode

Activating the towing mode

- Make sure the keyfob is in the vehicle.
- Open and close the driver's door once.
- Press and hold the hazard warning light switch for over 7 seconds until the warning lamps on the driver information display self-diagnoses.

4. Shift to neutral **N** and release the electric parking brake.
5. In case of warning messages, press the button on the right of the steering wheel to clear the warning messages on the driver information display.
 - ⓘ The electric parking brake does not automatically engage under the towing mode. Be aware of risk of vehicle rolling away.
 - ⓘ If the towing mode cannot be activated or the centre display cannot be accessed, the vehicle can be loaded to the approved transporter using tow brackets/small wheels/assist wheels. Be sure to check the manufacturer's specifications and recommended load capacity before using tow brackets/small wheels/assist wheels.

Deactivating the towing mode

The towing mode is deactivated when one of the following conditions is met:

1. The vehicle is shifted to park **P** and locked from outside.
2. The vehicle is shifted to drive **D** or reverse **R**.

Fitting the tow bar

Fitting the front tow bar

1. Open the bonnet (→ Page 178).



2. Pull the front luggage compartment cover handle **1** upward to open the cover.

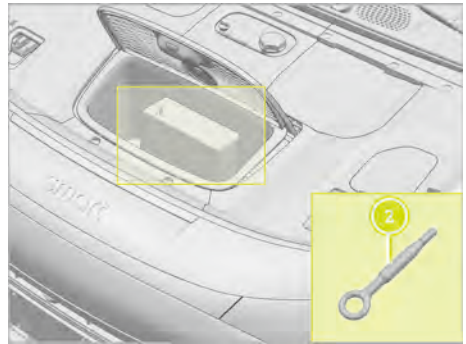

3. Take out the tow bar **2** from the tool kit in the front luggage compartment.



4. Remove the front tow bar cover **3**.



5. Screw the tow bar **4** in and tighten it.
6. After use, return the tow bar and front tow bar cover to their original positions.

Fitting the rear tow bar

1. Open the bonnet (→ Page 178).
2. Open the front luggage compartment cover.
3. Take out the tow bar from the tool kit in the front luggage compartment.

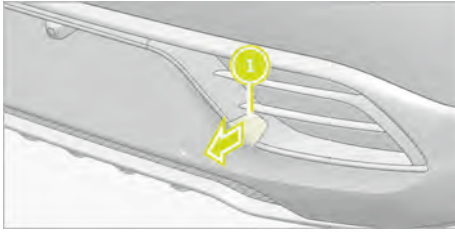

4. Use a suitable tool to remove the rear tow bar cover **1**.

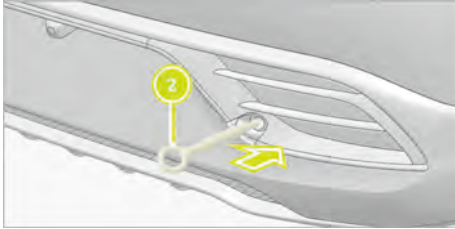

5. Screw the tow bar **2** in and tighten it.
6. After use, return the tow bar and rear tow bar cover to their original positions.

! NOTE

When towing the vehicle, pay attention to the vehicle location and ground clearance. Steep trailer ramp or insufficient ground clearance may cause vehicle damage when towing with the tow bar.

Notes on the wheels and tyres

Notes on noise or abnormal handling

When driving, be aware of vibration, noise, and handling abnormalities, such as vehicle veering, which may indicate damaged wheels or tyres. If you suspect a tyre failure, slow down immediately, come to a safe stop as soon as possible, and inspect the wheels and tyres for damage. Hidden tyre damage could also lead to unusual handling characteristics. If you see no signs of damage, have your wheels and tyres checked at a smart Authorized Service Partner.

Notes on regularly inspecting the wheels and tyres

▲ WARNING Risk of accident due to damaged tyres

Damaged tyres can cause tyre pressure loss.

As a result, you could lose control of your vehicle.

- ▶ Check the tyres regularly for signs of damage and replace any damaged tyres immediately.

Inspect the tyre condition regularly. It is recommended to have the tyres inspected every month or before each special situation, such as a long trip, a vehicle payload change or driving off road.

- Check the tyre pressure.
- Visually check the wheels and tyres for damage.
- Check the valve stem caps.
- Visually check the tyre tread depth and the tyre tread over the entire width. Sufficient tread depth is vital for tyre performance. Tyres with tread depth under 3 mm are more likely to slip on wet surface and not suitable for use. Tyres with tread depth under 4 millimeters have reduced performance in mud and snow and are not suitable for winter driving. When the tread depth is below 1.6 millimeters, wear indicators appear on the

tread surface and the tyre shall be replaced.

Notes on snow chains

Snow chains should only be used on snowy or icy roads or when the local laws and regulations require it, and the vehicle speed should not exceed 40 km/h(25 mph) or the manufacturer's limit, whichever is lower.

When entering a snow free or ice free road section, the snow chains should be removed immediately.

⚠ WARNING Possible risks caused by installing snow chains

Observe particularly the following requirements when using snow chains:

- ▶ Before installing snow chains, please remove the wheel inserts (if equipped).
- ▶ Do not deflate the tyres to install snow chains. Reinflating the tyres could over-tighten the snow chains and cause tyre damage.
- ▶ Snow chains can only be installed on the rear wheels.
- ▶ During driving the vehicle with snow chains, avoid sharp turns and emergency braking.
- ▶ For vehicles equipped with driver assistance systems, do not use driver assistance systems when snow chains have been installed.
- ▶ When using snow chains, please abide by local laws and regulations.
- ▶ Follow the installation instructions specified by the chain manufacturer.
- ▶ Use quality snow chains that meet the designed requirements of tyre and rim dimensions of this model.
- ▶ For uncertainties in the use of snow chains, consult a smart Authorized Service Partner.
- ▶ This vehicle is not equipped with snow chains. Purchase snow chains by yourself for use. Damage to the vehicle or accidents due to incorrect use of snow chains is not covered by warranty.

Applicable snow chain models

Tyre size	Snow chain model
245/45 R19	XG -12 Pro 245
245/40 R20	XG -12 Pro 245

Tyre pressure

Notes on tyre pressure

⚠ WARNING Risk of accident due to insufficient or excessive tyre pressure

Insufficient or excessive tyre pressure pose the following risks:

- The tyres may burst and their service lives are shortened as a result, especially as the payload and vehicle speed increase.
- Driving comfort can be compromised.
- Damage may occur when driving on rugged road.
- The tyre traction can be impaired.
- The tyres may wear excessively and/or unevenly.
- The handling and braking performance can be adversely affected.
- Tyres can overheat and deform.
- Vehicle's operational range can be reduced.
- ▶ Maintain the tyre pressure at a normal level.

⚠ WARNING Risk of accident due to repeated tyre pressure drop

If the tyre pressure drops repeatedly, the wheel, valve or tyre may be damaged.

This may also cause the tyres to burst.

- ▶ Inspect the tyre for signs of foreign objects.
- ▶ Check whether the wheel or valve has a leak.
- ▶ If you are unable to rectify the fault, contact a smart Authorized Service Partner.

⚠ WARNING Risk of accident due to driving with flat tyres

Flat tyres have a significant impact on driving, steering and braking performance.

- ▶ Never drive with flat tyres.
- ▶ Use tyre sealant or contact a smart Authorized Service Partner.

Tyre pressure table

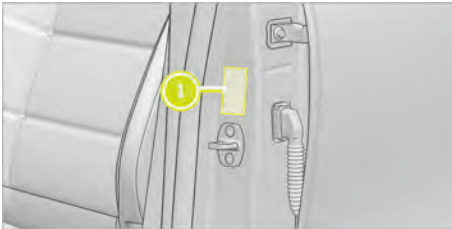

The tyre pressure table is located on the left B pillar **1**.

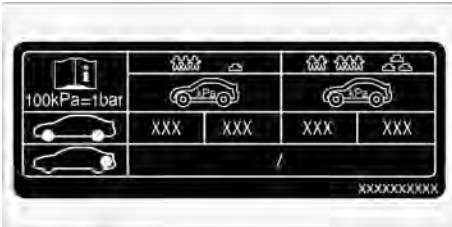

The tyre pressure table shows the recommended tyre pressures approved for all tyres. The recommended tyre pressures are suitable for cold tyres under various driving conditions such as load and/or speed.

Observe the notes on the tyre pressure (→ Page 172).

Tyre pressure monitoring system

⚠ WARNING Importance of tyre pressure abnormal indicator light

- ▶ The tyre pressure monitoring system is not a substitute for proper tyre maintenance. It is always your responsibility to ensure that the tyre pressure meets the value specified by the manufacturer.
- ▶ Driving with low tyre pressure may cause tyre damage and affect the vehicle performance and tread life, and may affect the steering and braking capabilities of the vehicle. If the tyre is seriously damaged, it may also lead to traffic accidents and even serious casualties.

Your vehicle is equipped with an active tyre pressure monitoring system which monitors tyre pressure through sensors fitted on the wheel air valve.

Enter the setting interface:

- Tap > *Vehicle Condition* > *Tyre Condition*, and tap Refresh to check the tyre pressure.

Tyre temperature high, tyre leakage, sensor battery low alarm

When the tyre temperature is high, the tyre leaks, or the sensor battery low alarm is activated, the corresponding tyre starts to flash, accompanied by an audio alarm, and a message pops up on the driver information display.

Tyre pressure low alarm

The standard tyre pressure of your vehicle is 250 kPa. If the tyre pressure drops 50 kPa below the standard, the low-pressure alarm is activated and the corresponding tyre indicator starts to flash. The tyre pressure monitoring system status indicator will remain illuminated until the alarm is removed, accompanied by an audible alarm, and a message will appear on the driver information display. During the cold inflation process, the tyre pressure alarm information will not disappear immediately. Please inflate the tyre to at least 240 kPa,

and then drive at a speed of over 30 km/h for a few minutes to clear the low tyre pressure alarm. For the health of your vehicle's tyres, please pay attention to the tyre pressure and inflate the tyres as needed.

A number of factors can cause a tyre pressure monitoring system to work abnormally:

- Incompatible tyres are installed or wheels are modified.
- There is fluid in the tyre or tyre sealant has been injected.
- Driving with snow chains installed.
- Near TV stations, gas stations, airports and other facilities that generate strong radio waves or electrical noise.
- Accessories that may interfere with the vehicle's radio receiver or electrical system are installed.

! NOTE

- ▶ Check the tyre pressure regularly and make sure it is within the specified range.
- ▶ The tyre pressure monitoring system cannot indicate in advance rapid wear of tyres caused by external factors (such as, tyre burst) nor identify long-term natural uniform pressure losses on all tyres.
- ▶ If the driver information display shows abnormal tyre pressure during driving, park the vehicle in a safe place and contact a smart Authorized Service Partner as soon as possible.

Checking and correcting the tyre pressure manually

Information on the recommended tyre pressure for the vehicle's stock tyres can be found on the tyre pressure table (→ [Page 173](#)) on the driver's side B-pillar.

Always adjust tyre pressure when the tyre is cold, cold tyre conditions:

- The vehicle is driven less than 1.6 kilometers.

- The vehicle is parked away from direct sunlight for at least 3 hours.
- Check the tyre pressure with a suitable tyre pressure gauge.
- If necessary, adjust the tyre pressure.

For vehicles equipped with a tyre pressure monitoring system, you can also check the tyre pressure on the centre display.

Replacing the Wheels and tyres

Notes on replacing the wheels and tyres

For information on permitted wheel/tyre combinations, consult a smart Authorized Service Partner.

⚠ WARNING Risk of accident due to using wheels and tyres of incorrect size

If wheels and tyres of the wrong size are used, the brake or suspension components may become damaged.

- ▶ Please replace wheels and tyres with those that fulfill the specifications of the original parts.

When replacing tyres, make sure the following information is correct:

- ▶ Name
- ▶ Manufacturer
- ▶ Type

⚠ WARNING Risk of injury due to exceeding the specified tyre load-bearing capacity or the permissible speed rating

Exceeding the specified tyre load-bearing capacity or the permissible speed rating may lead to tyre damage and bursting.

- ▶ Use tyres of types and sizes approved by smart for your vehicle. Consult a smart Authorized Service Partner for any question.
- ▶ Observe the tyre load-bearing capacity rating and maximum speed permitted for your vehicle.

NOTE Vehicle or tyre damage from using tyres of an unapproved type and size

Using tyres of an unapproved type and size may adversely affect the handling performance and energy consumption. In addition, other tyre sizes may cause the tyres to come into contact with the body and axle components when under load. This may damage the vehicle or the tyres.

- ▶ For safety reasons, please use tyres, wheels and accessories approved by smart for your vehicle.

WARNING Risk of accident due to driving with retread tyres

smart neither tests nor recommends the use of retread tyres as some existing damage to retread tyres is difficult to detect. Therefore, driving safety cannot be guaranteed.

- ▶ Never use retread tyres.

WARNING Risk of accident due to wheels and tyres being damaged from driving over obstacles

The risk of wheels and tyres being damaged increases when driving over obstacles, which may cause accidents to occur.

- ▶ Proceed with caution and drive slowly when encountering obstacles and potholes, and find an alternative route if possible.

NOTE Damage to tyre pressure sensors from inappropriate use of tyre fitting tools

Vehicles with tyre pressure monitoring system: tyre pressure sensors are installed inside the wheels. Never use a tyre fitting tool in the area of the valve. Otherwise, damage to the tyre pressure sensor may occur.

- ▶ Choose a smart Authorized Service Partner for tyre replacement.

WARNING Risk of accident due to summer tyres being damaged by low ambient temperature

When the ambient temperature is low, driving with summer tyres may cause permanent tyre damage, such as cracks, which may cause accidents to occur.

- ▶ smart recommends the use of 4-season tyres or winter tyres for driving in low temperature or on snowy and icy roads.

Tyres that are not approved for the vehicle by smart or are not being used correctly can impair the operating safety.

Note the following when replacing tyres:

- To replace a tyre, you need to remove the wheel inserts (if equipped) first. For detailed operation, please contact a smart Authorized Service Partner.
- Only use tyres of the same brand, size, load-bearing capacity, speed rating, structure and tread pattern, and the load-bearing capacity of the replacement tyres shall not be lower than the original ones.
- Observe the requirements of wheel dynamic balance.
- Never make any modifications to the brake system, the wheels or the tyres.
- Vehicles with tyre pressure monitoring system: all fitted wheels must come with functioning tyre pressure sensors.

- Break in new tyres at speeds below 80 km/h(50 mph) for the first 100 km(60 miles).
- Ultraviolet rays, extreme temperatures, high load and environmental conditions cause tyres to age over time. It is recommended to replace tyres every six years. Earlier replacement should be considered when necessary, even if the tread depth is above the minimum level.
- The wheel bolts must be tightened to 180 N m. Please check the torque with a torque wrench.

For further information on wheels and tyres, contact a smart Authorized Service Partner.

At the same time, observe following information on other relevant subjects:

- Notes on the tyre pressure (→ Page 172).
- Tyre pressure table (→ Page 173).
- Wheel dynamic balance requirements (→ Page 198).

Notes on rotating the wheels

⚠ WARNING Risk of injury due to rotating wheels

Note the following when rotating wheels:

- ▶ Wheel bolts must be torqued to the correct specification, or accident may occur.
- ▶ After rotating wheels, check and adjust tyre pressure. Incorrect tyre pressure may adversely affect the tyre lifespan and vehicle handling, which could lead to loss of control.

The wear patterns on the front and rear tyres differ:

- Front tyres wear more on the shoulders
- Rear tyres wear more on the centre

Rotate wheels every 5,000 km(3,000 miles) to 8,000 km(5,000 miles) depending on the tread wear. During wheel rotation, make sure that the OUTSIDE indicator on the tyre is pointing outward.

Please consult a smart Authorized Service Partner for the method of wheel rotation.

Notes on storing the wheels

When storing wheels, observe the following notes in particular:

- Store the removed wheels in a cool, dry and preferably dark place.
- Protect the tyres from contact with oil, grease or fuel.

Tyre markings

The tyre markings placed on a tyre sidewall are standardized information used to identify and describe the fundamental characteristics of the tyre.

That information includes the load index, velocity symbol, etc., for example, 245 / 45 R19 102 V.

- 245: nominal section width (mm)
- 45: nominal height ratio
- R: structure type code, R is for radial structure
- 19: nominal rim diameter (in)
- 102: load index
- V: velocity symbol

Tyre wear indicator

Tyre wear indicators are located in the tread grooves of tyres. When the tread of a tyre is at the same height as the wear indicators, please replace the tyre with a new one as soon as possible.

- ① Tyres shall be inspected regularly. If you don't know about the tyre wear indicators inside the tread grooves, please contact a smart Authorized Service Partner.

⚠ WARNING Risk of accident from using tyres of grade lower than the original

- ▶ If a tyre with a load index or speed rating lower than the original one is used, it may overheat and be damaged, thus causing accidents and personal injury.

Seasonal tyres

All season tyres

These tyres are designed to provide adequate traction in all seasons, but may not provide the same traction as winter tyres in icy conditions.

When installing all season tyres, observe the following requirements:

- Use tyres of the same make, size, load index, speed class, construction and tread pattern on all wheel positions.
- Use only radial tyres of the same size and load range as the original tyres.

Summer tyres

Your vehicle's original high performance summer tyres are not suitable for winter road conditions. When driving in low temperature or icy road conditions, winter tyres or all season tyres are recommended. If winter or all season tyres are not installed, contact a smart Authorized Service Partner for advice.

▲ WARNING Accident risk due to improper use of summer tyres

The summer tyres provide insufficient traction in low temperatures or snow and ice road conditions. It is important to select and fit the right tyres for winter to make sure vehicle safety and optimum performance, even if the vehicle is equipped with dual motors.

Winter tyres

Winter tyres improve traction in icy conditions.

When installing winter tyres, observe the following requirements:

- Use tyres of the same make, size, load index, speed class, construction and tread pattern on all wheel positions.
- Use only radial tyres of the same size and load range as the original tyres.

If winter tyres of a lower speed rating are used, do not exceed the tyre's maximum speed rating.



The mountain/snowflake symbol is visible on the sidewall of winter tyres.

Driving the vehicle with winter tyres may experience increased road noise, reduced tread life and reduced traction on dry roads.

Lifting the vehicle

Vehicle lifting points

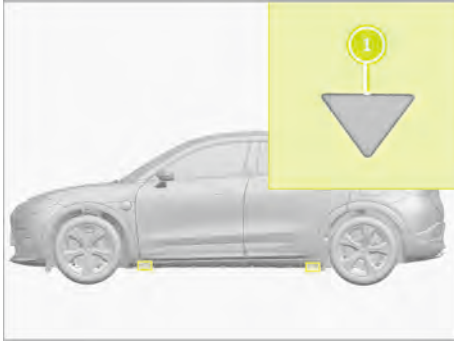

Lifting point indicator **1** under the door sill outer decoration panel.

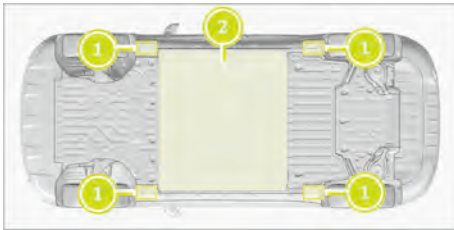

- 1** Vehicle lifting points
- 2** High voltage battery

Notes on lifting the vehicle:

- Never place lift arm pads under the area of the high voltage battery **2**. Only place lift arm pads under the designated lifting points **1** and lifting on any other points may result in vehicle damage. **Damage due to improper lifting is not covered by warranty.**
- Do not lift the vehicle when the charging cable is connected, even if it is not charging at the moment.
- Never work on the vehicle if it is not properly supported. Otherwise, serious damage, personnel injury or death may occur.

Front compartment

Opening and closing the bonnet

⚠ WARNING Risk of accident due to driving with unlocked bonnet

Unlocked bonnet may open and block the vision when driving.

- ▶ Never unlock the bonnet during driving.
- ▶ Make sure that the bonnet is locked before each trip.

⚠ WARNING Risk of accident and injury when opening and closing the bonnet

The bonnet may fall all of a sudden when opening and closing.

It may injure the people within the movement area of the bonnet.

- ▶ Only open or close the bonnet when there is no people within the movement area of the bonnet.

⚠ WARNING Risk of scald when opening the bonnet

If you open the bonnet when the drive system is overheating or fire breaks out in the front compartment, you may come into contact with hot air or spilled liquid.

- ▶ Allow the overheated components to cool down before opening the bonnet.
- ▶ In case of fire in the front compartment, close the bonnet and call the fire department.

⚠ WARNING Risk of injury by moving components

Even if the vehicle is powered off, some components, such as the cooling fan, in the front compartment may keep running or turn on again all of a sudden.

Guarantee the following items before operating in the front compartment:

- ▶ The vehicle is powered off.
- ▶ Never touch the hazardous area around moving components, for example, the cooling fan.
- ▶ Take off jewelry and watch.
- ▶ Keep hair, clothes, and decorations far away from moving components.

⚠ WARNING Risk of injury due to using the front wiper when the bonnet is opened

You may be trapped by the wiper when the bonnet is opened and the front wiper starts moving.

- ▶ Make sure to turn off the wiper and the vehicle before opening the bonnet.

To open:

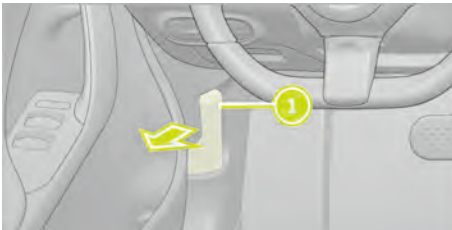

1. Pull the bonnet opening handle **1** under the instrument panel on the driver side twice.
2. Lift up the bonnet.

To close:

1. Lower the bonnet and drop it from about 20 centimeters high.
2. If the bonnet can still be lifted slightly, open the bonnet again and close it with increased force until it can be locked

correctly. Do not press the bonnet down to close it.

- ① Close the bonnet from the middle position. Make sure both sides of the bonnet are fully locked.

Checking the coolant level

⚠ WARNING Risk of accident caused by overheated drive system

If you open the bonnet when the drive system is overheating or fire breaks out in the front compartment, you may come into contact with hot air or spilled liquid.

- ▶ Allow the overheated drive system to cool down before opening the bonnet.
- ▶ In case of fire in the front compartment, close the bonnet and call the fire department.

⚠ WARNING Risk of burn caused by high temperature coolant

The cooling system is pressurized when the drive system is under normal operating temperature. You may be scalded by hot coolant when opening the cap.

- ▶ Allow the drive system to cool down before opening the cap.
- ▶ Wear protective gloves and goggles when opening the cap.
- ▶ Open the cap slowly to release pressure.

1. Park the vehicle on a level ground.
2. Open the bonnet (→ Page 178).

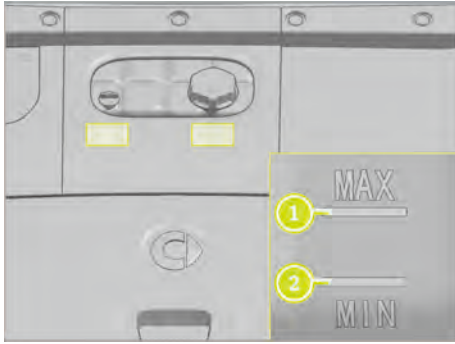

3. If the coolant level is lower than the marked position **2**, inspect or top up coolant at a smart Authorized Service Partner.

Do not fill coolant over the marked position **1**.

Topping up the windscreen washer system

⚠ WARNING Risk of scald caused by hot components in the front compartment

Some components in the front compartment, such as the drive system and radiator, may be very hot.

- ▶ Operate after the front compartment cools down.

⚠ WARNING Risk of accident caused by overheated drive system

If you open the bonnet when the drive system is overheating or fire breaks out in the front compartment, you may come into contact with hot air or spilled liquid.

- ▶ Allow the overheated drive system to cool down before opening the bonnet.
- ▶ In case of fire in the front compartment, close the bonnet and call the fire department.

⚠ WARNING Risk of fire and injury from windscreen washer concentrate

Windscreen washer concentrate is highly flammable.

- ▶ Do not ignite, use naked flame, smoke or cause spark when cleaning with windscreen washer concentrate.

1. Open the bonnet (→ Page 178).



2. Push away the clip **1** and remove the cover along the direction of the arrow.



3. Open the windscreen washer filler cap **2** to top up windscreen washer fluid.

Restore the windscreen washer filler cap and the bonnet to their original position after filling.

Cleaning and care

Notes on cleaning the vehicle

⚠ WARNING Risk of accident caused by reduced braking effect after cleaning the vehicle

The braking effect is reduced after cleaning the vehicle.

- ▶ After cleaning the vehicle, watch out for traffic conditions and brake carefully until the braking effect is fully restored.

! NOTE Damage caused by improper use of car wash

- ▶ Before entering the car wash, make sure the washer is in the right size for the vehicle.
- ▶ Maintain a sufficient ground clearance between the bottom of the vehicle and the guide rails of car wash.
- ▶ Maintain an adequate gap width to the car wash, especially the width of guide rails.

When cleaning your vehicle, first ensure the following to prevent your vehicle from being damaged:

- Make sure the doors, bonnet, liftgate, charging port cover, and all windows are fully closed.
 - The blower motor for ventilation has been turned off.
 - The windscreen wiper switches are in the off position .
 - In car washes with a conveyor system: engage neutral **N**.
- i** In a car wash equipped with a conveyor system, it is recommended not to leave the vehicle after shifting to neutral **N** to prevent the risk of the vehicle rolling away.

Notes on using high pressure car wash

⚠ WARNING Risk of an accident when using a high pressure car washer with circular jet nozzles

The water jet of a circular jet nozzle (dirt grinder) can cause externally invisible damage to the tyres or chassis parts. Components damaged in this way may unexpectedly fail.

- ▶ Never use a high pressure car washer with circular jet nozzles to clean the vehicle.
- ▶ Have damaged tyres or chassis parts replaced immediately.
- ▶ Never use a high pressure car washer to flush the air intake grille.

When using a high pressure car wash, to protect your vehicle, you should

- Maintain the high pressure nozzle at least 30 centimeters away from the vehicle.
- **Vehicle with decorative film:** vehicle parts may be covered with decorative film. Maintain at least 70 centimeters between the vehicle parts covered with decorative film and the nozzle of the high pressure car wash. Keep moving the nozzle of the high pressure car wash when cleaning. The water temperature of the high pressure car wash should be kept below 40°C.
- Observe the correct distance as stated in the User Manual of the equipment.
- Never direct the nozzle of the high pressure car wash at sensitive parts, such as tyres, crevices, electrical components, batteries, bulbs, and ventilation slots.

Washing the vehicle manually

Observe regulatory requirements, such as in many countries, manual washing is only allowed at specially designated service racks.

1. Use a mild cleaning agent such as car shampoo.

2. Apply a mild cleaner with a soft car sponge. Never expose the vehicle to direct sunlight when doing so.
3. Carefully rinse the vehicle with water and dry the vehicle off with a chamois

Notes on paintwork/matte finish paintwork care

Observe the following notes:

Parts	Cleaning and care	Avoiding paintwork damage
Paintwork	<ul style="list-style-type: none"> ● Insect remains: soak with insect remover and rinse off the treated areas. ● Bird droppings: soak with water and rinse off. ● Tree resin, oils, fuels and greases: remove by gently rubbing with a cloth soaked in cleaning petroleum or lighter fluid. ● Coolant and brake fluid: remove with a damp cloth and clean water. ● Tar stains: use tar remover. ● Wax: use silicone remover. 	<ul style="list-style-type: none"> ● Never attach stickers, films or similar materials. ● Remove dirt immediately by rubbing carefully.
Matte finish		<ul style="list-style-type: none"> ● Do not polish the vehicle and wheels. ● Only use car washes that correspond to the latest engineering standards ● Never use paint cleaners, buffing or polishing products, or gloss preservers such as wax. ● Have paint repair work carried out at a smart Authorized Service Partner.

Notes on cleaning the decorative film

Observe the matte finish care instructions in Notes on Paintwork/matte Finish

Paintwork Care (→ Page 182). These also apply to decorative film.

Observe the following notes:

Cleaning	Never damage the decorative film
<ul style="list-style-type: none"> ● For cleaning, use plenty of water and a neutral cleaner without additives or abrasives. ● Remove dirt as soon as possible and avoid rubbing it too hard. Otherwise it may cause irreparable damage to the decorative film. ● If there is dirt on the paint or the decorative film is tarnished: Use a paint cleaner suitable for the vehicle. ● Insect remains: soak with insect remover and rinse off the treated areas. ● Bird droppings: soak with water and rinse off. ● To prevent water stains, dry the vehicle with decorative film after each cleaning by using a soft absorbent cloth. 	<ul style="list-style-type: none"> ● The service life and color of decorative film are affected by: <ul style="list-style-type: none"> - Sunshine - Temperature, such as hot air blower - Weather condition - Stoning and smudging - Chemical cleaner - Freak oil ● Never use car wax for matte, glossy or structured decorative films. It may cause permanent stains.

Scratches, rust deposits, corroded areas, and damage caused by improper care may not be fully repaired. In this case, go to a smart Authorized Service Partner.

You can learn more about care and cleaning products from the manufacturer.

After removing the decorative film, a visual difference may be noticed between the surface with decorative film and the surface without decorative film.

- ① Go to a smart Authorized Service Partner to treat or repair the decorative film.

Notes on external parts maintenance

⚠ WARNING Risk of being trapped due to enabling wipers while cleaning the windscreen

If the wipers begin to move while you are cleaning the windscreens or wiper blades, you may be trapped by the wiper arms.

- ▶ Be sure to switch off the wipers and the vehicle before cleaning the windscreen or wiper blades.

Observe the following notes:

Parts	Cleaning and care	Avoid damage to the vehicle.
Wheels/tyres	Use water and acid-free wheel cleaner.	<ul style="list-style-type: none"> ● Never use acid wheel cleaner to remove the dust caused by braking. It may damage wheel bolts and brake components. ● To prevent the brake disc and brake shoe from being corroded, clean the vehicle and drive a few minutes before parking. The brake disc and shoe heats up and dries.
Windows	Clean the inside and outside of the windows with a damp cloth.	Never clean the inside of the windows using a dry cloth, abrasive cleaner or solvent cleaner.
Wiper blades	Unfold the wiper blades and clean them with a damp cloth.	<p>Do not frequently clean the blades.</p> <p>Never use strong solvents.</p>
Exterior lighting	Clean lamp covers with a damp sponge and a mild cleaner such as vehicle cleaner.	Only use the cleaner or cleaning cloth suitable for plastic lamp covers.
Vehicle charging socket (high voltage battery)	Clean with a clean soft cloth or air gun.	Never use a high pressure car wash or cleaner, such as soap.
Sensor	Clean the sensors on the front and rear bumpers and radiator grille using a soft cloth and vehicle cleaner.	When using a high pressure washer, keep a distance of more than 30 centimeters.
Camera	Clean the camera lens with water and a soft cloth.	Never use a high pressure car wash.

Notes on cleaning the interior

⚠ WARNING Risk of injury from plastic parts breaking off after the use of solvent-based care products

Care and cleaning products containing solvents can cause surfaces in the cockpit to become porous.

If the airbags are deployed, plastic parts may break away.

▶ Never use any care or cleaning products containing solvents to clean the cockpit.

⚠ WARNING Risk of injury or death from bleached seat belts

Bleaching or dyeing seat belts can severely reduce them.

This can, for example, cause seat belts to tear or fail in an accident.

▶ Never bleach or dye seat belts.

Observe the following notes:

Parts	Cleaning and care	Avoid damage to the vehicle.
Seat belts	Clean with lukewarm, mild detergent solution.	<ul style="list-style-type: none"> • Never use chemical cleaning agents. • Never dry the seat belt by heating above 80 °C or in direct sunlight
Displays	Carefully clean the surface with a cotton or microfibre cloth	<ul style="list-style-type: none"> • Switch off the display and let it cool down first. • It is recommended to enable the Screen cleaning mode before cleaning the display if the centre display is on. • Never use any other cleaning agent.
Plastic trim	Clean with a damp microfibre cloth.	<ul style="list-style-type: none"> • Never attach stickers, films or similar materials. • Never allow cosmetics, insect repellent or sun cream to come in contact with the plastic trim.
Ambient light strip	Neutral detergent is required for routine maintenance and cleaning.	Keep perfumes, cosmetics, sunscreen and pesticides away from ambient light strips. If grease described above or strong acids and alkalis come into contact with ambient light strips, wipe off them in time to avoid cracking the ambient light strips.

Parts	Cleaning and care	Avoid damage to the vehicle.
Roof lining	Clean with a brush or dry cleaner.	
Carpets	Use carpet or fabric cleaner	
Genuine leather seat covers	Clean them with a wet cloth and then wipe with a dry cloth.	<ul style="list-style-type: none"> ● Never soak the leather. ● Never use a microfibre cloth.
Seat covers	Clean with a damp cloth.	Never use a microfibre cloth.
Imitation leather seat covers	Clean the entire seat cover with a damp cotton cloth and a 1% soapy water solution.	<ul style="list-style-type: none"> ● Never use a microfibre cloth. ● Never use corrosive substances, such as 84 disinfectant liquid, bleaching powder, laundry detergent, kitchenware cleaner, toilet cleaner, etc. ● Never use liquids that may contain organic solvents, such as perfume, car diffuser or air fresheners, particularly if the products' packaging is clearly marked with "This product is flammable. Keep away from fire and heat sources when using".
Cloth seat covers	Clean the entire seat cover with a damp microfibre cloth and a 1% soapy water solution.	

Batteries**Notes on the 12 V battery**

⚠ WARNING Risk of accident caused by operating the 12 V battery improperly

Operating the 12 V battery improperly may cause risks such as short circuit. This can lead to function restrictions in the safety-relevant systems, such as lighting system, anti-lock brake system or electronic stability control system. The operating safety of your vehicle may be restricted.

- ▶ In the event of a short circuit or a similar incident, contact a smart Authorized Service Partner immediately.
- ▶ Do not continue driving.
- ▶ It is recommended to have the work related to the 12 V battery carried out at a smart Authorized Service Partner.

For safety reasons, it is recommended that you only use the 12 V battery that has been tested and approved by smart for your vehicle. These 12 V batteries provide enhanced impact protection, which can prevent acid burns to the vehicle occupants due to 12 V battery damage in the event of an accident.

⚠ WARNING Risk of explosion from electrostatic accumulation

The electrostatic accumulation can cause sparks which may ignite the highly flammable gas mixture in the 12 V battery.

- ▶ Before operating the 12 V battery, touch the vehicle metal body part to release any possible electrostatic accumulation.

⚠ WARNING Chemical burn caused by the 12 V battery acid

The 12 V battery acid is corrosive.

- ▶ Prevent the 12 V battery acid from contacting the skin, eyes or clothing.
- ▶ Do not lean over the 12 V battery.
- ▶ Do not inhale the 12 V battery vapour.
- ▶ Place the 12 V battery out of the reach of children.
- ▶ In case of accidental contact with the 12 V battery acid, flush off the acid thoroughly with plenty of water, and seek medical attention immediately.

♻ ENVIRONMENTAL NOTE Environmental damage from improper disposal of batteries



Batteries contain pollutants. Do not discard batteries with the household rubbish.



- ▶ Dispose of batteries in an environmentally responsible manner. Take discharged batteries to a smart Authorized Service Partner or a used battery recycling point.

To disconnect the 12 V battery, contact a smart Authorized Service Partner.

When disposing of 12 V batteries, observe the safety notes and take protective measures.



Explosive risk.



When disposing of 12 V batteries, do not ignite, use naked flame or smoke. Avoid any spark.



The electrolyte or 12 V battery acid is corrosive. Protect your skin, eyes or clothing from contacting with electrolyte or acid. Wear appropriate protective clothing, especially protective gloves, apron and mask. If any part of your body is splashed with electrolyte or acid, rinse it with plenty of water immediately and thoroughly. If necessary, seek medical attention as soon as possible.



Wear protective glasses.



Keep it away from children.



Observe the instructions in the User Manual.

If you plan to leave your vehicle unused for an extensive period of time, consult a smart Authorized Service Partner.

Start assist and charging the 12 V battery

Contact the smart Authorized Service Partner for start assist or charging the battery.

Replacing the 12 V battery

Contact a qualified service centre, such as a smart Authorized Service Partner, for battery replacement.

Notes on the high voltage battery

⚠ WARNING Risk of vehicle damage and personnel injury from high voltage system

- ▶ Do not touch, move or disassemble the high voltage battery, orange high voltage cables or any component with a high voltage warning symbol.
- ▶ Do not park the vehicle for an extensive period of time in a humid environment, such as a waterlogged parking lot.

⚠ WARNING Risk of explosion from excessive internal pressure of the high voltage battery

In the event of a vehicle fire, the internal pressure of the high voltage battery could exceed the critical value. In this case, flammable gas may escape through a bleed valve in the vehicle's underbody.

The gas can be ignited.

- ▶ Stop the charging process immediately in case of unusual odours, smoke or burn marks.
- ▶ Leave the danger zone immediately. Secure the danger zone at a sufficient distance.
- ▶ Call the fire department.

The high voltage battery equipped on this vehicle conforms to the ECE R100.03 requirements regarding high voltage battery safety.

To achieve the longest service life of the high voltage battery, the state of charge should always be kept sufficient. If you need to park the vehicle for a long time, check the state of charge. The high voltage battery depletes and becomes damaged if the vehicle is left unused for a long time.

If the vehicle is left unused for a long time, run it for a few minutes every 4 weeks. If

the state of charge is low, charge the battery.



Explosive risk.



When disposing of power batteries, do not ignite, use open flame or smoke. Avoid any spark.



Electrolyte or power cell acid is corrosive. Protect your skin, eyes or clothing from contacting with electrolyte or acid. Wear appropriate protective clothing, especially protective gloves, apron and mask. If any part of your body is splashed with electrolyte or acid, rinse it with plenty of water immediately and thoroughly. If necessary, seek medical attention as soon as possible.



Wear protective glasses.



Keep it away from children.



Observe the instructions in the User Manual.

Fuses

Replacing fuses

⚠ WARNING Accident risk may occur when the user changes the fuse

Unauthorized fuse replacement may cause:

- ▶ Vehicle damage.
- ▶ Fire.

For the replacement of all fuses, it is recommended to have the required repairs carried out at a smart Authorized Service Partner.

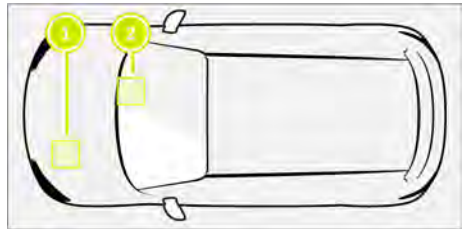

Location of fuses

Fuse box **1** in the front compartment.

Fuse box below the instrument panel **2**.

Technical data description

Technical data description

All technical data is subject to the official vehicle documentation. All data listed in this manual apply to the vehicle base model without accessories, consult a smart Authorized Service Partner for details.

Drive form

The drive form depends on the trim lines, and this vehicle is available with either rear-wheel drive or four-wheel drive.

Electric drive

The type and model of electric drive installed in this vehicle are listed in the vehicle technical data label or vehicle registration document.

⚠ WARNING Risks caused by not observing the specified technical data

Be sure to use the vehicle strictly according to the specified technical data. If the specified values such as mass, payload, vehicle size and maximum vehicle speed specified in this manual are ignored or exceeded during use, accidents may occur and cause personal injury.

On-board electronics

Notes on unauthorized change of the motor and electronic equipment

⚠ NOTE Premature wear caused by inappropriate care

Inappropriate care may result in premature wear of vehicle components and cause the vehicle to lose driving permit.

- Always have the repair of electric and electronic equipment and relevant components carried out at a smart Authorized Service Partner.

Vehicle identification plate, vehicle identification number (VIN) and E-motor serial number

Vehicle identification plate



The vehicle identification plate ① is located on the lower section of the right B pillar.

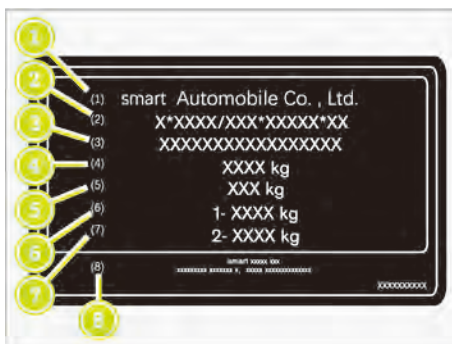

- ① Vehicle manufacturer
 - ② Approval number
 - ③ Vehicle identification number (VIN)
 - ④ Gross vehicle weight rating (GVWR)
 - ⑤ Gross combination weight rating (GCWR)
 - ⑥ Gross axle weight rating (GAWR) – front
 - ⑦ Gross axle weight rating (GAWR) – rear
 - ⑧ Manufacture representative information
- ① The data in the figure is for reference only. The figures are subject to the vehicle delivered.

Vehicle identification number (VIN)

Vehicle identification number (VIN) on the right front seat cross member

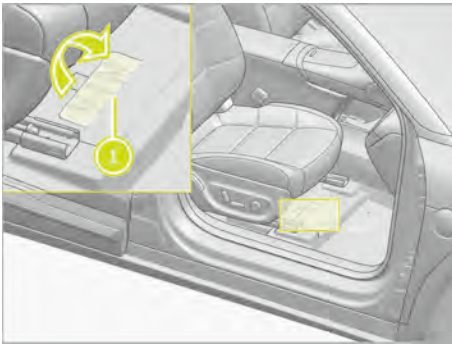

Fold away the floor cover to access the imprinted vehicle identification number (VIN)

1.

Vehicle identification number (VIN) on the lower edge of the windscreen

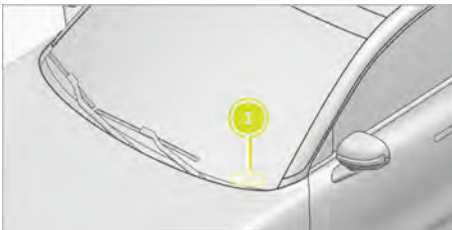

Vehicle identification number (VIN) **1.**

Read the vehicle identification number (VIN)

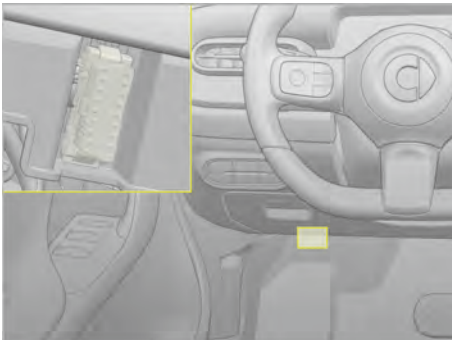

Vehicle identification number (VIN) can be retrieved by a diagnostic scan tool through the diagnostic system interface.

i If needed, contact a smart Authorized Service Partner.

E-motor serial number

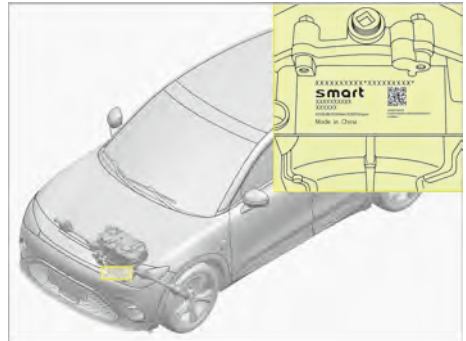

The model and serial number of the front E-motor can be found stamped on the underside of the front part of the motor.

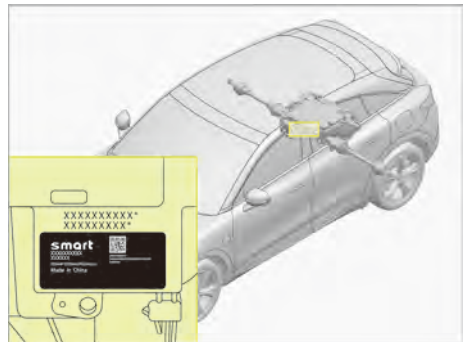

The label indicating the model and serial number of the rear E-motor is situated beneath the back part of the motor.

Consult a smart Authorized Service Partner for detailed information.

i The E-motor serial number in the figure is for reference. E-motor serial numbers are different among vehicles and may differ from the one shown here.

Operating fluids

Note on the operating fluids

⚠ WARNING Risk of injury caused by harmful operating fluid

Operating fluid may be poisonous and hazardous to health.

- ▶ Observe the note on the original vessel when using, storing or discarding operating fluid.
- ▶ Store operating fluid in the original vessel.
- ▶ Keep operating fluid out of the reach of children.

Operating fluid includes the following liquid:

- Lubricating oil
- Coolant
- Brake fluid
- Windscreen washer fluid

Please use smart authorized products. smart warranty does not include damage caused by using unauthorized products.

Notes on the brake fluid

Observe the notes on operating fluid (→ Page 192).

⚠ WARNING Risk of accident caused by air trap formed by the brake system

Brake fluid absorbs water in air continuously. It reduces boiling point of brake fluid. If the boiling point is too low, the brake system may form air trap during strong brake.

It reduces brake effect.

- ▶ Replace the brake fluid as per stipulated interval.

Replace the brake fluid at a qualified specialist workshop on a regular basis.

Please use smart authorized brake fluids.

Coolant

Observe the notes on operating fluid (→ Page 192).

⚠ WARNING Risk of fire and injury caused by coolant

Coolant may be ignited if contacting with high temperature parts in the front compartment.

- ▶ Cool the power system before adding coolant.
- ▶ Prevent the coolant from spilling around the filler cap.
- ▶ Clean coolant on parts thoroughly before starting the vehicle.

! NOTE Radiating heat when the outside temperature is high

If an inappropriate coolant is used, it cannot effectively prevent the power system from radiating heat when the outside temperature is high.

- ▶ Please use smart authorized coolant.
- ▶ Observe notes in the smart operating fluid specification

Have the coolant replaced regularly at a smart Authorized Service Partner.

Notes on the windscreen washer fluid

Observe the notes on operating fluid (→ Page 192).

⚠ WARNING Risk of fire and injury from windscreen washer concentrate

Windscreen washer concentrate is highly flammable.

- ▶ Do not ignite, use naked flame, smoke or cause spark when cleaning with windscreen washer concentrate.

! **NOTE** Damage of outside lighting by inappropriate windscreen washer fluid

Inappropriate windscreen washer fluid may damage plastic surface of outside lighting.

- ▶ Use windscreen washer fluid applicable to plastic surface.

! **NOTE** Nozzle blockage caused by mixed windscreen washer fluid

- ▶ Never mix different windscreen washer fluid.

i Frozen washer fluid can prevent the washer system from functioning due to cold climate. If the washer fluid lines are frozen, never use the washer to avoid damage.

Do not use the wiper when there is no washer fluid in the washer fluid tank, otherwise the service life of the wiper will be reduced.

When the temperature is lower than the freezing point, use the washer fluid containing antifreeze to avoid freezing of the washer pump, washer fluid tank and washer pipeline. Before replacing the washer fluid, please ensure to completely empty the original fluid in the washer fluid tank.

Refrigerant

Observe the notes on operating fluid (→ Page 192).

! **NOTE** Damage caused by inappropriate refrigerant

If an unauthorized refrigerant is used, the air conditioning control system may be damaged.

- ▶ Only use the refrigerant approved by smart.

! **NOTE** Air conditioning control system damage caused by inappropriate air conditioning compressor oil

- ▶ Only use air conditioning compressor oil authorized by smart.
- ▶ Never mix the air conditioning compressor oil authorized by smart with other oils.

The refrigerant instruction label is located in the front compartment.

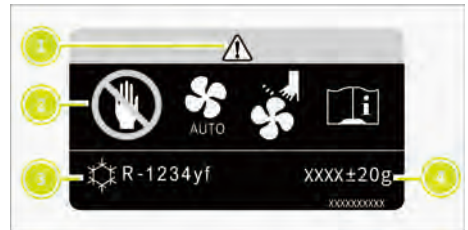

- 1** Hazard and maintenance warning symbol
- 2** Direct contact is prohibited
- 3** Refrigerant model
- 4** Refrigerant filling volume

The symbol 1 is a warning for the following situations:

- Possible hazard.
- Maintenance should be carried out at a smart Authorized Service Partner.

Refrigerant filling volume

Model	Refrigerant
Heat pump	950 g ± 20 g
Non-heat pump	500 g ± 20 g

Air conditioning compressor oil filling volume

Model	Air conditioning compressor oil
Heat pump	300 ml
Non-heat pump	150 ml

Vehicle parameters

Vehicle dimensions

Item	Rear wheel drive vehicles	All wheel drive vehicles
Length	4400 mm	
Width (without the rear-view mirrors)	1844 mm	
Height (without the roof rails)	1556 mm	
Front wheel track	1584 mm	
Rear wheel track	1601 mm	
Wheelbase	2785 mm	

Vehicle performance specifications

Mechanical performance

Items	Specification
Maximum speed	180 km/h(110 mph)
Minimum turning radius	5500 mm

Passability

Items	Without sport kit	With sport kit
Approach angle	17 °	17 °
Departure angle	22 °	22 °
Maximum incline*	35%	

Items	245 / 45 R19		245 / 40 R20	
	No load	Full load	No load	Full load
Minimum ground clearance	160 mm	135 mm	160 mm	135 mm

*: Maximum incline test conditions are as follows:

- On a dry road
- Within the gross vehicle weight rating

- At sea level
- Not towing a trailer

Suspension system specifications

Vehicle alignment specification

Item	Specification
Front wheel camber angle	$-46.5' \pm 3'$
Rear wheel camber angle	$-64.6' \pm 30'$
Kingpin inclination angle	$13.56^\circ \pm 0.5^\circ$
Kingpin caster angle	$5.0^\circ \pm 0.5^\circ$
Front wheel toe	$5.2' \pm 3'$
Rear wheel toe	$3.9' \pm 3'$

 All wheel alignment values are measured as single-side tyre parameters under the vehicle's factory-set loaded condition (standard equipment and all necessary fluids).

Weight and payload

Items	Rear wheel drive vehicles			All wheel drive vehicles
Kerb weight	1780 kg	1810 kg	1780 kg	1910 kg
Maximum laden mass - total	2230 kg	2260 kg	2199 kg	2360 kg
Maximum laden mass - front	931 kg	959 kg	972 kg	1053 kg

Items	Rear wheel drive vehicles			All wheel drive vehicles
	Maximum laden mass - rear	1299 kg	1301 kg	1227 kg
Maximum axle load - front	1100 kg			
Maximum axle load - rear	1340 kg			

Battery specifications

Besides state of charge and ambient temperature, charging capacity also determines the charge time. The charging

capacity depends on the supply voltage, the current intensity and the type of power supply.

High voltage battery specifications

Items	Specification 1	Specification 2
Rated voltage	392 V	380 V
Rated capacity	169 A·h	130.5 A·h
Number of cores	107	120
Weight (without coolant)	390 kg	409.5 kg

12 V battery specifications

Items	Specification
Rated voltage	12 V
Rated capacity	50 A·h

E-motor specifications

Item	E-motor specifications	
	Type 1	Type 2
Peak power	200 kW	115 kW
Maximum rotation speed	16500 RPM	16000 RPM

Item	E-motor specifications	
	Type 1	Type 2
Peak torque	343 N·m	200 N·m
Rated power	75 kW	41 kW
Rated rotation speed	5345 RPM	4950 RPM
Rated torque	134 N·m	80 N·m
Rated voltage	400 V	

Brake system specifications

Brake parameters

Item	Specification
Brake fluid	DOT4
Brake pedal full travel	119 mm
Brake pedal free travel	2 – 8 mm
 Replace the brake fluid regularly to guarantee the efficiency of the brake system. It is recommended to have the brake fluid replaced at a smart Authorized Service Partner.	

Reasonable service range of the brake friction sets

Item	Specification	
	Front wheel	Rear wheel
Standard thickness of the brake disc	Rear wheel drive: 28 mm	20 mm
	All wheel drive: 30 mm	
Minimum safety thickness of the brake disc	Rear wheel drive: 25 mm	18 mm
	All wheel drive: 27 mm	
Standard thickness of the brake pad*	Rear wheel drive: 16.5 mm	15.5 mm
	All wheel drive: 18 mm	

Item	Specification	
	Front wheel	Rear wheel
Minimum safety thickness of the brake pad*	Rear wheel drive: 8.5 mm	7.5 mm
	All wheel drive: 9 mm	
Minimum safety thickness of the brake pad**	3 mm	2 mm
*: thickness includes the back plate. **: brake lining thickness without the back plate.		

Wheel dynamic balance requirement

Item	Specification
Manual tyre changer: unilateral residue of dynamic balance	≤ 5g
Automatic tyre changer: unilateral residue of dynamic balance	≤ 8 g

Recommended tyre pressure

Item	Specification	
	No load	Full load
245 / 45 R19	250 kPa	290 kPa
245 / 40 R20	250 kPa	290 kPa

Seat specifications

Front seat parameters

Items	Electric adjustment of front seats
Designed seat position*	Slide forward by 210 mm and backward by 50 mm
Designed backrest angle*	25 °
Range of adjustment of the seat backrest	Adjust forward by 28° and backward by 44° from the designed angle

Items	Electric adjustment of front seats
Range of adjustment of seat cushion	Adjust upward by 32.5 mm and downward by 32.5 mm
*: when measuring the cushion depth.	

Second row seat parameters

Items	Middle seat	Outboard seats
Designed seat position	None	None
Designed seat backrest angle	The design angle is 20°, and the seat back can be put down forward	The design angle is 28 °, and the seat back can be put down forward
Range of adjustment of the seat backrest	20 °	28 °

Detailed publishing information

Internet

For more information about smart vehicle and smart Authorized Service Partner, visit the smart official website:

<http://www.smart.com>

Vehicle manufacturer

Zhejiang Haoqing Automobile Manufacturing (Xi'an Branch) Co., Ltd.

666 Geely Avenue, Jingwei New Town,
Economy and Technology Development
Zone, Xi'an, Shanxi Province

Finalization date

July, 2024

