

# Table of Contents

Contents

Table of Contents

Returning an end-of-life vehicle

Important safety note

Diagnostics connection

Qualified specialist workshop

Rescue card

Copyright

multifunction steering wheel

Centre console

Overhead control panel

Control panel

Useful information

Important safety notes

lamps

Introduction

Occupant safety

Fastening

Introduction

Kneebag

Head/thorax airbag

Children in the vehicle

Triggering

Brake

Child restraint system

ISOFIX

Top Tether

passenger airbag

On the front-passenger seat

children in the vehicle

Suitable positions

Child-proof locks

Pets in the vehicle

Rear doors

Protection against theft

Driving safety systems

Switching off

Important safety notes

Brake

Adaptive brake lights

Crosswind Assist

Key

Important safety notes

Replacing

Loss

Important safety notes

Useful information

Doors

Automatic

Emergency locking

Luggage compartment

Important safety notes

Tailgate

Side windows

Opening/closing

Hinged window

Folding top

Opening and closing

folding top

Operating the roller sunblinds for the panoramic roof

Correct driver's seat position

Useful information

Seats

Important safety notes

Folding down

Switching on/off

Steering wheel

Seat heating problem

Mirrors

Exterior lighting

Symmetrical dipped beam

Automatic headlamp mode

Adjusting the headlamp range

Headlamp flasher

Useful information

Interior lighting

Hazard warning lamps

Replacing bulbs

Replacing bulbs Important safety notes

replacing bulbs

Front foglamp

Brake lamps

Windscreen wipers

Interior lighting

Intermittent wipe

windscreen wipers

Useful information

Misting up

Overview of climate control systems

Recommendations

Operating the climate control system

Cooling with air dehumidification

Setting the air distribution

Demisting the windscreen

Demisting the windows

Adjusting the air vents

Air vents Important safety notes

Setting

Driving

Correct usage

Pulling away

Introduction

Colour display

Running-in notes

Useful information

Manual transmission

[Gear lever](#)

[Engaging reverse gear](#)

[Automatic transmission](#)

[Drive program display](#)

[Changing gear](#)

[Drive programs](#)

[automatic transmission](#)

[Gearshift paddles](#)

[lever lock](#)

[Refuelling](#)

[Parking](#)

[Parking](#)

[Parking brake](#)

[Fuel](#)

[Driving tips](#)

[Driving tips](#)

[New brake pads/linings](#)

[Aquaplaning](#)

[Winter driving](#)

[Driving systems](#)

[Cruise control Activating](#)

[Cancelling cruise control](#)

[Speed limiter](#)

[Parking aid](#)

[Reversing camera](#)

[driving systems](#)

[Lane Keeping Assist](#)

[Activating/deactivating](#)

[Important safety notes](#)

[Overview](#)

[Useful information](#)

[Displays and operation](#)

[Fuel gauge](#)

[Additional instruments](#)

[Monochrome](#)

[standard display](#)

[Menus and submenus](#)

[Message memory](#)

Settings menu

Setting

Setting the temperature unit

Monochrome display

Display messages (on-board computer with monochrome display)

Colour display

Display messages (on-board computer with colour display)

Safety systems

Display message

Display message

Display message

Display message

Display message

Driving systems

Tyres

Display message

Warning lamp

Warning and indicator lamps in the instrument cluster

Warning lamp

Indicator lamp

Warning lamp

Warning and indicator lamps

Warning lamp

Warning lamp

Warning lamp

Loading guidelines

Glove compartment

back

Readyspace seats

Lashing eyelets

Important safety notes

Centre console

Ashtray

Floormat

Useful information

Engine compartment cover

Checking service products

Important safety notes

Topping up

Service

Hiding

Automatic car wash

Care

High-pressure cleaner

Wheels

Exhaust pipe

Display

Carpets

Useful information

First-aid kit

Where will I find

Fire extinguisher

Flat tyres

TIREFIT kit

Battery (vehicle)

Important safety notes

Jump-starting

Important safety notes

Towing and tow-starting

Fitting the towing eye

Tow-starting Emergency engine starting

Fuse box in the front area

Electrical fuses

Allocation

Important safety notes

Operation

Checking

Useful information

Winter operation

In winter

Snow chains

Tyre pressure

tyre pressure

Important safety notes

Tyre pressure monitor

Warning message

Changing a wheel

Fitting a wheel

Changing a wheel

Raising the vehicle

Removing a wheel

Lowering the vehicle

Wheel and tyre combinations

General notes

Wheel and tyre combinations

Technical data

Useful information

Information on technical data

Two-way radio

Vehicle electronics

Vehicle identification plate

Identification plates

Engine number

Service products and capacities

Important safety notes

Additives

Engine oil

Notes

Vehicle data

Washer fluid

vehicle data

Other ManualsLib Projects



## >> Owner's Manual

smart forfour

## Symbols

In this Owner's Manual, you will find the following symbols:

### **WARNING**

Warning notes make you aware of dangers which could pose a threat to your health or life, or to the health and life of others.

### **Environmental note**

Environmental notes provide you with information on environmentally aware actions or disposal.

 Notes on material damage alert you to dangers that could lead to damage to your vehicle.

 These symbols indicate useful instructions or further information that could be helpful to you.

- ▶ This symbol designates an instruction you must follow.
- ▶ Several consecutive symbols indicate an instruction with several steps.
- (▷ This symbol tells you where you can find further information on a page) find further information on a topic.
- ▷▷ This symbol indicates a warning or an instruction that is continued on the next page.

**Display** This text indicates a message on the multifunction display.

## Let the fun begin!

Before you first drive off, read this Owner's Manual carefully and familiarise yourself with your vehicle. For your own safety and a longer vehicle life, follow the instructions and warning notices in this manual. Disregarding them may lead to damage to the vehicle or personal injury.

This Owner's Manual provides information on the most important functions of your vehicle.

The equipment or model designation of your vehicle may vary according to:

- model
- order
- country variant
- availability

The illustrations in this manual show a left-hand-drive vehicle. On right-hand-drive vehicles, the layout of components and controls differs accordingly.

smart is constantly updating its vehicles to the state of the art.

smart therefore reserves the right to introduce changes in the following areas:

- design
- equipment
- technical features

The equipment in your vehicle may therefore differ from that shown in the descriptions and illustrations.

The following are integral components of the vehicle:

- Owner's Manual
- Service Booklet
- Equipment-dependent supplements

Keep printed copies of the documents in the vehicle at all times. If you sell the vehicle, always pass the documents on to the new owner.

You can also use the smart guides app for tablets and smartphones.



Apple® iOS



Android™

Please note that the smart guides app may not currently be available in your country.

The technical documentation team at Daimler AG wishes you safe and pleasant motoring.





<b>Index</b> .....	4	<b>At a glance</b> .....	25
<b>Introduction</b> .....	18	<b>Safety</b> .....	37
		<b>Opening and closing</b> .....	67
		<b>Seats, steering wheel and mirrors</b> .....	83
		<b>Lights and windscreen wipers</b> .....	91
		<b>Climate control</b> .....	107
		<b>Driving and parking</b> .....	119
		<b>On-board computer and displays</b> .....	153
		<b>Stowing and features</b> .....	203
		<b>Maintenance and care</b> .....	213
		<b>Breakdown assistance</b> .....	227
		<b>Wheels and tyres</b> .....	247
		<b>Technical data</b> .....	265

1, 2, 3 ...

**12 V socket**

see Sockets

**A****ABS (Anti-lock Braking System)**

- Display message ..... 176
- Function/notes ..... 62
- Important safety notes ..... 62
- Warning lamp ..... 193

**Activating/deactivating air-recirculation mode** ..... 117

**Activating/deactivating cooling with air dehumidification** ..... 112

**Adaptive brake lights** ..... 64

**Additives (engine oil)** ..... 271

**Adjusting the headlamp range** ..... 94

**Air conditioning**

General notes ..... 108

**Air pressure**

see Tyre pressure

**Air vents**

- Important safety notes ..... 117
- Setting ..... 117
- Setting the centre air vents ..... 118
- Setting the side air vents ..... 118

**Air vents**

see Air vents

**Air-conditioning system**

see Climate control

**Airbag**

- Enabling and disabling the passenger airbag\* ..... 51
- Head/thorax airbag ..... 46
- Introduction ..... 43
- PASSENGER AIR BAG indicator lamps ..... 39
- Warning lamp ..... 191

**Airbags**

- Front airbag (driver, front passenger) ..... 45
- Important safety guidelines ..... 44
- Kneebag ..... 45
- Triggering ..... 46

**Alarm**

Anti-theft alarm system ..... 60

- Priming/deactivating function .... 60
- Switching off ..... 61

**Ambient lighting**

- Setting the brightness ..... 166
- Switching on/off ..... 166

**Animals**

see Pets in the vehicle

**Anti-lock Braking System**

see ABS (Anti-lock Braking System)

**Anti-skid chains**

see Snow chains

**Anti-theft alarm system**

- Function ..... 60
- Priming/deactivating ..... 60
- Switching off the alarm ..... 61

**Aquaplaning** ..... 144

**Ashtray** ..... 211

**Authorised workshop**

see Qualified specialist workshop

**Automatic engine Start/Stop function**

Display message ..... 186

**Automatic engine switch-off (automatic start/stop system)** ..... 124

**Automatic headlamp mode** ..... 93

**Automatic Start/Stop function**

- Indicator lamp (green) ..... 201
- Warning and indicator lamps (yellow) ..... 201

**Automatic start/stop system**

- Activating/deactivating ..... 125
- Automatic engine switch-off ..... 124
- General information ..... 123
- Introduction ..... 123

**Automatic transmission**

- Accelerator pedal position ..... 130
- Changing gear ..... 130
- Display message (colour display) ..... 187
- Display message (monochrome display) ..... 169
- Drive program display ..... 129
- Drive programs ..... 131
- Driving tips ..... 130
- Emergency running mode ..... 135
- Gearshift paddles ..... 133
- Kickdown ..... 131

Malfunction (on-board computer with colour display) .....	187
Malfunction (on-board computer with monochrome display) .....	169
Manual shifting .....	131
Manually releasing the selector lever lock .....	135
Overview .....	128
Problem (fault) .....	135
Program selector button .....	131
Pulling away .....	122
Selector lever .....	129
Starting the engine .....	122
Transmission position display ...	129
Transmission positions .....	130
<b>Automatic transmission emergency running mode</b> .....	135

## B

### Battery (key)

Important safety notes .....	69
Replacing .....	69

### Battery (vehicle)

Charging .....	235
Display message .....	179
Important safety notes .....	233
Jump starting .....	236
Warning and indicator lamps .....	196

### Belt

see Seat belts

### Belt tensioner

Activation .....	46
------------------	----

### Blower

see Climate control

### Bonnet (front)

see Service cover

### Boot

see Tailgate

### Brake

EBD .....	65
-----------	----

### Brake fluid

Display message .....	175
Notes .....	272

### Brake force distribution

see EBD (electronic brake force distribution)

### Brake lamps

Adaptive .....	64
Changing bulbs .....	100
Display message (colour display) .....	186

### Brake lights

Display message (monochrome display) .....	168
--	-----

### Brakes

ABS .....	62
Brake fluid (notes) .....	272
Driving tips .....	142
Important safety notes .....	142
Parking brake .....	139
Warning lamp .....	191

### Breakdown

see Flat tyre  
see Towing away/tow-starting

### Bulbs

see Replacing bulbs

## C

### Calling up a fault

see Display messages

### Capacities (technical data) .....

268

### Car

see Vehicle

### Car key

see Key

### Car wash

see Care

### Car wash (care) .....

220

### Care

Automatic car wash .....	220
Carpets .....	225
Display .....	224
Exhaust pipe .....	223
Exterior lighting .....	223
Gear or selector lever .....	224
General notes .....	220
High-pressure cleaner .....	221
Interior .....	224
Paint .....	221
Plastic trim .....	224
Reversing camera .....	223
Roof lining .....	225
Seat belt .....	225

- Seat cover ..... 224
- Sensors ..... 223
- Steering wheel ..... 224
- Washing by hand ..... 221
- Wheels ..... 222
- Windows ..... 222
- Wiper blades ..... 222
- Cargo box**
- Removing (rear seats) ..... 208
- Central locking**
- Locking/unlocking (key) ..... 69
- Centre console** ..... 33
- Changing bulbs**
- Brake lamps ..... 100
- Dipped-beam headlamps ..... 99
- Front foglamp ..... 99
- Main-beam headlamps ..... 99
- Rear foglamp ..... 100
- Reversing lamps ..... 100
- Tail lamps ..... 100
- Turn signals (front) ..... 98
- Turn signals (rear) ..... 100
- Child seat**
- Forward-facing restraint system ..... 53
- ISOFIX ..... 49
- On the front-passenger seat ..... 52
- Rearward-facing restraint system ..... 53
- Recommendations ..... 58
- Suitable positions ..... 54
- Top Tether ..... 50
- Child-proof locks**
- Important safety notes ..... 59
- Rear doors ..... 60
- Children**
- Restraint systems ..... 48
- Cigarette lighter** ..... 211
- Cleaning**
- see Care
- Climate control**
- Air conditioning ..... 109
- Automatic air conditioning ..... 111
- Controlling automatically ..... 113
- Cooling with air dehumidification ..... 112
- Demisting the windows ..... 115
- Demisting the windscreen ..... 114
- Heating ..... 109
- Notes on using the air-conditioning system ..... 109
- Notes on using the automatic climate control ..... 111
- Overview of systems ..... 108
- Problem with the rear window heating ..... 117
- Setting the air distribution ..... 113
- Setting the air vents ..... 117
- Setting the airflow ..... 114
- Setting the temperature ..... 113
- Switching air-recirculation mode on/off ..... 117
- Switching on/off ..... 111
- Switching the rear window heating on/off ..... 115
- Clock**
- Setting (dashboard clock) ..... 156
- Cockpit**
- Overview ..... 26
- Constant headlamp mode**
- see Daytime driving lights
- Consumption statistics (colour display)** ..... 160
- Controlling speed**
- see Cruise control
- Coolant**
- Battery ..... 217
- Checking the level ..... 218
- Drive system ..... 217
- General notes ..... 272
- Important safety notes ..... 217
- Setting the temperature unit ..... 166
- Temperature gauge ..... 162
- Topping up ..... 218
- Warning lamp ..... 197
- Coolant (engine)**
- Display message ..... 181
- Cooling**
- see Climate control
- Copyright** ..... 23
- Cover (front)**
- see Service cover
- Crosswind Assist** ..... 65
- Cruise control**
- Activating ..... 145
- Buttons ..... 145

- Calling up the speed last stored .. 146
  - Cancelling cruise control ..... 146
  - Deactivating ..... 146
  - Display message (colour display) ..... 183
  - Display message (monochrome display) ..... 172
  - Driving systems ..... 145
  - Function/notes ..... 145
  - General notes ..... 145
  - Important safety notes ..... 145
  - Increasing/decreasing the speed ..... 146
  - Storing and maintaining current speed ..... 145
  - Cup holder**
    - Centre console ..... 210
    - Important safety notes ..... 209
    - Rear centre console ..... 210
    - Rear compartment ..... 210
  - Cup holder**  
see Cup holder
- D**
- Dashboard**
    - Additional instruments ..... 156
  - Dashboard**  
see Cockpit
  - Dashboard clock** ..... 156
  - Data**  
see Technical data
  - Daytime driving lights**
    - Function/notes ..... 93
  - Dealership**  
see Qualified specialist workshop
  - Declarations of conformity** ..... 20
  - Diagnostics connection** ..... 20
  - Digital speedometer**
    - Display ..... 154
    - Setting the display ..... 165
  - Dipped-beam headlamps**
    - Changing bulbs ..... 99
    - Setting for driving abroad (symmetrical) ..... 92
    - Switching on/off ..... 94
  - Display**
    - Colour ..... 159
    - Menu (on-board computer with colour display) ..... 164
    - Monochrome ..... 157
  - Display (cleaning instructions)** ..... 224
  - Display message**
    - Calling up (message memory) ..... 162
    - Colour display ..... 173
    - Driving systems ..... 182
    - General notes (on-board computer with colour display) ..... 173
    - General notes (on-board computer with monochrome display) .. 168
    - Monochrome display ..... 168
    - Setting the language ..... 166
  - Display messages**
    - Engine ..... 179
    - Hiding ..... 173
    - Lights ..... 186
    - Safety systems ..... 174
    - Service display ..... 218
    - Tyres ..... 184
    - Vehicle ..... 186
  - Distance recorder**
    - Monochrome display ..... 158
  - Distance recorder**  
see Trip meter
  - Distance warning function**
    - Function/notes ..... 62
    - Warning lamp (red) ..... 195
    - Warning lamp (yellow) ..... 194
  - Door**
    - Automatic locking (switch) ..... 73
    - Central locking/unlocking (key) ... 69
    - Control panel ..... 35
    - Display message ..... 186
    - Emergency locking ..... 74
    - Emergency unlocking ..... 74
    - Important safety notes ..... 72
    - Opening (from the inside) ..... 72
    - Warning lamp ..... 200
  - Drive program**
    - Display ..... 129
  - Drive programs**
    - Automatic transmission ..... 131
  - Driver's door**  
see Door
  - Driver's seat**  
see Seats

- Driving abroad**  
 smart service ..... 220  
 Symmetrical dipped beam ..... 92
- Driving on flooded roads** ..... 144
- Driving safety system**  
 EBD (electronic brake force distribution) ..... 65
- Driving safety systems**  
 ABS (Anti-lock Braking System) .... 62  
 Adaptive brake lights ..... 64  
 Distance warning function ..... 62  
 ESP® (Electronic Stability Program) ..... 64  
 ETS (Electronic Traction System) ..... 64  
 Important safety guidelines ..... 61  
 Overview ..... 61
- Driving system**  
 Parking aid ..... 148  
 Speed limiter ..... 147
- Driving systems**  
 Cruise control ..... 145  
 Display message ..... 182  
 Lane Keeping Assist ..... 151  
 Reversing camera ..... 149
- Driving tips**  
 Aquaplaning ..... 144  
 Automatic transmission ..... 130  
 Brakes ..... 142  
 Downhill gradient ..... 142  
 Driving abroad ..... 92  
 Driving in winter ..... 144  
 Driving on flooded roads ..... 144  
 Driving on wet roads ..... 144  
 Fuel ..... 140  
 General ..... 140  
 Icy road surfaces ..... 144  
 Limited braking efficiency on salted roads ..... 143  
 New brake pads/linings ..... 143  
 Running-in tips ..... 120  
 Snow chains ..... 251  
 Subjecting brakes to a load ..... 143  
 Symmetrical dipped beam ..... 92  
 Wet road surface ..... 143
- E**
- EBD (electronic brake force distribution)**  
 Display message ..... 175  
 Function/notes ..... 65  
 Indicator lamp ..... 192
- eco score**  
 Display (on-board computer with colour display) ..... 161  
 Display (on-board computer with monochrome display) ..... 157  
 Function/notes ..... 140
- Electrical fuses**  
 see Fuses
- Electromagnetic compatibility**  
 Declaration of conformity ..... 20
- Electronic Brake-force Distribution**  
 see EBD (electronic brake force distribution)
- Electronic Traction System**  
 see ETS (Electronic Traction System)
- Emergency release**  
 Driver's door ..... 74
- Emergency unlocking**  
 Tailgate ..... 76  
 Vehicle ..... 74
- Engine**  
 Automatic start/stop system ..... 123  
 Display message ..... 179  
 Engine number ..... 268  
 Jump-starting ..... 236  
 Running irregularly ..... 126  
 Starting problems ..... 126  
 Starting the engine with the key .. 122  
 Stopping ..... 139  
 Tow-starting (vehicle) ..... 240  
 Warning lamp (engine diagnostics) ..... 196
- Engine compartment cover** ..... 214
- Engine electronics**  
 Notes ..... 266  
 Problem (fault) ..... 126
- Engine oil**  
 Additives ..... 271  
 Checking the oil level ..... 214  
 Display message ..... 180

- Filling capacity ..... 271
  - Notes about oil grades ..... 271
  - Notes on oil level/consumption ... 214
  - Topping up ..... 215
  - Viscosity ..... 272
  - Warning lamp ..... 197
  - Engine oil additives**
    - see Additives (engine oil)
  - Environmental protection**
    - Returning an end-of-life vehicle ..... 18
  - ESP® (Electronic Stability Program)**
    - Characteristics ..... 64
    - Crosswind Assist ..... 65
    - Display message ..... 177
    - ETS ..... 64
    - Function/notes ..... 64
    - General notes ..... 64
    - Important safety guidelines ..... 64
    - Warning and indicator lamps ..... 193
  - ETS (Electronic Traction System) ..... 64**
  - Exhaust pipe (cleaning instructions) ..... 223**
  - Exterior lighting**
    - Cleaning ..... 223
    - Settings options ..... 93
  - Exterior mirrors**
    - Adjusting (electrically) ..... 90
    - Adjusting (manually) ..... 90
    - Out of position (troubleshooting) ..... 90
- F**
- Fault message**
    - see Display messages
  - Filler cap**
    - see Fuel filler flap
  - Fire extinguisher ..... 229**
  - First-aid kit ..... 228**
  - Fitting a wheel**
    - Fitting a wheel ..... 259
    - Lowering the vehicle ..... 259
    - Preparing the vehicle ..... 256
    - Raising the vehicle ..... 257
    - Removing a wheel ..... 258
    - Securing the vehicle against rolling away ..... 256
  - Flat tyre**
    - Preparing the vehicle ..... 229
    - TIREFIT kit ..... 230
  - Floormat ..... 212**
  - Foglamps**
    - Switching on/off ..... 94
  - Folding top**
    - Important safety notes ..... 79
    - Operating ..... 80
    - Problem (malfunction) ..... 81
  - Frequencies**
    - Mobile phone ..... 266
    - Two-way radio ..... 266
  - Front cover**
    - see Service cover
  - Front foglamps**
    - Changing bulbs ..... 99
  - Frontal area cover**
    - see Service cover
  - Fuel**
    - Additives ..... 270
    - Consumption information ..... 270
    - Consumption statistics ..... 160
    - Displaying the current consumption (colour display) ..... 162
    - Displaying the current consumption (monochrome display) ... 157
    - Driving tips ..... 140
    - E10 ..... 269
    - Fuel gauge ..... 155
    - Grade (petrol) ..... 269
    - Important safety notes ..... 269
    - Problem (malfunction) ..... 138
    - Refuelling ..... 136
    - Tank content/reserve fuel ..... 269
  - Fuel consumption**
    - Displaying (on-board computer with monochrome display) ..... 158
    - Resetting data (on-board computer with monochrome display) .. 158
  - Fuel filler flap**
    - Opening ..... 137
  - Fuel level**
    - Gauge ..... 155
  - Fuel reserve**
    - see Fuel
  - Fuel tank**
    - Capacity ..... 269

Problem (malfunction) .....	138
<b>Fuses</b>	
Allocation .....	243
Before changing .....	241
Dashboard fuse box .....	242
Fuse box in the front area .....	241
Important safety notes .....	241

## G

<b>Gear or selector lever (cleaning instructions)</b> .....	224
<b>Genuine Mercedes-Benz parts</b> .....	18
<b>Glove compartment</b> .....	205

## H

<b>Handbrake</b>	
see Parking brake	
<b>Hands-free system</b>	
see Mobile phone	
<b>Hazard warning lamps</b> .....	96
<b>Head restraints</b>	
Adjusting (rear) .....	87
<b>Head/thorax airbag</b> .....	46
<b>Headlamp flasher</b> .....	95
<b>Headlamps</b>	
Misting up .....	96
see Automatic headlamp mode	
<b>Heating</b>	
see Climate control	
<b>High-pressure cleaners</b> .....	221
<b>Hill start assist</b> .....	123
<b>Hinged windows</b>	
Opening/closing .....	78
see Side windows	

## I

<b>Ice warning</b>	
Display message (colour display) .....	179
Display message (monochrome display) .....	173
Warning lamp (colour display) ....	155
Warning lamp (monochrome display) .....	155
<b>Ignition key</b>	
see Key	

<b>Ignition lock</b>	
see Key positions	
<b>Immobiliser</b> .....	60
<b>Indicator and warning lamp</b>	
Restraint system .....	191
<b>Indicator and warning lamps</b>	
Coolant .....	197
Engine diagnostics .....	196
<b>Indicator lamps</b>	
see Warning and indicator lamps	
<b>Instrument cluster</b>	
Overview (colour display) .....	29
Overview (monochrome display) ....	27
Warning and indicator lamps (colour display) .....	30
Warning and indicator lamps (monochrome display) .....	28
<b>Instrument cluster lighting</b>	
Notes .....	154
Setting .....	164
<b>Instrument lighting</b>	
see Instrument cluster lighting	
<b>Interior lighting</b> .....	96
Automatic control system .....	96
Changing bulbs .....	101
Overview .....	96
Reading lamp .....	96
Setting the ambient lighting .....	166
<b>Intermittent wipe</b> .....	102
<b>ISOFIX child seat securing system</b> .....	49

## J

<b>Jack</b>	
Using .....	257
<b>Jump start (engine)</b>	
see Jump starting (engine)	
<b>Jump starting (engine)</b> .....	236

## K

<b>Key</b>	
Changing the battery .....	69
Door central locking/unlocking ....	69
Important safety notes .....	68
Loss .....	71
Positions (ignition lock) .....	121
Problem (malfunction) .....	71

- Starting the engine ..... 122
  - Key positions (ignition lock)** ..... 121
  - Kickdown**
    - Driving tips ..... 131
    - Manual gearshifting ..... 134
  - Kneebag** ..... 45
- L**
- Lamps**
    - see Warning and indicator lamps
  - Lane Keeping Assist**
    - Activating/deactivating ..... 152
    - Function/information ..... 151
    - Warning lamp (colour display) .... 182
    - Warning lamp (monochrome display) ..... 171
  - Lane recognition system (automatic)**
    - see Lane Keeping Assist
  - Language (on-board computer)** ..... 166
  - Lashing eyelets** ..... 208
  - Licence plate lighting**
    - Changing ..... 100
  - Light sensor (display message)** ..... 189
  - Lighting**
    - see Lights
  - Lights**
    - Automatic headlamp mode ..... 93
    - Dipped-beam headlamps ..... 94
    - Display message ..... 186
    - Driving abroad ..... 92
    - Foglamps ..... 94
    - Hazard warning lamps ..... 96
    - Headlamp flasher ..... 95
    - Headlamp range ..... 94
    - Light switch ..... 93
    - Main-beam headlamps ..... 95
    - Rear foglamp ..... 94
    - Setting the ambient lighting ..... 166
    - Side lamps ..... 94
    - Turn signals ..... 95
    - see Interior lighting
    - see Replacing bulbs
  - Limiter**
    - Buttons ..... 147
    - Calling up the last speed stored .. 148
    - Cancelling ..... 148
    - Deactivating ..... 148
    - Display message (colour display) ..... 182
    - Display message (monochrome display) ..... 171
    - Exceeding the stored speed ..... 148
    - General notes ..... 147
    - Increasing/decreasing the speed ..... 148
    - Storing the speed ..... 147
  - Limiting the speed**
    - see Speed limiter
  - Loading guidelines** ..... 204
  - Locking**
    - see Central locking
  - Locking (doors)**
    - Automatic ..... 73
    - Emergency locking ..... 74
    - From inside (central locking button) ..... 73
  - Locking centrally**
    - see Central locking
  - Loudspeaker**
    - see Subwoofer
  - Lubricant additives**
    - see Additives (engine oil)
  - Luggage compartment enlargement ...** 206
- M**
- M+S tyres (winter tyres)** ..... 250
  - Main-beam headlamps**
    - Changing bulbs ..... 99
    - Switching on/off ..... 95
  - Manual transmission**
    - Display message (colour display) ..... 187
    - Display message (monochrome display) ..... 168
    - Engaging reverse gear ..... 128
    - Gear lever ..... 127
    - Malfunction (on-board computer with colour display) ..... 189
    - Malfunction (on-board computer with monochrome display) ..... 170
    - Pulling away ..... 122
    - Shift recommendation ..... 128
    - Shifting to neutral ..... 127

- Starting the engine ..... 122
- Manually releasing the selector lever lock (automatic transmission) .** 135
- Message memory (colour display) .....** 162
- Messages**
  - see Display messages
- Mirrors**
  - see Exterior mirrors
  - see Rear-view mirror
- Mobile phone**
  - Frequencies ..... 266
  - Installation ..... 266
  - Transmission output (maximum) .. 266
- Model series**
  - see Vehicle identification plate
- Multi-functional seat**
  - see Seats
- Multifunction steering wheel**
  - Overview ..... 31

## N

- Notes on running in a new vehicle ....** 120

## O

- Occupant safety**
  - Children in the vehicle ..... 47
  - Important safety notes ..... 38
  - Pets in the vehicle ..... 60
- Oil**
  - see Engine oil
- On-board computer**
  - Display submenu ..... 164
  - Displaying a service message .... 219
  - Important safety notes ..... 154
  - Menu overview (colour display) .. 160
  - Menu overview (monochrome display) ..... 158
  - Message memory ..... 162
  - Operating (colour display) ..... 159
  - Operating (monochrome display) .. 156
  - Selecting the language ..... 166
  - Service menu ..... 162
  - Settings menu ..... 163
- On-board computer\***
  - Messages menu ..... 162
- On-board diagnostics interface**
  - see Diagnostics connection

- Operating instructions**
  - Vehicle equipment ..... 19
- Operating safety**
  - Declaration of conformity ..... 20
  - Important safety note ..... 19
- Operating system**
  - see On-board computer
- Outside temperature display**
  - Ice warning (colour display) ..... 155
  - Ice warning (monochrome display) ..... 155
  - Notes ..... 155
  - Setting the units ..... 166
- Overhead control panel .....** 34
- Overrevving range .....** 156

## P

- Paint code .....** 267
- Paintwork (cleaning instructions) ....** 221
- Panoramic roof**
  - Operating roller sunblinds ..... 81
- Park brake**
  - see Parking brake
- Parking .....** 138
  - Important safety notes ..... 138
  - Parking brake ..... 139
  - Reversing camera ..... 149
  - Switching off the engine ..... 139
- Parking brake**
  - Display message ..... 174
  - Notes/function ..... 139
  - Warning lamp ..... 191
- PASSENGER AIR BAG**
  - Disabling/activating ..... 51
  - Indicator lamps ..... 39
- Passenger airbag**
  - Enabling and disabling\* ..... 51
  - Problem (malfunction)\* ..... 54
- Passenger seat**
  - Folding down ..... 86
- Petrol .....** 269
- Pets in the vehicle .....** 60
- Plastic trim (cleaning instructions) .....** 224
- Power windows**
  - see Side windows
- Program selector button .....** 131

- Protection against theft**
    - Anti-theft alarm system ..... 60
    - Immobiliser ..... 60
  - Protection of the environment**
    - General notes ..... 18
  - Pulling away**
    - Automatic transmission ..... 122
    - General notes ..... 122
    - Manual transmission ..... 122
- Q**
- QR code**
    - Rescue card ..... 22
  - Qualified specialist workshop** ..... 21
- R**
- Radio-based vehicle components**
    - Declaration of conformity ..... 20
  - Rain/light sensor (display message)** . 189
  - Reading lamp** ..... 96
  - Readyspace seats** ..... 207
  - Rear bench seat**
    - Folding the backrest forwards/  
back ..... 206
  - Rear foglamp**
    - Changing bulbs ..... 100
    - Switching on/off ..... 94
  - Rear lamps**
    - Changing bulbs ..... 100
  - Rear parking aid**
    - Activating/deactivating ..... 149
    - Function/notes ..... 148
  - Rear seat**
    - Adjusting the angle of the  
backrests ..... 207
  - Rear seat**
    - see Rear bench seat
  - Rear seats**
    - readyspace seats ..... 207
    - Removing cargo box ..... 208
    - Rotating the seat cushions ..... 207
  - Rear shelf** ..... 208
  - Rear window heating**
    - Problem (fault) ..... 117
    - Switching on/off ..... 115
  - Rear window wiper**
    - Replacing the wiper blade ..... 103
    - Switching on/off ..... 102
  - Rear-compartment seat belt status indicator** ..... 43
  - Rear-view mirror**
    - Dipping (manual) ..... 90
  - Recycling**
    - see Protection of the environment
  - Refuelling**
    - Fuel gauge ..... 155
    - Important safety notes ..... 136
    - Refuelling process ..... 136
    - see Fuel
  - Replacing bulbs**
    - Important safety notes ..... 97
    - Overview of bulb types ..... 97
    - Removing/replacing the cover  
(front wheel arch) ..... 98
  - Replacing the bulb**
    - Interior lighting ..... 101
    - Turn signals ..... 99
  - Rescue card** ..... 22
  - Reserve (fuel tank)**
    - see Fuel
  - Reserve fuel**
    - Display message ..... 181
  - Restraint system**
    - Display message ..... 174
    - Introduction ..... 38
    - Warning lamp ..... 191
    - Warning lamp (function) ..... 38
  - Rev counter** ..... 156
  - Reverse gear**
    - Engaging (manual transmission) .. 128
  - Reversing camera**
    - Cleaning instructions ..... 223
    - Function/notes ..... 149
    - Switching on/off ..... 150
  - Reversing feature**
    - Side windows ..... 76
  - Reversing lamp**
    - Changing bulbs ..... 100
  - Roller sunblinds for panoramic roof**
    - Operating ..... 81
  - Roof**
    - see Panoramic roof

- Roof lining and carpets (cleaning instructions)** ..... 225
- S**
- Safety**
- Child restraint systems ..... 48
  - Children in the vehicle ..... 47
  - see Operating safety
- Safety system**
- see Driving safety systems
- Seat**
- Folding passenger seat down ..... 86
  - Folding the backrest (rear compartment) forwards/back ..... 206
- Seat belt**
- Correct usage ..... 41
- Seat belts**
- Adjusting the height ..... 42
  - Cleaning ..... 225
  - Fastening ..... 42
  - Important safety guidelines ..... 40
  - Introduction ..... 40
  - Rear seat belt status indicator .... 43
  - Releasing ..... 42
  - Warning lamp ..... 190
  - Warning lamp (function) ..... 43
- Seat cushions**
- Rotating (rear seats) ..... 207
- Seats**
- Adjusting (manually) ..... 86
  - Cleaning the cover ..... 224
  - Correct driver's seat position .... 84
  - Important safety notes ..... 85
  - Seat heating problem ..... 89
  - Switching seat heating on/off ..... 88
- Sensors (cleaning instructions)** ..... 223
- Service Centre**
- see Qualified specialist workshop
- Service cover** ..... 216
- Service display**
- Calling up (on-board computer with colour display) ..... 162
  - Calling up (on-board computer with monochrome display) ..... 158
  - Hiding a service message ..... 219
  - Notes ..... 218
  - Resetting ..... 219
- Service message ..... 218
  - Showing a service message ..... 219
  - Special service requirements ..... 220
- Service products**
- Brake fluid ..... 272
  - Coolant (engine) ..... 272
  - Engine oil ..... 271
  - Fuel ..... 269
  - Important safety notes ..... 268
  - Washer fluid ..... 273
- Setting the air distribution** ..... 113
- Setting the airflow** ..... 114
- Shifting to neutral (manual transmission)** ..... 127
- Side lamps**
- Switching on/off ..... 94
- Side window**
- Hinged window ..... 78
- Side windows**
- Important safety notes ..... 76
  - Opening/closing ..... 77
  - Problem (malfunction) ..... 79
  - Resetting ..... 78
- smart Centre**
- see Qualified specialist workshop
- Snow chains** ..... 251
- Sockets**
- Centre console ..... 212
  - General notes ..... 212
- Speakers**
- see Subwoofer
- Specialist workshop** ..... 21
- Speed limiter**
- Activating ..... 147
  - Important safety notes ..... 147
  - Setting limit speed ..... 147
- Speedometer**
- Digital ..... 154
  - In the Instrument cluster ..... 154
  - see Instrument cluster
- SRS (Supplemental Restraint System)**
- see Restraint system
- Start/stop function**
- see Automatic start/stop system
- Starting (engine)** ..... 121
- Starting the engine**
- see Starting (engine)

**Steering**

- Display message (colour display) ..... 186
- Warning lamps ..... 200

**Steering wheel**

- Adjusting (manually) ..... 89
- Button overview ..... 31
- Cleaning ..... 224
- Gearshift paddles ..... 133
- Important safety notes ..... 89

**Stowage areas** ..... 204**Stowage compartment**

- Door stowage compartment ..... 205

**Stowage compartments**

- Centre console ..... 205
- Cup holder ..... 209
- Glove compartment ..... 205
- Important safety information ..... 204
- Rear ..... 206

**Submenu**

- Ambient lighting ..... 166

**Subwoofer**

- Fitting/removing ..... 209

**Summer tyres**

- In winter ..... 250

**Sun visor** ..... 211**T****Tailgate**

- Emergency unlocking ..... 76
- Important safety notes ..... 75
- Opening dimensions ..... 273
- Opening/closing ..... 75
- Warning lamp ..... 200

**Tank**

- see Fuel tank

**Technical data**

- Capacities ..... 268
- Information ..... 266
- Tyres/wheels ..... 260
- Vehicle data ..... 273

**Temperature**

- Coolant ..... 162
- Outside temperature ..... 155
- Setting (climate control) ..... 113
- Setting the display units ..... 166

**Time**

- Setting (on-board computer with colour display) ..... 163
- Setting (on-board computer with monochrome display) ..... 158
- Setting the time format (on-board computer with colour display) ..... 164

**TIREFIT kit** ..... 230**Tool**

- see Vehicle tool kit

**Top Tether** ..... 50**Total distance recorder**

- Colour display ..... 160
- Monochrome display ..... 157
- Setting the display unit ..... 165

**Tow-starting**

- Emergency engine starting ..... 240
- Important safety notes ..... 238

**Towing**

- Important safety notes ..... 238
- With the rear axle raised ..... 240

**Towing away**

- Fitting the towing eye ..... 239
- Removing the towing eye ..... 240
- With both axles on the ground ..... 240

**Transmission**

- see Automatic transmission
- see Manual transmission

**Transmission position display** ..... 129**Transporting the vehicle** ..... 240**Trip computer (colour display)** ..... 160**Trip meter**

- Colour display ..... 160
- Displaying (on-board computer with colour display) ..... 160
- Displaying (on-board computer with monochrome display) ..... 158
- Resetting (on-board computer with colour display) ..... 160
- Resetting (on-board computer with monochrome display) ..... 158
- Setting the display unit ..... 165

**Trip meter**

- see Trip meter

**Turn signals**

- Changing bulbs (front) ..... 98
- Changing bulbs (rear) ..... 100

Replacing the bulb .....	99
Switching on/off .....	95
<b>Turn signals</b>	
see Turn signals	
<b>Two-way radio</b>	
Frequencies .....	266
Installation .....	266
Transmission output (maximum) ..	266
<b>Type identification plate</b>	
see Vehicle identification plate	
<b>Tyre pressure</b>	
Display message .....	184
Important safety notes .....	253
Not reached (TIREFIT) .....	231
Reached (TIREFIT) .....	231
Recommended .....	251
<b>Tyre pressure monitor</b>	
Display message (monochrome display) .....	171
Function/notes .....	253
General notes .....	253
Important safety notes .....	253
Restarting (on-board computer with colour display) .....	254
Restarting (on-board computer with monochrome display) .....	254
Warning lamp .....	198
Warning message .....	254
<b>Tyres</b>	
Changing a wheel .....	255
Checking .....	249
Direction of rotation .....	256
Display message .....	184
General notes .....	260
Important safety notes .....	248
M+S tyres (winter tyres) .....	250
Replacing .....	255
Service life .....	249
Snow chains .....	251
Storing .....	256
Summer tyres in winter .....	250
Tyre size (data) .....	260
Tyre tread .....	249
Wheel and tyre combinations .....	261
see Flat tyre	

## U

### Unlocking

Emergency unlocking .....	74
From inside the vehicle (central unlocking button) .....	73

## V

### Vehicle

Correct use .....	21
Data acquisition .....	22
Electronic malfunction (display message) .....	189
Electronic malfunction (warning lamp) .....	200
Electronics .....	266
Equipment .....	19
Implied warranty .....	22
Leaving parked up .....	140
Locking (in an emergency) .....	74
Locking (key) .....	69
Lowering .....	259
Pulling away .....	122
Raising .....	257
Registration .....	21
Securing from rolling away .....	256
Tow-starting .....	238
Towing away .....	238
Transporting .....	240
Unlocking (in an emergency) .....	74
Unlocking (key) .....	69
Vehicle data .....	273

### Vehicle battery

  see Battery (vehicle)

### Vehicle data .....

273

### Vehicle dimensions .....

273

### Vehicle emergency locking .....

74

### Vehicle identification number

  see VIN

### Vehicle identification plate .....

267

### Vehicle key

  see Key

### Vehicle tool kit .....

229

### Ventilation

  see Climate control

### VIN .....

267

## W

**Warning and indicator lamps**

ABS .....	193
Airbag .....	191
Automatic Start/Stop function (green) .....	201
Automatic Start/Stop function (yellow) .....	201
Battery .....	196
Brakes .....	191
Distance warning function (red) ..	195
Distance warning function (yel- low) .....	194
Door .....	200
EBD .....	192
Electronics .....	200
ESP® .....	193
Lane Keeping Assist (colour display) .....	182
Lane Keeping Assist (mono- chrome display) .....	171
Oil pressure .....	197
Overview (colour display) .....	30
Overview (monochrome display) ...	28
Parking brake .....	191
PASSENGER AIR BAG .....	39
Seat belt .....	190
Steering .....	200
Tyre pressure monitor .....	198
<b>Warning triangle</b> .....	228

**Wheel and tyre combinations**

see Tyres

<b>Wheel bolt tightening torque</b> .....	259
---	-----

**Wheels**

Changing a wheel .....	255
Changing/replacing .....	255
Checking .....	249
Cleaning .....	222
Fitting a new wheel .....	259
Fitting a wheel .....	256
General notes .....	260
Important safety notes .....	248
Removing a wheel .....	258
Snow chains .....	251
Storing .....	256
Tightening torque .....	259
Wheel size/tyre size .....	260

**Windows**

Cleaning .....	222
see Side windows	

**Windscreen**

Demisting .....	114
-----------------	-----

**Windscreen**

see Windscreen

**Windscreen washer fluid**

see Windscreen washer system

**Windscreen washer system**

Important safety notes .....	273
Topping up .....	218

**Windscreen wipers**

Intermittent wipe .....	102
Problem (malfunction) .....	105
Rear window wiper .....	102
Replacing the wiper blades .....	102
Switching on/off .....	101

**Winter driving**

General notes .....	250
---------------------	-----

**Winter operation**

Slippery road surfaces .....	144
Snow chains .....	251

**Winter tyres**

M+S tyres .....	250
-----------------	-----

**Wiper blades**

Cleaning .....	222
Important safety notes .....	102
Replacing (on the rear window) ...	103
Replacing (windscreen) .....	103

**Workshop**

see Qualified specialist workshop

## Protection of the environment

### General notes

#### Environmental note

Daimler's declared policy is one of comprehensive environmental protection.

The objective is to use the natural resources which form the basis of our existence on this planet sparingly and in a manner which takes the requirements of both nature and humanity into account.

You too can help to protect the environment by operating your vehicle in an environmentally-responsible manner.

Fuel consumption and the rate of engine, transmission, brake and tyre wear depend on the following factors:

- the operating conditions of your vehicle
- your personal driving style

You can influence both factors. You should bear the following in mind:

Operating conditions:

- avoid short trips as these increase fuel consumption.
- make sure that the tyre pressures are always correct.
- do not carry any unnecessary weight.
- a regularly serviced vehicle will contribute to environmental protection. You should therefore adhere to the service intervals.
- always have service work carried out at a qualified specialist workshop.

Personal driving style:

- do not depress the accelerator pedal when starting the engine.
- do not warm up the engine with the vehicle stationary.
- drive carefully and maintain a suitable distance from the vehicle in front.
- avoid frequent, sudden acceleration and braking.

- change gear in good time and use each gear only up to  $\frac{2}{3}$  of its maximum engine speed.
- switch off the engine in stationary traffic.
- keep an eye on the vehicle's fuel consumption.

### Returning an end-of-life vehicle

EU countries only:

smart will take back your old vehicle to dispose of it in an environmentally-responsible manner in accordance with the European Union (EU) End of Life Vehicles Directive.

There is a network of return points and disassembly plants available. In these plants you can return your vehicle free of charge. This makes a valuable contribution to the recycling process and the conservation of resources.

For further information on recycling old vehicles, recovery and the terms of the policy, visit the smart homepage.

### Genuine smart parts

#### Environmental note

Daimler AG also supplies reconditioned assemblies and parts which are of the same quality as new parts. For these, the same warranty applies as for new parts.

 Airbags and seat belt tensioners, as well as control units and sensors for these restraint systems, may be installed in the following areas of your vehicle:

- doors
- door pillars
- door sills
- seats
- dashboard

- instrument cluster
- centre console

Do not install accessories such as audio systems in these areas. Do not carry out repairs or welding. You could impair the operating efficiency of the restraint systems.

Have accessories retrofitted at a qualified specialist workshop.

You could jeopardise the operating safety of your vehicle if you use parts, tyres and wheels as well as accessories relevant to safety which have not been approved by smart. This could lead to malfunctions in safety-relevant systems, e.g. the brake system. Use only genuine smart parts or parts of equal quality. Only use tyres, wheels and accessories that have been specifically approved for your vehicle.

smart tests genuine parts and conversion parts and accessories that have been specifically approved for your vehicle for their reliability, safety and suitability. Despite ongoing market research, smart is unable to assess other parts. smart therefore accepts no responsibility for the use of such parts in smart vehicles, even if they have been officially approved or independently approved by a testing centre.

In Germany, certain parts are only officially approved for installation or modification if they comply with legal requirements. This also applies to some other countries. All genuine smart parts meet the approval requirements. The use of non-approved parts may invalidate the vehicle's general operating permit.

This is the case:

- if they cause a change of the vehicle type from that for which the vehicle's general operating permit was granted
- if other road users could be endangered
- if the emission or noise levels are adversely affected

Always specify the vehicle identification number (VIN) (▷ page 267) when ordering genuine smart parts.

## Owner's Manual

### Vehicle equipment

This Owner's Manual describes all models and all standard and optional equipment available for your vehicle at the time of publication of the Owner's Manual. Country-specific differences are possible. Note that your vehicle may not be fitted with all features described. This is also the case for systems and functions relevant to safety. Therefore, the equipment on your vehicle may differ from that in the descriptions and illustrations.

The original purchase contract documentation for your vehicle contains a list of all of the systems in your vehicle.

Should you have any questions concerning equipment and operation, please consult a smart Centre.

The Owner's Manual and Service Booklet are important documents and should be kept in the vehicle.

## Operating safety

### Important safety notes

#### **WARNING**

If you do not have the prescribed service/maintenance work or necessary repairs carried out, this could result in malfunctions or system failures. There is a risk of an accident.

Always have the prescribed service/maintenance work as well as necessary repairs carried out at a qualified specialist workshop.

**⚠ WARNING**

Flammable material such as leaves, grass or twigs may ignite if they come into contact with hot parts of the exhaust system. There is a risk of fire.

When driving off road or on unpaved roads, check the vehicle's underside regularly. In particular, remove parts of plants or other flammable materials which have become trapped. In the case of damage, contact a qualified specialist workshop.

**⚠ WARNING**

Modifications to electronic components, their software as well as wiring could affect their function and/or the operation of other networked components. This could in particular also be the case for systems relevant to safety. They might not function properly anymore and/or jeopardise the operational safety of the vehicle. There is an increased risk of an accident and injury. Do not attempt to modify the wiring as well as electronic components or their software. Always have work on electrical and electronic components carried out at a qualified specialist workshop.

If you make any changes to the vehicle electronics, the general operating permit is rendered invalid.

**!** There is a risk of damage to the vehicle if:

- the vehicle becomes stuck, e.g. on a high kerb or an unpaved road
- you drive too fast over an obstacle, e.g. a kerb or a pothole in the road
- a heavy object strikes the underbody or parts of the chassis

In situations like this, the body, the underbody, chassis parts, wheels or tyres could be damaged without the damage being visible. Components damaged in this way can unexpectedly fail or, in the case of an accident, no longer withstand the strain they are designed for.

If the underbody panelling is damaged, combustible materials such as leaves, grass or twigs can gather between the underbody and the underbody panelling. If these materials come in contact with hot parts of the exhaust system, they can catch fire.

In such situations, have the vehicle checked and repaired immediately at a qualified specialist workshop. If, upon continuing your journey, you notice that driving safety is impaired, pull over and stop the vehicle immediately, paying attention to road and traffic conditions. In such cases, consult a qualified specialist workshop.

## Declarations of conformity

### Wireless vehicle components

The following information applies to all components of the vehicle and the information systems and communication devices integrated into the vehicle which receive and/or transmit radio waves:

The components of this vehicle that receive and/or transmit radio waves are compliant with the essential requirements and all other relevant conditions of Directive 1999/5/EC. For further information enquire at any smart centre.

### Electromagnetic compatibility

The electromagnetic compatibility of the vehicle components has been checked and certified according to the currently valid version of Regulation ECE-R 10.

### Diagnostics connection

The diagnostics connection is only intended for the connection of diagnostic equipment at a qualified specialist workshop.

**⚠ WARNING**

If you connect equipment to a diagnostics connection in the vehicle, it can affect the operation of the vehicle systems. This may affect the operating safety of the vehicle. There is a risk of an accident.

Do not connect any equipment to a diagnostics connection in the vehicle.

**⚠ WARNING**

Objects in the driver's footwell may restrict the clearance around the pedals or block a depressed pedal. This jeopardises the operating and road safety of the vehicle. There is a risk of an accident.

Stow all objects securely in the vehicle so that they do not get into the driver's footwell. Always fit the floormats securely and as prescribed in order to ensure that there is always sufficient room for the pedals. Do not use loose floormats and do not place several floormats on top of one another.

**!** If the engine is switched off and equipment on the diagnostics connection is used, the starter battery may discharge.

Connecting equipment to the diagnostics connection can lead to emissions monitoring information being reset, for example. This may lead to the vehicle failing to meet the requirements of the next emissions test during the main inspection.

**Qualified specialist workshop**

A qualified specialist workshop has the necessary special skills, tools and qualifications to correctly carry out any necessary work on your vehicle. This particularly applies to work relevant to safety.

Observe the notes in the Service Booklet.

Always have the following work carried out at a qualified specialist workshop:

- work relevant to safety
- service and maintenance work

- repair work
- modifications, installations and conversions
- work on electronic components

smart recommends that you use a smart centre.

**Vehicle registration**

smart may ask its smart centres to carry out technical inspections on certain vehicles. The quality or safety of the vehicle is improved as a result of the inspection.

smart can only inform you about vehicle checks if it has your registration data.

It is possible that your vehicle has not yet been registered in your name in the following cases:

- if your vehicle was not purchased at an authorised specialist dealer.
- if your vehicle has not yet been examined at a smart centre.

It is advisable to register your vehicle with a smart centre.

Inform smart as soon as possible about any change in address or vehicle ownership. You can do this at a smart centre, for example.

**Correct use**

If you remove any warning stickers, you or others could fail to recognise certain dangers. Leave warning stickers in position.

Observe the following information when driving your vehicle:

- the safety notes in this manual
- the technical data in this manual
- traffic rules and regulations
- laws and safety standards pertaining to motor vehicles

### Implied warranty

**!** Follow the instructions in this manual about the proper operation of your vehicle as well as about possible vehicle damage. Damage to your vehicle that arises from culpable contraventions against these instructions is not covered either by the smart implied warranty or by the New or Used-Vehicle Warranty.

### QR codes for rescue card

The QR code is secured in the fuel filler flap and on the opposite side on the B-pillar. In the event of an accident, rescue services can use the QR code to quickly find the appropriate rescue card for your vehicle. The current rescue card contains, in a compact form, the most important information about your vehicle, e.g. the routing of the electric cables.

You can find more information under [http://portal.aftersales.i.daimler.com/public/content/asportal/en/communication/informationen\\_fuer/QRCode.html](http://portal.aftersales.i.daimler.com/public/content/asportal/en/communication/informationen_fuer/QRCode.html).

### Data stored in the vehicle

A large number of your vehicle's electronic components can store data.

The data memory temporarily or permanently stores technical information about:

- the vehicle's operating state
- events
- faults

The technical information generally documents the condition of a component, module, system or the environment.

These include, for example:

- The operating status of system components, e.g. fluid levels
- Status messages concerning the vehicle and its individual components, e.g. number of wheel revolutions/speed, deceleration in movement, lateral acceleration, accelerator pedal position
- Malfunctions and defects in key system components, including, for instance, lights, brakes.
- Vehicle reactions and operating conditions in special driving situations, including, for instance, deployment of an airbag, use of stability control systems.
- Environmental conditions, including, for instance, the outside temperature.

This data is of an exclusively technical nature and can be used to:

- assist in the detection and elimination of faults and defects
- analyse vehicle functions, e.g. after an accident
- optimise vehicle functions

The data cannot be used to trace the vehicle's movements.

If you have the vehicle serviced, this technical information can be read out from the event and fault data memory.

Services include, for example, information on:

- repair work
- service work
- warranty claims
- quality assurance

The readout is handled by service network staff (including the manufacturer) with the help of special diagnostic testers. You can obtain more detailed information, if required.

After the fault has been rectified, the information is cleared in the fault memory or is sequentially overwritten.

During vehicle operation, certain situations may arise in which this technical data - in conjunction with other information and, if applicable, after consultation with an approved assessor - may be linked to an individual person.

Examples of this include:

- accident reports
- vehicle damage
- evidence

### Copyright information

### General notes

You can find information on licences for free and open-source software used in your vehicle and its electronic components on the following website:

<http://www.mercedes-benz.com/opensource>



Cockpit .....	26
Instrument cluster with monochrome display .....	27
Instrument cluster with colour display .....	29
Multifunction steering wheel .....	31
Centre console .....	33
Overhead control panel .....	34
Door control panel .....	35

## Cockpit

&gt;&gt; At a glance.

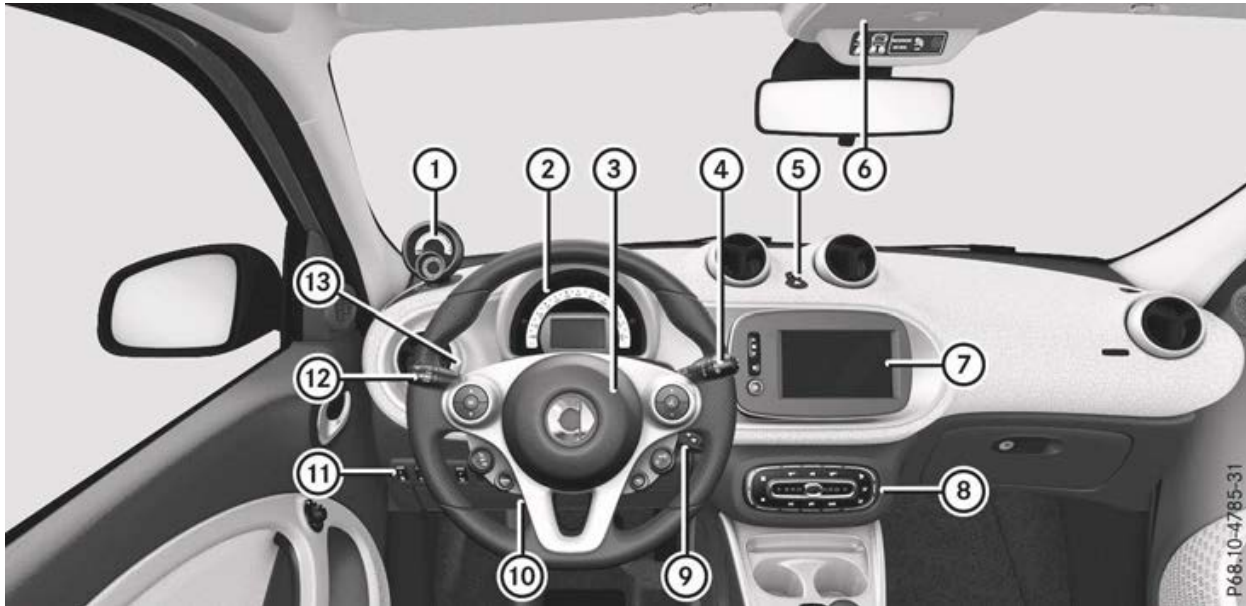

	Function	Page
①	Additional instruments on the dashboard	156
②	Instrument cluster	29
③	Horn	
④	Multifunction lever On-board computer Windscreen wipers combination switch	156 101
⑤	Locks/unlocks the vehicle centrally Switches the hazard warning lamps on/off	73 96
⑥	Overhead control panel	34
⑦	smart Audio-System/ smart Media-System (see the separate operating instructions)	
⑧	Climate control system control panel	108

	Function	Page
⑨	Ignition lock	121
⑩	Adjusts the steering wheel	89
⑪	Control panel for: <input type="checkbox"/> (A) Turning the automatic start/stop system on/off Turning Lane Keeping Assist on/off Turning the forward collision warning on/off Turning the parking aid on/off Headlamp range adjustment	125 151 62 148 94
⑫	Lights combination switch	93
⑬	Gearshift paddles	133

## Instrument cluster with monochrome display

## Displays



P54.33-4085-31

**i** Instrument cluster with speedometer

	Function	Page
①	Speedometer	154
②	Monochrome display	157
③	Warning and indicator lamps	28

>> At a glance.

&gt;&gt; At a glance.

## Warning and indicator lamps

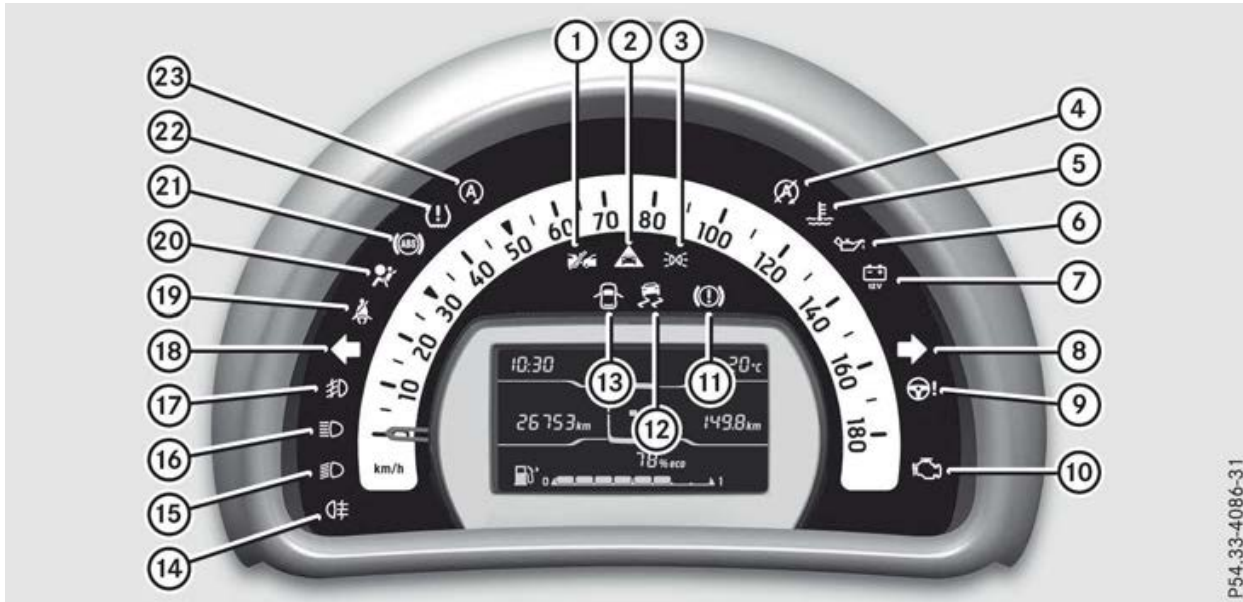

P54.33-4086-31

	Function	Page		Function	Page
①	Distance warning function	194	⑬	Doors or the tailgate Vehicle electronics	200 200
②	Distance warning signal	195	⑭	Rear foglamp	94
③	Side lamps	94	⑮	Dipped-beam headlamps	94
④	Automatic start/stop function Conditions for the automatic engine switch-off not met Malfunction	123 201	⑯	Main-beam headlamps	95
⑤	Coolant temperature	197	⑰	Foglamps	94
⑥	Oil pressure	197	⑱	Turn signal, left	95
⑦	Battery	196	⑲	Seat belts	190
⑧	Turn signal, right	95	⑳	Restraint system	191
⑨	Power steering	200	㉑	ABS	193
⑩	Engine diagnostics	196	㉒	Tyre pressure monitor	198
⑪	Brakes	191	㉓	Automatic start/stop function Automatic start/stop function	124
⑫	esp®	193			

## Instrument cluster with colour display

## Displays



P54.33-4087-31

**i** Instrument cluster with speedometer

	Function	Page
①	Speedometer	154
②	Colour display	159
③	Warning and indicator lamps	30

>> At a glance.

&gt;&gt; At a glance.

## Warning and indicator lamps



P54.33-4088-31

	Function	Page
①	Automatic start/stop function Conditions for the automatic engine switch-off not met Malfunction	123 201
②	Automatic start/stop function Automatic start/stop function	124
③	ABS	193
④	esp®	193
⑤	Battery	196
⑥	Tyre pressure monitor	198
⑦	Oil pressure	197
⑧	Power steering	200
⑨	Engine diagnostics	196
⑩	Coolant temperature	197

	Function	Page
⑪	Turn signal, right	95
⑫	Turn signal, left	95
⑬	Brakes	191
⑭	Rear foglamp	94
⑮	Foglamps	94
⑯	Main-beam headlamps	95
⑰	Dipped-beam headlamps	94
⑱	Restraint system	38
⑲	Side lamps	94
⑳	Distance warning signal	195
㉑	Seat belts	190
㉒	Doors or the tailgate Vehicle electronics	200 200

Multifunction steering wheel

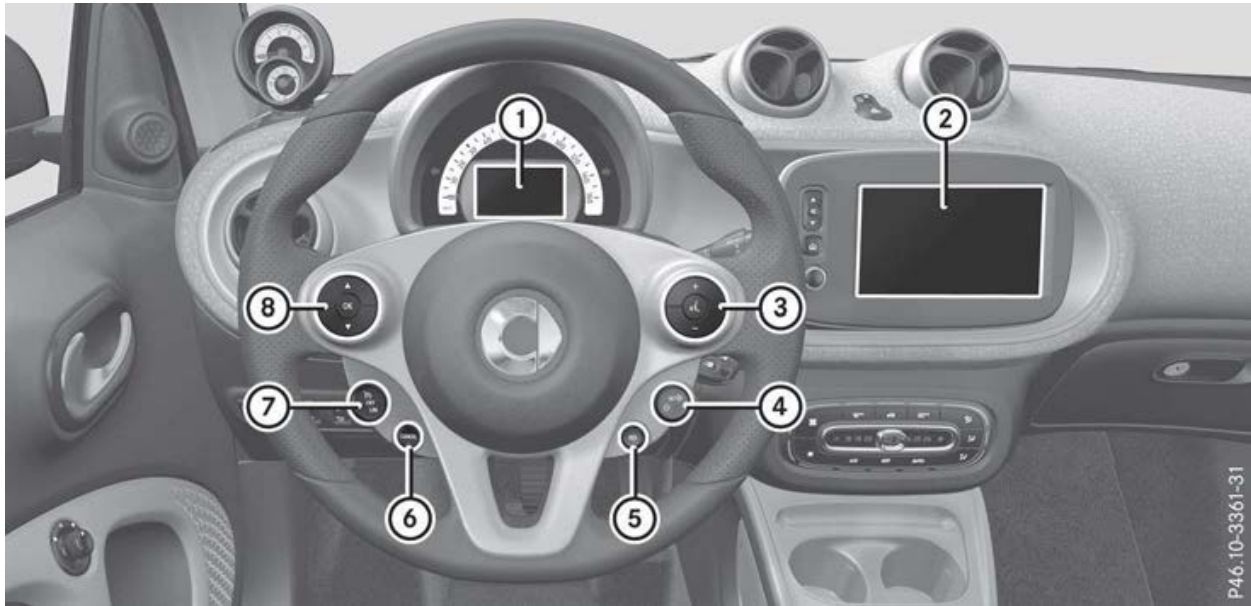

>> At a glance.

	Function	Page
①	Colour display in instrument cluster Monochrome display in instrument cluster	29 27
②	smart Audio-System or smart Media-System display (see the separate operating instructions)	
③	<p><input type="checkbox"/> <input type="checkbox"/> Changes the volume of the smart Audio-System/smart Media-System (see the separate operating instructions)</p> <p>Only with an instrument cluster with colour display:</p> <p><input type="checkbox"/> Switches voice-operated control of the smart Audio-System on/off and accepts/ends a call (see the separate operating instructions)</p>	

	Function	Page
④	<p>Cruise control and limiter button:</p> <p><input type="checkbox"/> SET + Increases or stores the current speed</p> <p>- Decreases current speed</p> <ul style="list-style-type: none"> <li>• Cruise control</li> <li>• Limiter</li> </ul>	145
⑤	<p>Cruise control and limiter button:</p> <p><input type="checkbox"/> RES Calls up the last speed stored</p> <ul style="list-style-type: none"> <li>• Cruise control</li> <li>• Limiter</li> </ul>	145
⑥	<p>Cruise control and limiter button:</p> <p><input type="checkbox"/> CANCEL Interrupts cruise control or the limiter</p> <ul style="list-style-type: none"> <li>• Cruise control</li> <li>• Limiter</li> </ul>	145

>> At a glance.

	Function	Page
⑦	Cruise control and limiter switch: <input type="checkbox"/> Activates cruise control <input type="checkbox"/> Deactivates cruise control or the limiter <input type="checkbox"/> Activates limiter <ul style="list-style-type: none"> <li>• Cruise control</li> <li>• Limiter</li> </ul>	145

	Function	Page
⑧	Only with an instrument cluster with colour display: <input type="checkbox"/> <input type="checkbox"/> Scrolls through a menu or list <input type="checkbox"/> Confirms a selection Changes to the "Reset values" function in certain menus Hides display messages	159 159 159 173

**i** Voice-operated control as well as control of the telephone and volume using the steering wheel buttons in the control panel on the right ③ only function with the smart Media-System. If you use a smart Audio-System or an audio device from another manufacturer, the functions may be restricted or not available at all.

## Centre console

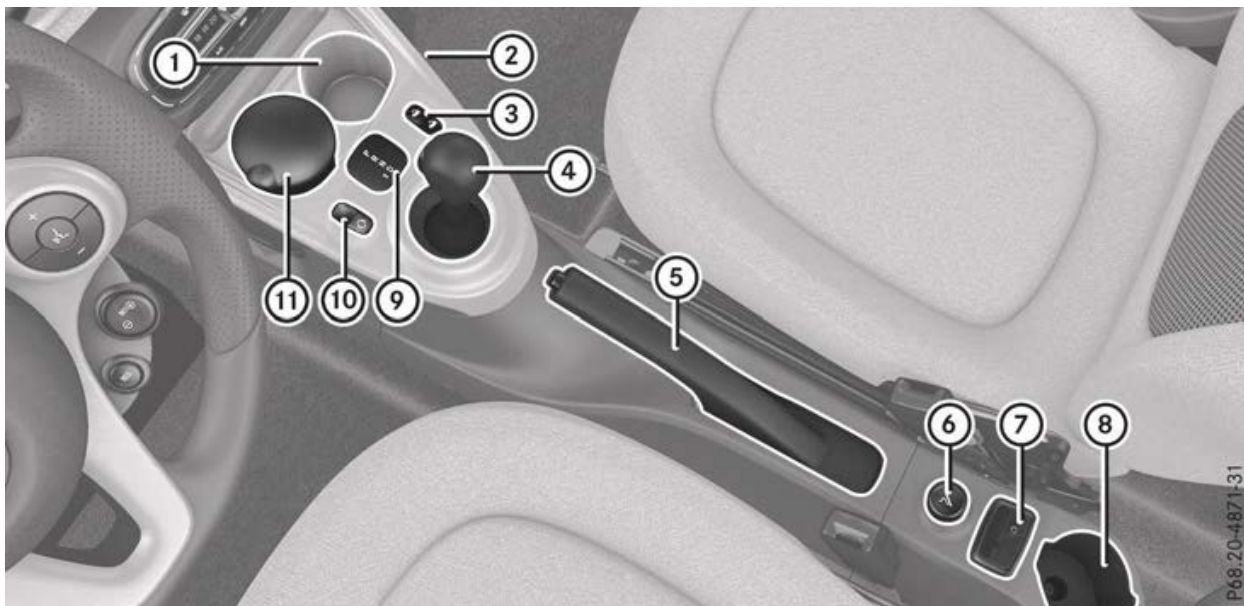

&gt;&gt; At a glance.

	Function	Page		Function	Page
①	Cup holders	209	⑦	AUX/USB port and SD memory card (only with smart Media-System)	
②	Drawer	205	⑧	Cup holders	210
③	Opens/closes the folding top Coin holder	80	⑨	Transmission position display	130
④	Selector lever	129	⑩	Sets the driving program (program selector button)	131
⑤	Parking brake	139	⑪	Ashtray (vehicles with smoker's package)	211
⑥	Cigarette lighter (vehicles with smoker's package) Power socket	211 212			

## Overhead control panel

&gt;&gt; At a glance.

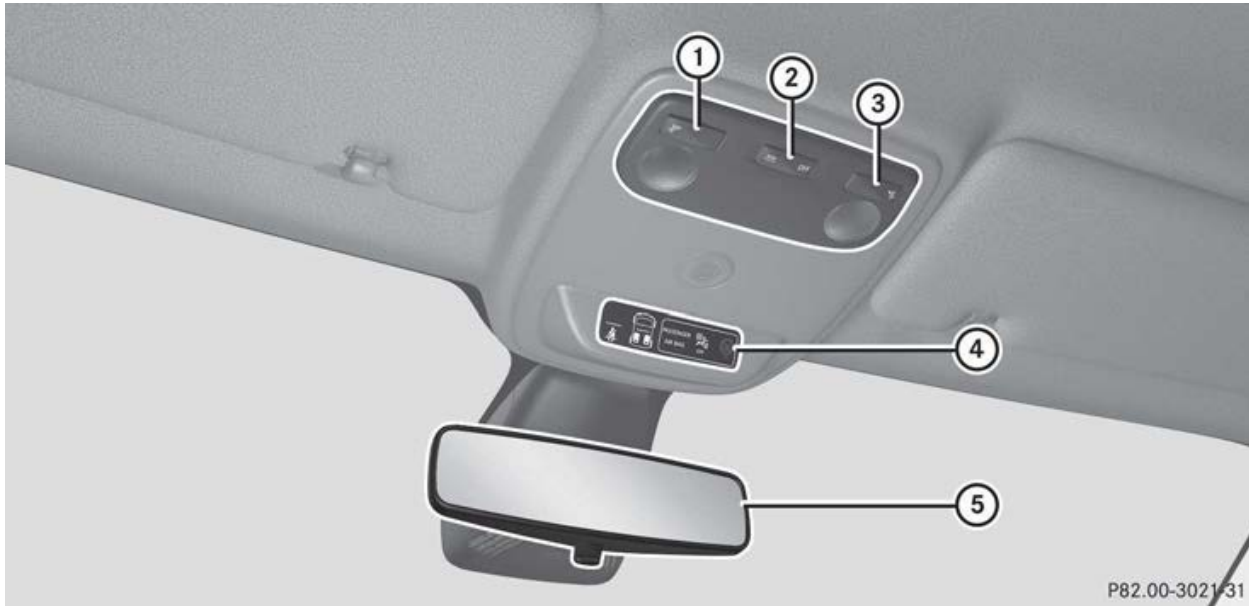

P82.00-3021-31

	Function	Page
①	Switches the left-hand reading lamp on/off	96
②	Depending on the position of the switch: Interior lighting switched on	96
	Automatic interior lighting control on	96
	Interior lighting switched off	96

	Function	Page
③	Switches the right-hand reading lamp on/off	96
④	PASSENGER AIRBAG OFF/ON indicator lamps Rear seat belt status indicator	39 43
⑤	Rear-view mirror	90

## Door control panel



	Function	Page
①	Opens the door	72
②	Adjusts the exterior mirrors electrically	90

	Function	Page
③	 Opens/closes the side windows	76

>> At a glance.



Useful information .....	38
Occupant safety .....	38
Children in the vehicle .....	47
Child-proof locks .....	59
Pets in the vehicle .....	60
Protection against theft .....	60
Driving safety systems .....	61

### Useful information

- i** This Owner's Manual describes all models, series and optional equipment for your vehicle that were available at the time of going to press. Country-specific differences are possible. Note that your vehicle may not be fitted with all features described. This is also the case for systems and functions relevant to safety.
- i** Read the information on qualified specialist workshops: (▷ page 21).

## Occupant safety

### Introduction to the restraint system

The restraint system can reduce the risk of vehicle occupants coming into contact with parts of the vehicle's interior in the event of an accident. The restraint system can also reduce the forces to which vehicle occupants are subjected during an accident.

The restraint system includes the:

- Seat belt system
- Airbags
- Child restraint system
- Child seat securing system

The components of the restraint system work in conjunction with each other. They can only offer protection if all vehicle occupants always:

- have the seat belt correctly fastened (▷ page 41)
- have the seat adjusted properly (▷ page 85)

As the driver, you must also make sure that the steering wheel is also adjusted properly. Observe the information on the correct driver's seat position (▷ page 84).

In addition, you must make sure that the airbags can inflate properly if they are deployed (▷ page 44).

An airbag supplements a correctly worn seat belt. The airbag, as an additional safety device, increases protection for vehicle occupants in applicable accident situations. The airbags are not deployed, for example, in the event of an accident in which sufficient protection is offered by the seat belt. In addition, only those airbags, which in the applicable accident situations offer additional protection, are deployed in the event of an accident. However, the seat belt and airbag generally do not protect against objects penetrating the vehicle from the outside.

Information on how the restraint system operates can be found under "Deployment of belt tensioners and airbags" (▷ page 46). See "Children in the vehicle" for further information on children travelling in the vehicle as well as on child restraint systems (▷ page 47).

### Important safety notes

#### WARNING

If the restraint system is modified, it may no longer work as intended. The restraint system may then not perform its intended protective function by failing in an accident or triggering unexpectedly, for example. There is an increased risk of injury, possibly even fatal.

Never modify parts of the restraint system. Do not attempt to modify the wiring as well as electronic components or their software.

If it is necessary to modify an airbag system to accommodate a person with disabilities, contact a smart centre.

### Restraint system warning lamp

The functions of the restraint system are checked after the ignition is switched on and at regular intervals while the engine

is running. Therefore, malfunctions can be detected in good time.

The  restraint system warning lamp in the instrument cluster lights up when the ignition is switched on. It goes out no later than a few seconds after the engine is started. The components of the restraint system are in operational readiness.

A malfunction has occurred if the  restraint system warning lamp:

- does not light up after the ignition is switched on
- does not go out after a few seconds with the engine running
- lights up again while the engine is running

#### WARNING

If the restraint system is malfunctioning, restraint system components may be triggered unintentionally or might not be triggered at all in the event of an accident with a high rate of vehicle deceleration. This can affect belt tensioners or airbags, for example. There is an increased risk of serious or even fatal injuries.

Have the restraint system checked and repaired immediately at a qualified specialist workshop.

#### PASSENGER AIR BAG indicator lamps



PASSENGER AIR BAG OFF indicator lamp ① and PASSENGER AIR BAG ON indicator

lamp ② are part of the deactivation system of the front-passenger front airbag.

The indicator lamps display the status of the front-passenger front airbag.

- PASSENGER AIR BAG OFF ① lights up: the front-passenger front airbag is disabled. It will then not be deployed in the event of an accident.
- PASSENGER AIR BAG ON ② lights up: the front-passenger front airbag is enabled. If, in the case of an accident, all deployment criteria are met, the front-passenger front airbag is deployed.

Depending on the person in the front-passenger seat, the front-passenger front airbag must either be disabled or enabled. You must make sure of this both before and during a journey.

#### • Children in a child restraint system:

whether the front-passenger front airbag must be enabled or disabled depends on the installed child restraint system, and the age and size of the child. Therefore, always observe the information on "Children in the vehicle" (▷ page 47). There you will also find instructions on backwards and forwards-facing child restraint systems on the front-passenger seat.

- **All other persons:** the PASSENGER AIR BAG OFF indicator lamp must be off and the PASSENGER AIR BAG ON indicator lamp must be on. The front-passenger front airbag is enabled. If the PASSENGER AIR BAG OFF indicator lamp is lit, the front-passenger front airbag is disabled. It will then not be deployed in the event of an accident. In this case, the front-passenger seat should not be used.

Be sure to observe the notes on "Activating/deactivating the front-passenger airbag" as well as "Seat belts" (▷ page 51) (▷ page 40) and "Airbags" (▷ page 43). There you can also find information on the correct seat position.

Observe the information on the airbag deactivation system of the front-passenger front airbag (> page 51).

## Seat belts

### Introduction

A correctly worn seat belt is the most effective means of restraining the movement of vehicle occupants in the event of a collision or if the vehicle overturns. This reduces the risk of vehicle occupants coming into contact with parts of the vehicle interior or being ejected from it. The seat belt also helps to keep the vehicle occupants in the best position in relation to the airbag being deployed.

The seat belt system consists of:

- seat belts
- belt tensioners and belt force limiters

If the seat belt is pulled quickly or sharply by the seat belt guide, the inertia reel locks. The belt strap cannot be pulled out any further.

The belt tensioner tightens the seat belt in the event of a collision so that it fits tightly across your body. However, it does not pull the vehicle occupants back in the direction of the seat backrest.

The belt tensioner does not, however, correct an incorrect seat position or correct the routing of a seat belt that is worn incorrectly.

When triggered, seat belt force limiters help to reduce the peak force exerted by the seat belt on the vehicle occupant.

The belt force limiters are synchronised with the front airbags, which take on a part of the deceleration force. This can reduce the forces to which the vehicle occupants are subjected during an accident.

**!** If the co-driver's seat is not occupied, do not engage the seat belt tongue in the buckle on the co-driver's seat. Other-

wise, the belt tensioner could be triggered in the event of an accident and would have to be replaced.

### Important safety notes

#### WARNING

The seat belt cannot perform its intended protective function if it is not fastened correctly. Also, an improperly fastened seat belt can cause additional injuries in the event of an accident, sudden braking or abrupt changes of direction. There is an increased risk of injury, possibly even fatal.

Always make sure that all vehicle occupants are wearing their seat belt properly and are seated correctly.

#### WARNING

The seat belt does not offer the intended level of protection if you have not moved the backrest to an almost vertical position. When braking or in the event of an accident, you could slide underneath the seat belt and sustain abdomen or neck injuries, for example. This poses an increased risk of injury or even fatal injury.

Adjust the seat properly before beginning your journey. Always ensure that the backrest is in an almost vertical position and that the shoulder section of your seatbelt is routed across the centre of your shoulder.

#### WARNING

Persons under 1.50 m tall cannot wear the seat belts correctly without a suitable, additional restraint system. The seat belt cannot perform its intended protective function if it is not fastened correctly. Also, an improperly fastened seat belt can cause additional injuries in the event of an accident, sudden braking or abrupt changes of direction. There is an increased risk of injury, possibly even fatal.

Secure persons less than 1.50 m tall in a suitable restraint system.

If a child under twelve years of age and less than 1.50 m tall is travelling in the vehicle:

- always secure the child in a child restraint system suitable for this smart vehicle.

The child restraint system must be appropriate to the age, weight and size of the child.

- always observe the instructions and safety notes on "Children in the vehicle" in this Owner's Manual (▷ page 47) in addition to the child restraint system manufacturer's installation instructions.

#### **WARNING**

Seat belts cannot protect as intended, if:

- they are damaged, have been modified, are extremely dirty, bleached or dyed
- the seat belt buckle is damaged or extremely dirty
- modifications have been made to the belt tensioners, belt anchorages or inertia reels

Seat belts may sustain non-visible damage in an accident, e.g. due to glass splinters. Modified or damaged seat belts can tear or fail, for example in the event of an accident. Modified seat belt tensioners may be deployed unintentionally or fail to be deployed when required. There is an increased risk of injury, possibly even fatal.

Never modify safety belts, seat belt tensioners, seat belt anchorages and inertia reels. Ensure that seat belts are not damaged or worn and are clean. After an accident, have the seat belts checked immediately at a qualified specialist workshop.

smart recommends that you only use seat belts which have been approved specifically for your vehicle by smart. Any such modifications could invalidate the vehicle's general operating permit.

### **Correct use of the seat belt**

Observe the safety notes on the seat belt (▷ page 40).

All vehicle occupants must be wearing the seat belt correctly before beginning the journey. Also make sure that all vehicle occupants are always wearing the seat belt correctly while the vehicle is in motion.

When fastening the seat belt, always make sure that:

- the seat belt tongue is only inserted to the belt buckle belonging to that seat.
- the seat belt is tight across your body. Avoid wearing bulky clothing, e.g. a winter coat.
- the seat belt is not twisted.

Only then can forces which occur be distributed across the surface of the seat belt.

- the shoulder section of the belt is always routed across the centre of your shoulder.

The shoulder section of the seat belt should not touch your neck nor be routed under your arm. If possible, adjust the seat belt to the appropriate height.

- the lap belt passes across your lap as tightly and as low down as possible.

The lap belt must always be routed across your hip joints and never across your abdomen. This applies particularly to pregnant women. If necessary, press the lap belt down into your hip joints and pull tight with the shoulder section of the belt.

- the seat belt is not routed across sharp, pointed or fragile objects.

If you have such items located on or in your clothing, e.g. pens, keys or spectacles, store these in a suitable place.

- only one person is using a seat belt.

Infants and children must never travel sitting on the lap of a vehicle occupant. In the event of an accident, they could be

crushed between the vehicle occupant and seat belt.

- objects are never secured with a seat belt if the seat belt is also being used by one of the vehicle's occupants.

Seat belts are only intended to secure and restrain vehicle occupants. Always observe the "Loading guidelines" for securing objects, luggage or loads (▷ page 204).

### Fastening and adjusting the seat belts

Observe the safety notes on the seat belt (▷ page 40) and the notes on correct use of seat belts (▷ page 41).



- ▶ Adjust the seat (▷ page 84). The seat backrest must be in an almost vertical position.
- ▶ Pull the seat belt smoothly from belt outlet ③ and engage belt tongue ② into belt buckle ①.
- ▶ If necessary, pull upwards on the shoulder section of the seat belt to tighten the belt across your body.



The shoulder section of the seat belt must always be routed across the centre of the shoulder. Adjust the belt outlet if necessary.

- ▶ **To raise:** slide the belt outlet up by the ring. The belt outlet will engage in various positions.
- ▶ **To lower:** hold belt guide release ④ and slide the belt outlet down by the ring.

### Releasing the seat belts

- ❗ Make sure that the seat belt is fully rolled up. Otherwise, the seat belt or belt tongue will be trapped in the door or in the seat mechanism. This could damage the door, the door trim panel and the seat belt. Damaged seat belts can no longer fulfil their protective function and must be replaced. Visit a qualified specialist workshop.



- Press release button ①, hold belt tongue ② and guide it back towards belt outlet ③.

### Belt warning for the driver and front passenger

The  seat belt warning lamp in the instrument cluster is a reminder that all vehicle occupants must wear their seat belts. It may light up continuously or flash. In addition, a warning tone may sound.

The  seat belt warning lamp goes out and the warning tone ceases when the driver and the front passenger have fastened their seat belt.

### Rear seat belt status indicator

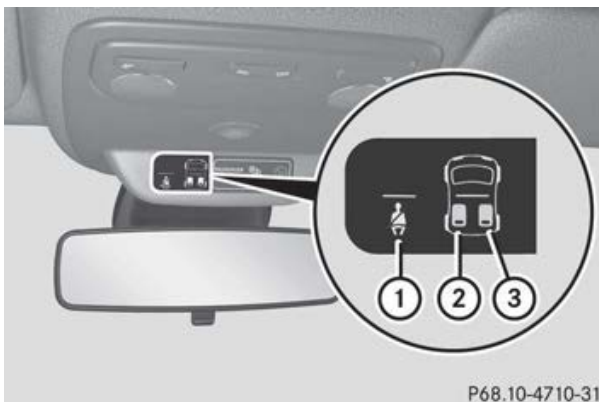

With the status indicator for the rear-compartment seat belts you can determine which rear seat belt is not fastened.

Seat belt warning lamp ① and rear seat belt status indicator ② and ③ light up when the ignition is switched on. When you drive off and have reached a speed of approximately 10 km/h the lamps go out after approximately 30 seconds. When a door is opened, the lamps light up again.

Rear seat belt status indicator ② and ③ inform you about the status of the seat belts. They always light up simultaneously, the status is indicated by the colour.

- Red: seat belt not fastened.
- Green: seat belt fastened.

Indicator ② shows the status of the left rear seat, for example.

Seat belt warning lamp ① and rear seat belt status indicator ② and ③ light up when:

- you drive off and do not exceed a speed of approximately 20 km/h and
- the rear passengers fasten or unfasten their seat belts while the vehicle is in motion.

If you drive off and a rear seat belt is unfastened after the vehicle exceeds a speed of about 20 km/h:

- seat belt warning lamp ① flashes
- rear seat belt status indicator ② and/or ③ lights up red
- a tone sounds

A rear seat does not have to be occupied.

## Airbags

### Introduction

The installation location of an airbag is identified by the AIRBAG symbol.

An airbag supplements a correctly worn seat belt. It is not a replacement for the

seat belt. The airbag offers additional protection in applicable accident situations.

Not all airbags are deployed in an accident. The different airbag systems work independently of each other (▷ page 46). However, no system available today can completely eliminate injuries and fatalities.

It is also not possible to completely rule out a risk of injury caused by an airbag due to the speed at which the airbag must be deployed.

### Important safety notes

#### WARNING

If you deviate from the correct seat position, the airbag cannot perform its intended protective function and can even cause additional injuries when deployed. There is an increased risk of serious or even fatal injuries.

In order to avoid such risks, always ensure that all vehicle occupants:

- fasten their seatbelts correctly, including pregnant women
- are seated correctly and maintain the furthest possible distance from the airbags
- observe the following notes

Always ensure that there are no objects located between the airbag and the vehicle occupant.

- Adjust the seats properly before beginning your journey. Always make sure that the seat is in an almost upright position.
- Move the driver's and front-passenger seats as far back as possible. The driver's seat position must allow the vehicle to be driven safely.
- Only hold the steering wheel on the outside. This allows the airbag to be fully deployed.

- Always lean against the backrest while driving. Do not lean forwards or lean against the door or side window. You may otherwise be in the deployment area of the airbags.
- Always keep your feet in the footwell in front of the seat. Do not put your feet on the dashboard, for example. Your feet may otherwise be in the deployment area of the airbag.
- Always secure persons less than 1.50 m tall in suitable restraint systems. Up to this height, the seat belt cannot be worn correctly.

### If a child is travelling in your vehicle, also observe the following notes:

- Always secure children under twelve years of age and less than 1.50 m tall in suitable child restraint systems.
- Child restraint systems should be fitted to the rear seats.
- Only secure a child to the front-passenger seat when the front-passenger front airbag is disabled, and only then in a rearward-facing child restraint system. If the PASSENGER AIR BAG OFF indicator lamp is permanently lit, the front-passenger front airbag is disabled (▷ page 39).
- Always observe the instructions and safety notes on "Children in the vehicle" (▷ page 47) and on the "Child restraint system on the front-passenger seat" (▷ page 52) in addition to the child restraint system manufacturer's installation instructions.

**Objects in the vehicle interior may prevent the airbag from functioning correctly.** Before starting your journey and to avoid risks resulting from the speed of the airbag as it deploys, make sure that:

- there are no people, animals or objects between the vehicle occupants and an airbag.
- there are no objects between the seat, the door and the door pillar (B-pillar).
- no hard objects, e.g. coat hangers, are hanging on the grab handles or coat hooks.
- no accessories, such as cup holders, are attached to the vehicle within the deployment area of an airbag, e.g. to doors or side windows.
- no heavy, sharp-edged or fragile objects are in the pockets of your clothing. Store such objects in a suitable place.

**⚠ WARNING**

If you modify an airbag cover or affix objects such as stickers to it, the airbag can no longer function correctly. There is an increased risk of injury.

Never modify an airbag cover or affix objects to it.

**⚠ WARNING**

Sensors to control the airbags are located in the doors. Modifications or work not performed correctly to the doors or door panelling, as well as damaged doors, can lead to the function of the sensors being impaired. The airbags might therefore not function properly any more. Consequently, the airbags cannot protect vehicle occupants as they are designed to do. This poses an increased risk of injury.

Never modify the doors or parts of the doors. Always have work on the doors or door panelling carried out at a qualified specialist workshop.

## Front airbags



Driver's airbag ① deploys in front of the steering wheel. Front-passenger front airbag ② deploys in front of and above the glove compartment.

When deployed, the front airbags offer additional head and thorax protection for the occupants in the front seats.

The PASSENGER AIR BAG OFF and PASSENGER AIR BAG ON indicator lamps inform you about the status of the front-passenger front airbag (▷ page 39).

## Driver's kneebag



Driver's kneebag ① deploys under the steering column. The driver's kneebag is triggered together with the front airbags. The driver's kneebag offers additional thigh, knee and lower leg protection for the occupant in the driver's seat.

## Head/thorax airbags

### WARNING

Unsuitable seat covers can obstruct or prevent the deployment of the airbags integrated into the seats. Consequently, the airbags cannot protect vehicle occupants as they are designed to do. This poses an increased risk of injury or even fatal injury.

You should only use seat covers that have been approved for the corresponding seats by smart.

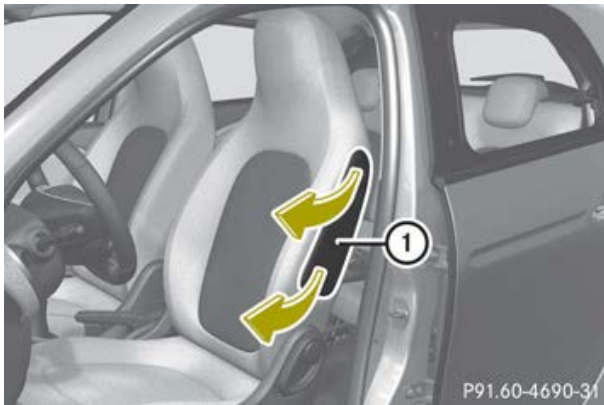

Head/thorax airbags ① deploy next to the outer bolster of the seat backrest.

When deployed, the head/thorax airbag offers additional head and thorax protection. However, it does not protect the arms.

### Deployment of belt tensioners and airbags

#### Important safety notes

### WARNING

After the airbag deploys, the airbag parts are hot. There is a risk of injury.

Do not touch the airbag parts. Have a deployed airbag replaced at a qualified specialist workshop as soon as possible.

### WARNING

Pyrotechnic seat belt tensioners that have been deployed are no longer operational and are unable to perform their intended

protective function. This poses an increased risk of injury or even fatal injury.

Therefore, have pyrotechnic belt tensioners which have been triggered immediately replaced at a qualified specialist workshop.

smart recommends that you have the vehicle towed to a qualified specialist workshop after an accident. Take this into account, particularly if a seat belt tensioner was triggered or an airbag was deployed.

If the belt tensioners are triggered or an airbag is deployed, you will hear a bang, and a small amount of powder may also be released. The  restraint system warning lamp lights up.

Only in rare cases will the bang affect your hearing. In general, the powder released is not hazardous to health but may cause short-term breathing difficulties to persons suffering from asthma or other pulmonary conditions. Provided it is safe to do so, you should leave the vehicle immediately or open the window in order to prevent breathing difficulties.

### Method of operation

During the first stage of a collision, the restraint system control unit evaluates important physical data relating to vehicle deceleration or acceleration, such as:

- duration
- direction
- intensity

Based on the evaluation of this data, the restraint system control unit triggers the seat belt tensioners in the event of a head-on or rear collision.

A seat belt tensioner can only be triggered if:

- the ignition is switched on
- the components of the restraint system are operational; see "Restraint system warning lamp" (▷ page 38)
- the belt tongue has engaged in the belt buckle of the respective front seat

If the restraint system control unit detects a high severity of an accident, in certain head-on collisions, additional components of the restraint system are deployed independently of each other:

- front airbags and driver's kneebag

The front-passenger front airbag can only be deployed in an accident if the PASSENGER AIR BAG OFF indicator lamp is off. Observe the information on the PASSENGER AIR BAG OFF indicator lamp (▷ page 39).

The activation threshold for the seat belt tensioners and airbags is determined based on the evaluation of the vehicle's rate of deceleration or acceleration at various points in the vehicle. This process is pre-emptive in nature. The triggering/deployment process should take place in good time at the start of the collision.

The rate of vehicle deceleration or acceleration and the direction of the force are essentially determined by:

- the distribution of forces during the collision
- the collision angle
- the deformation characteristics of the vehicle
- the characteristics of the object with which the vehicle has collided

Factors which can only be seen and measured after a collision has occurred do not play a decisive role in the deployment of an airbag, nor do they provide an indication of airbag deployment.

The vehicle may be deformed significantly without an airbag being deployed. This is

the case if only parts which are relatively easily deformed are affected and the rate of deceleration is not high. Conversely, an airbag may be deployed even though the vehicle suffers only minor deformation. This is the case if, for example, very rigid vehicle parts such as longitudinal body members are hit, and sufficient deceleration occurs as a result.

If the restraint system control unit detects a side impact, the applicable components of the restraint system are activated independently of each other depending on the apparent type of accident.

The head/thorax airbag will deploy on the side on which an impact occurs, independent from the seat belt tensioner and seat belt usage

- i** Not all airbags are deployed in an accident. The different airbag systems work independently of each other.

How the airbag system works is determined by the severity of the accident detected, especially the vehicle deceleration or acceleration, and the apparent type of accident:

- head-on collision
- side impact

## Children in the vehicle

### Important safety notes

Accident statistics show that children secured on the rear seats are safer than children secured on the front seats. For this reason, smart strongly advises that you install a child restraint system on a rear seat.

If a child younger than 12 years old and under 1.50 m in height is travelling in the vehicle:

- always secure the child in a child restraint system suitable for smart vehicles. The child restraint system

must be appropriate to the age, weight and size of the child

- be sure to observe the instructions and safety notes in this section in addition to the child restraint system manufacturer's installation instructions

#### **WARNING**

If you leave children unattended in the vehicle, they may be able to set the vehicle in motion if, for example, they:

- release the parking brake
- shift the automatic transmission out of park position **P** or shift manual transmission into neutral
- start the engine

In addition, they may operate vehicle equipment and become trapped. There is a risk of an accident and injury.

When leaving the vehicle, always take the key with you and lock the vehicle. Never leave children unattended in the vehicle.

#### **WARNING**

If persons (particularly children) are exposed to heat or cold for a prolonged period, there is a risk of serious or even fatal injuries. Never leave persons (particularly children) unattended in the vehicle.

#### **WARNING**

If the child restraint system is placed in direct sunlight, the parts could become very hot. Children could be suffer burns by touching these parts, in particular on the metallic parts of the child restraint system. There is a risk of injury.

If you and your child leave the vehicle, always make sure that the child restraint system is not in direct sunlight. Cover it with a blanket, for example. If the child restraint system has been exposed to direct sunlight, leave it to cool down before securing the child in it. Never leave children unattended in the vehicle.

Always ensure that all vehicle occupants have their seat belts fastened correctly and are sitting properly. Particular attention must be paid to children.

Observe the safety notes on the seat belt (▷ page 40) and the notes on correct use of seat belts (▷ page 41).

### Child restraint system

Observe the instructions for correct use of the child restraint system (▷ page 54).

For safety reasons, smart recommends that you only use a child restraint system recommended by smart (▷ page 58).

#### **WARNING**

If the child restraint system is incorrectly fitted on the seat position suitable for this purpose, it cannot perform its intended protective function. In the event of an accident, sharp braking or a sudden change in direction, the child may not be held securely. There is an increased risk of serious or even fatal injuries.

Observe the manufacturer's installation instructions and the correct use for the child restraint system. Make sure that the entire surface of the child restraint system is resting on the seat surface. Never place objects under or behind the child restraint system, e.g. cushions. Only use child restraint systems with the original cover designed for them. Only replace damaged covers with genuine covers.

#### **WARNING**

If the child restraint system is fitted incorrectly or is not secured, it can come loose in the event of an accident, heavy braking or a sudden change in direction. The child restraint system could be thrown about, striking vehicle occupants. There is an increased risk of injury, possibly even fatal.

Always fit child restraint systems properly, even if they are not being used. Make sure that you observe the child restraint system manufacturer's installation instructions.

You will find further information on stowing objects, luggage or loads under "Loading guidelines" (▷ page 204).

### WARNING

Child restraint systems or their securing systems that have been damaged or subjected to a load in an accident cannot perform their intended protective function. In the event of an accident, sharp braking or a sudden change in direction, the child may not be held securely. There is an increased risk of serious or even fatal injuries.

Immediately replace child restraint systems that have been damaged or subjected to a load in an accident. Have the child restraint securing systems checked in a qualified specialist workshop before fitting a child restraint system again.

Securing systems for child restraint systems include:

- the seat belt system
- the ISOFIX securing rings
- the Top Tether anchorages

**i** If it is absolutely necessary to carry a child on the front-passenger seat, be sure to observe the information on "Child restraint systems on the front-passenger seat" (▷ page 52). There you will also find information on disabling the front-passenger front airbag.

Observe the warning labels in the vehicle interior and on the child restraint system.

## ISOFIX child seat securing system

### WARNING

ISOFIX child restraint systems do not offer sufficient protective effect for children whose weight is greater than 22 kg who are secured using the safety belt integrated in the child restraint system. The child could, for example, not be restrained correctly in the event of an accident. This poses an increased risk of injury or even fatal injury.

If the child weighs more than 22 kg, only use ISOFIX child restraint systems with which the child is also secured with the vehicle seat belt. Also secure the child restraint system with the Top Tether belt, if available.

When fitting a child restraint system, be sure to observe the manufacturer's installation instructions and the instructions for correct use of the child restraint system (▷ page 54).

Before every trip, make sure that the ISOFIX child restraint system is engaged correctly in both ISOFIX securing rings.



① ISOFIX securing rings

► Install the ISOFIX child restraint system on both ISOFIX securing rings ①.

ISOFIX is a standardised securing system for specially designed child restraint systems on the rear seats. ISOFIX securing rings ① for two ISOFIX child restraint systems are fitted on the left and right of the rear seats.

Secure child restraint systems without an ISOFIX child seat securing system using the seat belts in the vehicle. When fitting a child restraint system, be sure to observe the manufacturer's installation and operating instructions and the instructions for correct use of the child restraint system (▷ page 54).

## Top Tether

### Introduction

Top Tether provides an additional connection between the child restraint system secured with ISOFIX and the vehicle. It helps reduce the risk of injury even further. If the child restraint system is fitted with a Top Tether belt, this should always be used.

### Important safety notes

#### WARNING

If the rear seat backrests are not locked, they could fold forwards in the event of an accident, heavy braking or sudden changes of direction. As a result, child restraint systems cannot perform their intended protective function. Rear seat backrests that are not locked can also cause additional injuries, e.g. in the event of an accident. This poses an increased risk of injury or even fatal injury.

Always lock rear seat backrests after fitting a Top Tether belt. Observe the lock verification indicator. Adjust the rear seat backrests so that they are in an upright position.

### Top Tether anchorages



① Top Tether anchorage

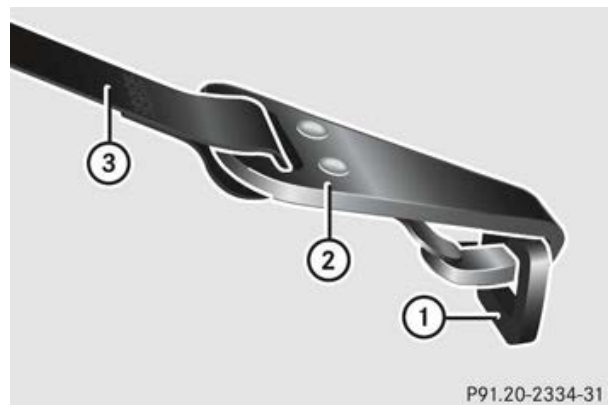

① Top Tether anchorage

② Top Tether hook

③ Top Tether belt

Top tether anchorage ① is fitted behind each rear seat to the luggage compartment floor.

- ▶ Fit the ISOFIX child restraint system with Top Tether. Always comply with the child restraint system manufacturer's installation instructions when doing so.
- ▶ Move the head restraint upwards.
- ▶ Route Top Tether belt ③ under the head restraint between the two head restraint bars.
- ▶ Guide Top Tether belt ③ between the rear seat backrest and parcel shelf into the luggage compartment.

Remove the parcel shelf (▷ page 208) if necessary.

- ▶ Hook Top Tether hook ② of Top Tether belt ③ into Top Tether anchorage ①.

Lift up the carpet a little if necessary.  
Ensure that:

- Top Tether hook ② is hooked into Top Tether anchorage ① as shown.
  - Top Tether belt ③ is not twisted.
  - Top Tether belt ③ is routed between the rear seat backrest and the parcel shelf if the parcel shelf is fitted.
- Tension Top Tether belt ③. Always comply with the child restraint system manufacturer's installation instructions when doing so.
- Move the head restraint back down again slightly if necessary.  
Make sure that you do not interfere with the correct routing of Top Tether belt ③.

#### Disabling/activating the front-passenger front airbag

##### WARNING

If the PASSENGER AIRBAG OFF indicator lamp is lit, the front-passenger front airbag is disabled. It will not be deployed in the event of an accident and cannot perform its intended protective function. A person in the front-passenger seat could then, for example, come into contact with the vehicle's interior, especially if the person is sitting too close to the dashboard. This poses an increased risk of injury or even fatal injury.

In this case the front-passenger seat may not be used. You may only transport a child on the front-passenger seat if they are seated in a suitable rearward or forward-facing child restraint system. Always observe the information about suitable positioning of the child restraint system in this Owner's Manual as well as the child restraint system manufacturer's installation instructions.

##### WARNING

If you secure a child on the co-driver's seat in a rearward-facing child restraint system and the PASSENGER AIR BAG ON indicator lamp lights up, the co-driver's airbag could be deployed in the event of an accident. The child could be struck by the airbag. There is an increased risk of injury, possibly even fatal.

In this case, always ensure that the co-driver's airbag is disabled. The PASSENGER AIRBAG OFF indicator lamp must light up.

If the PASSENGER AIR BAG OFF indicator lamp remains off and/or the PASSENGER AIR BAG ON indicator lamp is lit, do not fit a rearward-facing child restraint system to the front-passenger seat. For more information, see "Problems with automatic front-passenger airbag deactivation" (▷ page 54).

##### WARNING

If you secure a child in a forward-facing child restraint system on the front-passenger seat and you position the front-passenger seat too close to the dashboard, in the event of an accident, the child could:

- come into contact with the vehicle's interior if the PASSENGER AIR BAG OFF indicator lamp is lit, for example
- be struck by the airbag if the PASSENGER AIR BAG ON is lit up

This poses an increased risk of injury or even fatal injury.

Move the front-passenger seat as far back as possible. Always make sure that the shoulder belt strap is correctly routed from the vehicle belt outlet to the shoulder belt guide on the child restraint system. The shoulder belt strap must be routed forwards and downwards from the vehicle belt outlet. If necessary, adjust the vehicle belt outlet and the front-passenger seat accordingly. Always observe the information in this Owner's Manual on suitable

positioning of the child restraint system in addition to the child restraint system manufacturer's installation instructions.



Warning symbol for a rearward-facing child restraint system

If you use a rearward-facing child restraint system on the front-passenger seat, you must disable the front-passenger front airbag.



The airbag-off switch for manually activating and disabling the front-passenger front airbag is in the dashboard on the front-passenger side.

- ▶ Push in airbag-off switch ① beyond the point of resistance.
- ▶ **To disable the front-passenger front airbag:** turn airbag-off switch ① anti-clockwise.

The PASSENGER AIR BAG OFF  indicator lamp on the overhead control panel

lights up and stays on when the ignition is switched on (▷ page 39).

- ▶ **To activate the front-passenger front airbag:** turn airbag-off switch ① clockwise.

The PASSENGER AIR BAG ON  indicator lamp on the overhead control panel lights up and stays on when the ignition is switched on (▷ page 39).

The passenger airbag is enabled when the ignition is switched on unless the passenger airbag has been manually disabled. If the passenger airbag is deactivated and the ignition is switched on, the PASSENGER AIR BAG OFF  indicator lamp in the overhead control panel (▷ page 39) lights up permanently.

### Child restraint system on the front-passenger seat

#### General notes

Accident statistics show that children secured in the rear seats are safer than children secured in the front-passenger seat. For this reason, smart strongly advises that you install a child restraint system on a rear seat.

If you secure a child in a child restraint system on the front-passenger seat, always observe the information on "Disabling the front-passenger front airbag" (▷ page 51). You can thus avoid the risks that could arise as a result of:

- the enabling or disabling of the front-passenger front airbag by mistake
- the unsuitable positioning of the child restraint system, e.g. too close to the dashboard



Please observe the warning notice on the front-passenger sun visor, see the illustration.

#### **WARNING**

If you secure a child in a child restraint system on the front-passenger seat and the PASSENGER AIR BAG OFF indicator lamp is off, the front-passenger front airbag can deploy in the event of an accident. The child could be struck by the airbag. This poses an increased risk of injury or even fatal injury.

Make sure that the front-passenger front airbag has been disabled. The PASSENGER AIRBAG OFF indicator lamp must be lit.

NEVER use a rearward facing child restraint on a seat protected by an ACTIVE AIRBAG in front of it, DEATH or SERIOUS INJURY to the CHILD can occur.

#### **Rearward-facing child restraint system**



Warning symbol for a rearward-facing child restraint system



If it is absolutely necessary that you secure a child in a rearward-facing child restraint system on the front-passenger seat, always make sure that the front-passenger front airbag is disabled. Only if the PASSENGER AIR BAG OFF indicator lamp is permanently lit (▷ page 39) is the front-passenger front airbag disabled.

Always observe the information on suitable positioning of the child restraint system (▷ page 54) in addition to the child restraint system manufacturer's installation and operating instructions.

#### **Forward-facing child restraint system**

If it is absolutely necessary to fit a forward-facing child restraint system to the front-passenger seat, always move the front-passenger seat as far back as possible. Always make sure that the shoulder belt strap is correctly routed from the front-passenger seat belt guide to the shoulder belt guide on the child restraint system. The shoulder belt strap must be routed forwards and downwards from the front-passenger seat belt guide. If necessary, adjust the front-passenger seat accordingly.

**Problems with automatic front-passenger airbag deactivation**

Problem	Possible causes/consequences and ► Solutions
The PASSENGER AIR BAG OFF  indicator lamp on the overhead control panel is lit.	The front-passenger airbag has been disabled manually (▷ page 51). ► Nobody may use the front-passenger seat unless a suitable rearward-facing child restraint system is being used.
	The front-passenger airbag has not been disabled manually (▷ page 51). The airbag deactivation is malfunctioning. ► Do not use a rearward-facing child restraint system on the front-passenger seat. ► Visit a qualified specialist workshop.
The PASSENGER AIR BAG OFF  indicator lamp on the overhead control panel is lit.	The passenger airbag has been manually activated (▷ page 51). The system operates correctly. ► Do not use a rearward-facing child restraint system on the front-passenger seat.
The PASSENGER AIR BAG ON  indicator lamp does not light up if the passenger airbag on the overhead control panel was activated manually.	The airbag system is malfunctioning. ► Nobody may use the front-passenger seat. ► Visit a qualified specialist workshop.

**Suitable positioning of the child restraint system**
**Introduction**

Only child restraint systems which are approved in accordance with the ECE standard ECE R44 are permitted for use in the vehicle.

For certain child restraint systems in weight categories II or III, this can mean that the area of use is restricted. The maximum size setting of the child restraint system is not possible due to possible contact with the roof.

"Universal" category child restraint systems can be recognised by their orange approval label and the text "Universal".

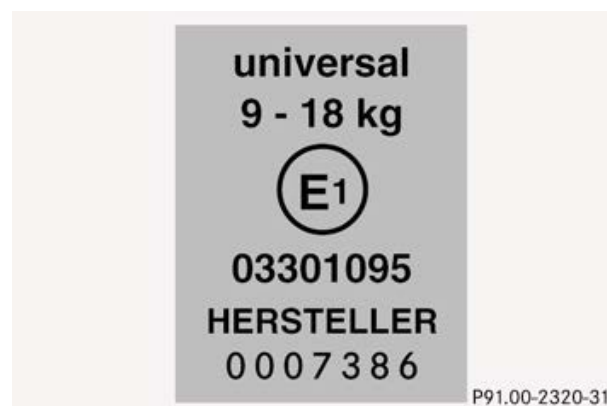

Example: approval label on the child restraint system

"Universal" category child restraint systems can be used on the seats indicated with U, UF or IUF according to the tables "Suitability of the seats for attaching belt-secured child restraint systems" or

"Suitability of the seats for attaching an ISOFIX child restraint system".

Semi-universal child restraint systems are indicated by the text "Semi-universal" on the approval label. These can be used if the vehicle and the seat are listed in the child restraint system manufacturer's vehicle model list. For more information, contact the child restraint system manufacturer or visit their website.

Before installing a forward-facing child restraint system with integrated backrest on the rear seat, remove the corresponding head restraint.

**Child restraint system on the front-passenger seat** – if it is absolutely necessary to fit a child restraint system to the front-passenger seat:

- ▶ Always pay attention to the instructions under "Child restraint system on the front-passenger seat" (▷ page 52).

There you will find instructions on how to correctly route the shoulder belt strap from the vehicle belt outlet to the shoulder belt guide on the child restraint system (▷ page 53).

- ▶ Move the front-passenger seat as far back as possible.
- ▶ Move the backrest to an almost vertical position.

The base of the child restraint system must lie fully against the seat cushion of the front-passenger seat. The back of a forward-facing child restraint system must lie as flat as possible against the front-passenger backrest. The child restraint system must not touch the roof or be subjected to a load by the head restraint. Adjust the backrest angle accordingly. Also observe the child restraint system manufacturer's installation instructions.

### Suitability of the seats for attaching belt-secured child restraint systems

If you are using a baby car seat of weight category 0 or 0+, or a Group I rearward-facing child restraint system on a rear seat, the driver's or front-passenger seat must be adjusted in such a way that it does not come into contact with the child restraint system.

In addition, always observe the information given under "Child restraint system" (▷ page 48), as well as the child restraint system manufacturer's installation instructions.

Legend for the table:

- X Seat which is unsuitable for children in this weight category.
- U Suitable for child restraint systems in the "Universal" category that are approved for use in this weight category.
- UF Suitable for forward-facing child restraint systems that belong to the "Universal" category and are approved for use in this weight category.
- L Suitable for child restraint systems as recommended, see the table of "Recommended child restraint systems" (▷ page 58). Suitable for semi-universal child-restraint systems if the vehicle and the seat are listed in the child restraint system manufacturer's vehicle model list.

#### Front-passenger seat

Weight categories	Front-passenger front air-bag is activated	Front-passenger front air-bag is deactivated <sup>1</sup>
Category 0: up to 10 kg	X	U, L
Category 0+: up to 13 kg	X	U, L
Category I: 9 to 18 kg	UF, L	U, L
Category II: 15 to 25 kg	UF, L	U, L
Category III: 22 to 36 kg	U, L	U, L

#### Rear seats

Weight categories	Left, right
Category 0: up to 10 kg	U, L
Category 0+: up to 13 kg	U, L
Category I: 9 to 18 kg	U, L
Category II: 15 to 25 kg	U, L
Category III: 22 to 36 kg	U, L

<sup>1</sup> The front-passenger front airbag must be deactivated. The PASSENGER AIR BAG OFF indicator lamp must be on.

## Suitability of the seats for attaching ISOFIX child restraint systems

If you are using a baby car seat of weight category 0 or 0+, or a Group I rearward-facing child restraint system on a rear seat, the driver's or front-passenger seat must be adjusted in such a way that it does not come into contact with the child restraint system.

In addition, always observe the information given under "Child restraint system" (▷ page 48), as well as the child restraint system manufacturer's installation instructions.

Legend for the table:

- X ISOFIX position that is not suitable for ISOFIX child restraint systems in this weight category and/or size category.
- IUF Suitable for forward-facing ISOFIX child seat securing systems that belong to the "universal" category which are approved for use in this weight category.
- IL Suitable for ISOFIX child restraint systems as recommended; see the following table of "Recommended child restraint systems" (▷ page 58).

The manufacturer will also recommend a suitable ISOFIX child restraint system. For this, your vehicle and the seat must be listed in the child restraint system manufacturer's model list. For more information, contact the child restraint system manufacturer or visit their website.

Weight category		Size category	Equipment	Left/right rear seat
<b>Carry-cot</b>		F	ISO/L1	X
		G	ISO/L2	X
<b>0</b>	up to 10 kg up to approximately 6 months	E	ISO/R1	IL
<b>0+</b>	up to 13 kg up to approximately 15 months	E	ISO/R1	IL
		D	ISO/R2	IL
		C	ISO/R3	X
<b>I</b>	9 kg up to 18 kg between approximately 9 months and 4 years	D	ISO/R2	IL
		C	ISO/R3	X
		B	ISO/F2	IUF
		B1	ISO/F2X	IUF
		A	ISO/F3	IUF

## Recommended child restraint systems

### General notes

Always observe the information in "Child restraint systems on the front-passenger seat" (▷ page 52) and in "Suitable positioning of the child restraint system" (▷ page 54).

You can obtain further information about the correct child restraint system from any smart centre.

The smart forfour does not have automatic child seat recognition.

- ▶ Before using a rearward-facing child restraint on the front-passenger seat, disable the front-passenger airbag (▷ page 51).

>> Safety.

### Recommended child restraint systems for attaching with the vehicle seat belt

Weight category	Manufacturer	Type	Approval number (E1 ...)	Order number (A 000 ...)²
<b>Category 0:</b> up to 10 kg up to approximately 6 months	Britax Römer	BABY SAFE PLUS	03 301146 04 301146	970 10 00
		BABY SAFE plus II	04 301146	970 20 00
<b>Category 0+:</b> up to 13 kg up to approximately 15 months	Britax Römer	BABY SAFE PLUS	03 301146 04 301146	970 10 00
		BABY SAFE plus II	04 301146	970 20 00
<b>Category I:</b> 9 kg up to 18 kg between approximately 9 months and 4 years	Britax Römer	DUO PLUS	03 301133 04 301133	970 16 00
<b>Category II/III:</b> 15 kg up to 36 kg from approximately 4 years to 12 years	Britax Römer	KIDFIX³	04 301198	970 19 00

<sup>2</sup> Colour code 9H95

<sup>3</sup> Before fitting the KIDFIX child restraint system in the vehicle, always observe the child restraint system manufacturer's installation instructions. These also contain information on the different installation methods possible.

## Recommended ISOFIX child restraint systems for the "Universal"/"Semi-Universal" category

Weight category	Size category	Manufacturer	Type	Approval number (E1 ...)	Order number <sup>2</sup>
<b>Category 0+:</b> up to 13 kg	E	Britax Römer	BABY SAFE plus	03 301146 04 301146	B6 6 86 8224
<b>Category I:</b> 9 kg up to 18 kg	B1	Britax Römer	DUO PLUS	03 301133 04 301133	A 000 970 16 00

>> Safety.

### Child-proof locks

#### Important safety notes

##### WARNING

If children are travelling in the vehicle, they could:

- open doors, thus endangering other people or road users
- exit the vehicle and be caught by oncoming traffic
- operate vehicle equipment and become trapped, for example

There is a risk of an accident and injury. Always activate the child-proof locks and override feature if children are travelling in the vehicle. When leaving the vehicle, always take the key with you and lock the vehicle. Never leave children unattended in the vehicle.

Child-proof locks for the rear doors (▷ page 60).

##### WARNING

If you leave children unattended in the vehicle, they may be able to set the vehicle in motion if, for example, they:

- release the parking brake
- shift the manual transmission into neutral
- start the engine

In addition, they may operate vehicle equipment and become trapped. There is a risk of an accident and injury.

When leaving the vehicle, always take the key with you and lock the vehicle. Never leave children unattended in the vehicle.

##### WARNING

If persons (particularly children) are exposed to heat or cold for a prolonged period, there is a risk of serious or even fatal injuries. Never leave persons (particularly children) unattended in the vehicle.

##### WARNING

If the child restraint system is placed in direct sunlight, the parts could become very hot. Children could be suffer burns by touching these parts, in particular on the metallic parts of the child restraint system. There is a risk of injury.

<sup>2</sup> Colour code 9H95

If you and your child leave the vehicle, always make sure that the child restraint system is not in direct sunlight. Cover it with a blanket, for example. If the child restraint system has been exposed to direct sunlight, leave it to cool down before securing the child in it. Never leave children unattended in the vehicle.

### Child-proof locks for the rear doors

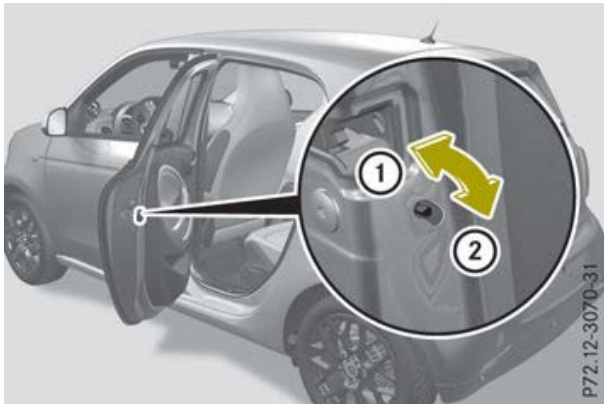

You secure each door individually with the child-proof locks on the rear doors. A door secured with a child-proof lock cannot be opened from inside the vehicle. When the vehicle is unlocked, the door can be opened from the outside.

- ▶ **To activate:** press the child-proof lock lever down in the direction of arrow ②.
- ▶ Make sure that the child-proof locks are working properly.
- ▶ **To deactivate:** press the child-proof lock lever up in the direction of arrow ①.

### Pets in the vehicle

#### WARNING

If you leave animals unsupervised or unsecured in the vehicle, they may push a button or a switch, for example.

They could:

- activate vehicle equipment and become trapped, for example
- switch vehicle systems on or off, thus endangering other road users

In the event of an accident, sudden braking or abrupt changes of direction, unsecured animals could be flung around the vehicle, injuring the vehicle occupants. There is a risk of an accident and injury.

Never leave animals unattended in the vehicle. Always secure animals correctly during a journey, e.g. in an animal transport box.

### Protection against theft

#### Immobiliser

The immobiliser prevents your vehicle from being started without the correct key.

- ▶ **To activate:** remove the key from the ignition lock.
- ▶ **To deactivate:** switch on the ignition.

When leaving the vehicle, always take the key with you and lock the vehicle. The engine can be started by anyone with a valid key that is left inside the vehicle.

-  The immobiliser is always deactivated when you start the engine.

#### Anti-theft alarm system

##### Activating

- ▶ Make sure that:
  - the side windows are closed.
  - no objects, such as mascots, are hanging from the rear-view mirror or grab handles.
 This will prevent false alarms.
- ▶ Make sure that:

- the doors are closed.
  - the tailgate is closed
  - the service cover is closed.
- ▶ Press the  button on the key.  
The alarm system is primed after approximately 30 seconds.
- i** If the service cover is open or is not properly closed, the vehicle will be locked. The anti-theft alarm system is primed. To remind you that the service cover is not secured, a warning tone sounds for 30 seconds. Ensure that the service cover is properly closed. Only then is the anti-theft alarm system correctly primed and the service cover properly secured.

### Deactivating

- ▶ Press the  button on the key.
- or
- ▶ Unlock the vehicle by using the key in the emergency lock.  
and  
Switch the ignition on.

### Examples for triggering the alarm

A visual and audible alarm is triggered if the alarm system is primed and you open:

- the vehicle by using the key in the emergency lock
- a door
- the tailgate
- the service cover

### Switching off the alarm

- ▶ **To switch off the alarm:** press the  button on the key.  
The alarm is switched off.
- or
- ▶ Insert the key into the ignition lock.  
The alarm is switched off.

The alarm is not switched off, even if you close the open door that has triggered it, for example.

## Driving safety systems

### Driving safety systems overview

In this section, you will find information about the following driving safety systems:

- ABS (**A**nti-**l**ock **B**raking **S**ystem)  
(▷ page 62)
- Distance warning function (▷ page 62)
- Adaptive brake lamps (▷ page 64)
- esp® (**E**lectronic **S**tability **P**rogram)  
(▷ page 64)
- EBD (**e**lectronic **b**rake force **d**istribution) (▷ page 65)

### Important safety notes

If you fail to adapt your driving style or if you are inattentive, the driving safety systems can neither reduce the risk of accident nor override the laws of physics. Driving safety systems are merely aids designed to assist driving. You are responsible for the distance to the vehicle in front, for vehicle speed and for braking in good time. Always adapt your driving style to suit the prevailing road, weather and traffic conditions and maintain a safe distance from the vehicle in front. Drive carefully.

The driving safety systems described only work as effectively as possible when there is adequate contact between the tyres and the road surface. Please pay special attention to the notes on tyres, recommended minimum tyre tread depths, etc. (▷ page 248).

In wintry driving conditions, always use winter tyres (M+S tyres) and, if necessary, snow chains. Only in this way will the driving safety systems described in this section work as effectively as possible.

For safety reasons, smart recommends that you only use snow chains that have been specially approved for your vehicle by smart, or fine-link snow chains that are of a corresponding standard of quality. For more information, please contact a qualified specialist workshop.

## ABS (Anti-lock Braking System)

### General notes

abs regulates brake pressure in such a way that the wheels do not lock when you brake. This allows you to continue steering the vehicle when braking.

The  abs warning lamp in the instrument cluster lights up when the ignition is switched on. It goes out when the engine is running.

### Important safety notes

-  Observe the "Important safety notes" section for driving safety systems (▷ page 61).

When abs is malfunctioning, other systems, including driving safety systems, will also become inoperative. Observe the information on the abs warning lamp (▷ page 191) and display messages which may be shown in the instrument cluster (▷ page 176).

#### WARNING

If ABS is faulty, the wheels could lock when braking. The steerability and braking characteristics may be severely impaired. Additionally, further driving safety systems are deactivated. There is an increased danger of skidding and accidents.

Drive on carefully. Have ABS checked immediately at a qualified specialist workshop.

abs works from a speed of about 6 km/h, regardless of road-surface conditions. abs works on slippery surfaces, even when you only brake gently.

## Braking

- ▶ **If abs intervenes:** continue to depress the brake pedal with force until the braking situation is over.
- ▶ **To make a full brake application:** depress the brake pedal with full force.

If abs intervenes when braking, you will feel a pulsing in the brake pedal.

The pulsating brake pedal can be an indication of hazardous road conditions, and functions as a reminder to take extra care while driving.

## Distance warning function

### General notes

The distance warning function can help you to minimise the risk of a collision with a vehicle ahead or reduce the effects of such an accident. If the distance warning function detects that there is a risk of a collision, you will be warned visually and acoustically.

Starting the engine also switches on the distance warning function.

### Important safety notes

#### WARNING

The distance warning function does not react:

- to people or animals
- to oncoming vehicles
- to crossing traffic
- when cornering

Thus, the distance warning function cannot provide a warning in all critical situations. There is a risk of an accident.

Always pay careful attention to the traffic situation and be ready to brake.

### ⚠ WARNING

The distance warning function cannot always clearly identify objects and complex traffic situations.

In such cases, the distance warning function may:

- give an unnecessary warning
- not give a warning

There is a risk of an accident.

Always pay careful attention to the traffic situation; do not rely on the distance warning function alone.

Observe the "Important safety notes" section for driving safety systems (▷ page 61).

In particular, the detection of obstacles can be impaired if there is:

- dirt on the sensors or anything else covering the sensors
- snow or heavy rain
- interference by other radar sources
- the possibility of strong radar reflections, for example, in multi-storey car parks
- a narrow vehicle travelling in front, e.g. a motorcycle
- a vehicle travelling in front on a different line
- new vehicles or after a service on the distance warning system

Please observe the information in the section on running-in the vehicle (▷ page 120).

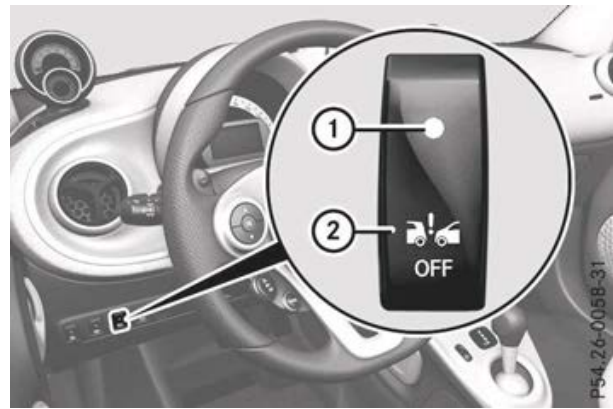

Following damage to the front end of the vehicle, have the configuration and operation of the radar sensor checked at a qualified specialist workshop. This also applies to collisions at slow speeds where there is no visible damage to the front of the vehicle.

### Function



- ▶ **To switch off:** press button ②. Indicator lamp ① lights up.
- ▶ **To switch on:** press button ②. Indicator lamp ① goes out.

The distance warning function issues a warning at speeds:

- of around 30 km/h or more, if, over several seconds, the distance maintained to the vehicle travelling in front is insufficient. The  distance warning lamp then lights up in the instrument cluster.
  - of around 7 km/h or more, if you rapidly approach a vehicle in front. An intermittent warning tone will then sound and the  distance warning lamp will light up in the instrument cluster.
- ▶ Brake immediately in order to increase the distance from the vehicle in front.

or

- ▶ Take evasive action provided it is safe to do so.

Due to the nature of the system, particularly complicated but non-critical driving conditions may also cause the system to display a warning.

With the help of the radar sensor system, the distance warning function can detect obstacles that are in the path of your vehicle for an extended period of time.

Up to a speed of around 70 km/h, the distance warning function can also react to stationary obstacles, such as stopped or parked vehicles.

### Adaptive brake lamps

The adaptive brake lights warn following traffic in an emergency braking situation:

- by flashing brake lamps
- the hazard warning lamps are activated

If you brake sharply from a speed of more than 50 km/h the brake lamps flash rapidly. In this way, traffic travelling behind you is warned in an even more noticeable manner.

If you brake sharply from a speed of more than 70 km/h to a standstill, the hazard warning lamps are activated automatically. If the brakes are applied again, the brake lamps light up continuously. The hazard warning lamps switch off automatically if you travel faster than 10 km/h. You can also switch off the hazard warning lamps using the hazard warning button (▷ page 96).

### ESP® (Electronic Stability Program)

#### General notes

- i** Observe the "Important safety notes" section (▷ page 61).

esp® monitors driving stability and traction, i.e. power transmission between the tyres and the road surface.

If esp® detects that the vehicle is deviating from the direction desired by the driver, one or more wheels are braked to stabilise the vehicle. The engine output is also modified to keep the vehicle on the desired course within physical limits. esp® assists the driver when pulling away on wet or slippery roads. esp® can also stabilise the vehicle during braking.

#### ETS (Electronic Traction System)

- i** Observe the "Important safety notes" section (▷ page 61).

ETS traction control is part of esp®.

ETS brakes the drive wheels individually if they spin. This enables you to pull away and accelerate on slippery surfaces, for example if the road surface is slippery on one side. In addition, more drive torque is transferred to the wheel with traction.

#### Important safety notes

##### WARNING

If ESP® is malfunctioning, ESP® is unable to stabilise the vehicle. In addition, other driving safety systems are switched off. This increases the risk of skidding and an accident.

Drive on carefully. Have ESP® checked at a qualified specialist workshop.

- !** If you test the parking brake using a brake dynamometer, switch the ignition off. Application of the brakes by ESP® may otherwise destroy the brake system.

Observe the notes on esp® when towing away your vehicle with the rear axle raised (▷ page 240).

If the  esp® warning lamp lights up permanently, esp® or hill start assist are unavailable due to a malfunction.

Observe the information on warning lamps (▷ page 193) and display messages which may be shown in the instrument cluster (▷ page 177).

- i** Only use wheels with the recommended tyre sizes. Only then will esp® function properly.

#### Characteristics of ESP®

##### General notes

If the  esp® warning lamp goes out before the journey begins, esp® is automatically active.

If esp® intervenes, the  esp® warning lamp flashes in the instrument cluster.

If esp® intervenes:

- ▶ When pulling away, only depress the accelerator pedal as far as is necessary.
- ▶ Adapt your driving style to suit the prevailing road and weather conditions.

### **crosswind assist**

#### **General notes**

Strong crosswind gusts can impair the roadholding of your vehicle when driving straight ahead. The crosswind driving assistance function integrated in esp® noticeably reduces these impairments.

Depending on the direction and intensity of the side wind, esp® is activated automatically.

esp® intervenes with stabilising braking to assist you in keeping the vehicle in the lane.

crosswind assist is active at vehicle speeds above 70 km/h when driving straight ahead or cornering gently.

#### **Important safety notes**

crosswind assist does not work if esp® is disabled because of a malfunction.

### **EBD (electronic brake force distribution)**

#### **General notes**

EBD monitors and controls the brake pressure on the rear wheels to improve driving stability while braking.

#### **Important safety notes**

- i** Observe the "Important safety notes" section (▷ page 61).

#### **⚠ WARNING**

If EBD is malfunctioning, the rear wheels can lock, e.g. under full braking. This

increases the risk of skidding and an accident.

You should therefore adapt your driving style to the different handling characteristics. Have the brake system checked at a qualified specialist workshop.

Observe information regarding indicator and warning lamps (▷ page 193) as well as display messages (▷ page 175).



Useful information .....	68
Key .....	68
Doors .....	72
Luggage compartment .....	75
Side windows .....	76
Folding top .....	79
Operating the roller sunblinds for the panoramic roof .....	81

### Useful information

- i** This Owner's Manual describes all models, series and optional equipment for your vehicle that were available at the time of going to press. Country-specific differences are possible. Note that your vehicle may not be fitted with all features described. This is also the case for systems and functions relevant to safety.
- i** Read the information on qualified specialist workshops: (▷ page 21).

### Key

#### Important safety notes

##### **WARNING**

If children are left unsupervised in the vehicle, they could:

- open doors, thereby endangering other persons or road users
- get out and be struck by oncoming traffic
- operate vehicle equipment and become trapped, for example

In addition, the children could also set the vehicle in motion, for example, if they:

- release the parking brake
- shift the automatic transmission out of park position P or shift manual transmission into neutral
- start the engine

There is a risk of an accident and injury.

When leaving the vehicle, always take the key with you and lock the vehicle. Never leave children and animals unattended in the vehicle. Keep the keys out of the reach of children.

##### **WARNING**

If you attach heavy or large objects to the key, the key could be unintentionally turned in the ignition lock. This could

cause the engine to be switched off. There is a risk of an accident.

Do not attach any heavy or large objects to the key. Remove any bulky keyrings before inserting the key into the ignition lock.

- !** Keep the key away from strong magnetic fields. Otherwise, the remote control function could be affected.

Strong magnetic fields can occur in the vicinity of powerful electrical installations.

Do not keep the key:

- with electronic devices, e.g. a mobile phone or another key
- with metallic objects, e.g. coins or metal film
- with metallic objects, e.g. a metal case

#### Only for England:

##### **WARNING**

When the double locks are activated, the doors can no longer be opened from the inside. People in the vehicle can no longer get out, e.g. in hazardous situations. There is a risk of injury.

Therefore, do not leave any people unsupervised in the vehicle, particularly children, elderly people or people in need of special assistance. Do not activate the double lock when people are in the vehicle.



The double-lock function is activated if you press the locking button twice when locking the vehicle. It is then not possible to open the doors from inside the vehicle.

##### **WARNING**

If persons (particularly children) are exposed to heat or cold for a prolonged period, there is a risk of serious or even fatal injuries. Never leave persons (particularly children) unattended in the vehicle.

## Key functions



- ①  Unlocks the vehicle
- ②  Opens the tailgate
- ③  Locks the vehicle

► **To unlock centrally:** press button ①.

If you do not open the vehicle within approximately 2 minutes of unlocking:

- the vehicle is locked again.
- protection against theft is reactivated

► **To unlock and open the tailgate:** press and hold button ② on the key.

► **To lock centrally:** press button ③.

The key centrally locks/unlocks:

- the doors
- the tailgate
- the fuel filler flap

When unlocking, the turn signals flash once. When locking, they flash twice.

### Only for England:

► **To activate the double-lock function:** press button ③ twice.

It is then not possible to open the doors from inside the vehicle.

Upon activation of the double-lock function, the turn signals flash twice long and three times short.

## Battery of the key

### Important safety notes

#### WARNING

Batteries contain toxic and corrosive substances. If batteries are swallowed, it can result in severe health problems. There is a risk of fatal injury.

Keep batteries out of the reach of children. If a battery is swallowed, seek medical attention immediately.

#### Environmental note



Batteries contain pollutants. It is illegal to dispose of them with the household rubbish. They must be collected separately and disposed of in an environmentally responsible recycling system.



Dispose of batteries in an environmentally responsible manner. Take discharged batteries to a qualified specialist workshop or to a collection point for used batteries.

smart recommends that you have the batteries changed at a qualified specialist workshop.

### Replacing the battery

You require a CR 2016 3V cell battery.



- ▶ Remove screw ① turning anti-clockwise using a suitably sized Phillips screwdriver and put in a safe place.





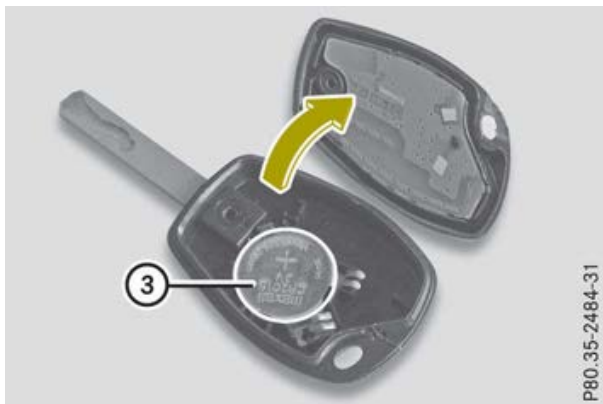

- ▶ Insert a suitable tool, e.g. a coin, into the opening of the key. Turn the tool until battery tray cover ② opens. When doing so, do not hold cover ② shut.
- ▶ Remove battery tray cover ②.



- ▶ Remove battery ③.
- ▶ Insert the new battery with the positive terminal facing upwards. Use a lint-free cloth to do so.
- ▶ Make sure that the surface of the battery is free from lint, grease and all other forms of contamination.
- ▶ Insert battery tray cover ② into the housing and press to close.
- ▶ Replace screw ① and tighten clockwise using a suitably sized Phillips screwdriver.
- ▶ Check the function of all key buttons on the vehicle.

## Problems with the key

Problem	Possible causes/consequences and ► Solutions
<p>You cannot lock or unlock the vehicle using the key.</p>	<p>The key battery is discharged or nearly discharged.</p> <ul style="list-style-type: none"> <li>► Try again to lock/unlock the vehicle using the remote control function of the key. Do this by pressing the  or  button in the immediate vicinity of the vehicle.</li> </ul> <p>If this does not work:</p> <ul style="list-style-type: none"> <li>► Change the key battery if necessary (▷ page 69).</li> <li>► Unlock the vehicle with the key in the emergency lock (▷ page 74) or lock the vehicle with the emergency locking (▷ page 74).</li> </ul> <p>There is interference from a powerful source of radio waves.</p> <ul style="list-style-type: none"> <li>► Try again to lock/unlock the vehicle using the remote control function of the key. Do this by pressing the  or  button in the immediate vicinity of the vehicle.</li> </ul> <p>The key is faulty.</p> <ul style="list-style-type: none"> <li>► Unlock the vehicle with the key in the emergency lock (▷ page 74) or lock the vehicle with the emergency locking (▷ page 74).</li> <li>► Have the key checked at a qualified specialist workshop.</li> </ul>
<p>You have lost a key.</p>	<ul style="list-style-type: none"> <li>► Have the key deactivated at a qualified specialist workshop.</li> <li>► Report the loss immediately to the vehicle insurers.</li> <li>► If necessary, have the locks changed as well.</li> </ul>
<p>The engine cannot be started using the key.</p>	<p>The on-board voltage is too low.</p> <ul style="list-style-type: none"> <li>► Switch off non-essential consumers, e.g. seat heating or interior lighting, and try to start the engine again.</li> </ul> <p>If this does not work:</p> <ul style="list-style-type: none"> <li>► Check the starter battery and charge it if necessary (▷ page 233).</li> </ul> <p>or</p> <ul style="list-style-type: none"> <li>► Jump-start the vehicle (▷ page 236).</li> </ul> <p>or</p> <ul style="list-style-type: none"> <li>► Consult a qualified specialist workshop.</li> </ul> <p>The steering lock is mechanically blocked.</p> <ul style="list-style-type: none"> <li>► Remove the key and reinsert it into the ignition lock. When you turn the key, turn the steering wheel in both directions.</li> </ul>

## Doors

### Important safety notes

#### WARNING

If children are left unsupervised in the vehicle, they could:

- open doors, thereby endangering other persons or road users
- get out and be struck by oncoming traffic
- operate vehicle equipment and become trapped, for example

In addition, the children could also set the vehicle in motion, for example, if they:

- release the parking brake
- shift the automatic transmission out of park position P or shift manual transmission into neutral
- start the engine

There is a risk of an accident and injury.

When leaving the vehicle, always take the key with you and lock the vehicle. Never leave children and animals unattended in the vehicle. Keep the keys out of the reach of children.

Preferably stow luggage or loads in the luggage compartment. Observe the loading guidelines (▷ page 204).

#### Only for England:

#### WARNING

When the double locks are activated, the doors can no longer be opened from the inside. People in the vehicle can no longer get out, e.g. in hazardous situations. There is a risk of injury.

Therefore, do not leave any people unsupervised in the vehicle, particularly children, elderly people or people in need of special assistance. Do not activate the double lock when people are in the vehicle.

If you press the locking button on the key twice when locking the vehicle:

- the turn signals flash twice long and three times short
- the double-lock function is activated

It is then not possible to open the doors from inside the vehicle.

### Unlocking and opening the doors from the inside



- ▶ Pull door handle ①.  
The door opens.

You can open a door from inside the vehicle even if it has been locked.

- ▶ Pull door handle ①.  
The door unlocks and opens.

If the vehicle has previously been locked with the key, opening a door from the inside will trigger the anti-theft alarm system. Switch off the alarm (▷ page 61).

You can only open the rear doors from inside the vehicle if they are not secured by the child-proof locks (▷ page 60).

#### For England only:

If when locking the vehicle you press twice on the locking button on the key:

- the turn signals flash long twice and short three times
- the double-lock function is activated

It is then not possible to open the doors from inside the vehicle.

### Centrally locking or unlocking the vehicle from the inside

You can centrally lock or unlock the vehicle from the inside. This can be useful if you wish to lock the vehicle before pulling away, for example.

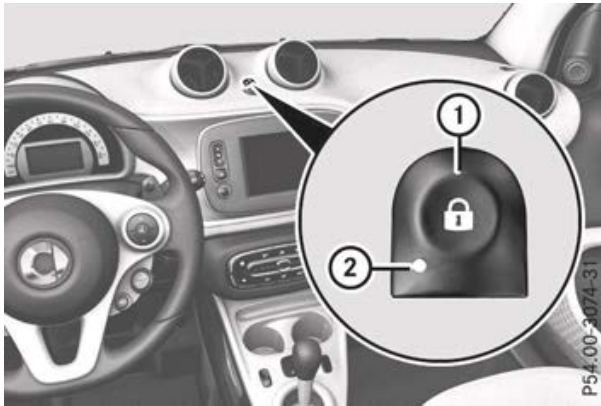

► **To lock:** when the vehicle is unlocked, press button ①.

If all the doors and the tailgate are closed, the vehicle locks. Indicator lamp ② lights up.

► **To lock the vehicle from inside when getting out:** open the driver's door.

The front-passenger door, rear doors and the tailgate must be closed.

► Press the locking button (▷ page 73).

► Close the driver's door within 5 seconds.

Do not leave the key in the vehicle. You could otherwise lock yourself out.

The doors, tailgate and fuel filler flap are locked. The anti-theft alarm system is primed.

► Make sure that the doors and the tailgate are locked.

► **To unlock:** when the vehicle is locked, press button ①.

The vehicle is unlocked. Indicator lamp ② goes out.

You can open a door from inside the vehicle even if it has been locked.

You can open the rear doors from inside the vehicle if they are not secured by the child-proof locks (▷ page 60).

If the vehicle has previously been locked with the key, opening a door from the inside will trigger the anti-theft alarm system. Switch off the alarm (▷ page 61).

If a locked door is opened from the inside, the previous unlocking is taken into account, if:

- it was locked using the locking button for the central locking, or
- it was locked automatically

The vehicle will be fully unlocked if it had previously been fully unlocked. If only the driver's door had been previously unlocked, then only the door which has been opened from the inside is unlocked.

You cannot unlock the vehicle centrally from the inside if the vehicle has been locked with the key.

#### Only for England:

If you press the locking button on the key twice when locking the vehicle:

- the turn signals flash twice long and three times short
- the double-lock function is activated

It is then not possible to open the doors from inside the vehicle.

#### Automatic locking feature



- ▶ **To deactivate:** with the ignition switched on, press and hold button ① for about five seconds until a tone sounds.
- ▶ **To activate** with the ignition switched on, press and hold button ① for about five seconds until a tone sounds.

The vehicle is locked automatically when the ignition is switched on and the wheels are turning.

You could therefore be locked out if:

- the vehicle is being pushed.
- the vehicle is being towed.
- the vehicle is being tested on a dynamometer.

You can also switch the automatic locking function on or off in the smart Media-System; see the separate operating instructions.

#### Unlocking the driver's door (emergency lock)

If you can no longer unlock the vehicle using the remote control key, use the emergency lock.

If you use the key in the emergency lock to unlock and open the driver's door, the anti-theft alarm system will be triggered. Switch off the alarm (▷ page 61).

- ▶ Insert the key into the emergency lock of the driver's door as far as it will go.
- ❗ For right-hand-drive vehicles, the key must be inserted into the emergency lock of the passenger's door.



- ▶ Turn the key clockwise from position ① as far as it will go. The door is unlocked.
- ▶ Turn the key back and remove it.

#### Locking the driver's door (emergency locking)

If you can no longer lock the vehicle using the remote control key, use the locking button on the instrument cluster (▷ page 73).

- ▶ Open the driver's door.
- ▶ Close the front-passenger door, the rear doors and the tailgate.
- ▶ Press the locking button (▷ page 73).
- ▶ Close the driver's door within 5 seconds. Do not leave the key in the vehicle. You could otherwise lock yourself out. The doors, tailgate and fuel filler flap are locked. The anti-theft alarm system is primed.
- ▶ Make sure that the doors and the tailgate are locked.

If this does not work, use the emergency locking.

- ▶ Open the driver's door.
- ▶ Close the front-passenger door, the rear doors and the tailgate.
- ▶ Press the locking button (▷ page 73).
- ▶ Check whether the front-passenger's door and the rear doors are locked. If necessary, carry out the following steps on all doors.

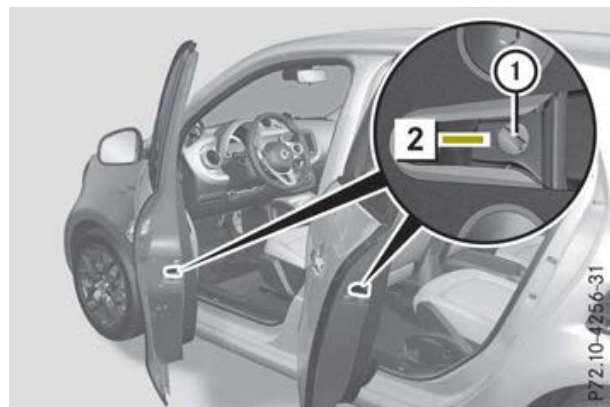

- ▶ Insert the tip of the key into slit ①.
  - ▶ Turn the key anti-clockwise as far as it will go to position 2.
- On the passenger side, the direction of rotation is reversed.
- i** For right-hand-drive vehicles, the key on the driver's side must be turned clockwise, and anti-clockwise on the front-passenger's side.
  - ▶ Close the driver's door.
  - ▶ Check that all the doors are locked.
  - i** If you lock the vehicle using the emergency locking, the tailgate and fuel filler flap are not locked. The anti-theft alarm system is not primed.

## Luggage compartment

### Important safety notes

#### WARNING

Combustion engines emit poisonous exhaust gases such as carbon monoxide. If the tailgate is open when the engine is running, particularly if the vehicle is moving, exhaust fumes could enter the passenger compartment. There is a risk of poisoning.

Turn off the engine before opening the tailgate. Never drive with the tailgate open.

#### WARNING

If objects, luggage or loads are not secured or not secured sufficiently, they could slip, tip over or be flung around and thereby hit vehicle occupants. There is a risk of injury, especially when braking or abruptly changing directions.

Always store objects so that they cannot be flung around. Secure objects, luggage or loads against slipping or tipping before the journey.

- !** The tailgate swings upwards and to the rear when opened. Therefore, make sure that there is sufficient clearance above and behind the tailgate.

- i** The opening dimensions of the tailgate can be found in the "Vehicle data" section (▷ page 273).



Preferably stow luggage or loads in the luggage compartment. Observe the loading guidelines (▷ page 204).

Do not leave the key in the luggage compartment. You could otherwise lock yourself out.

### Opening or closing

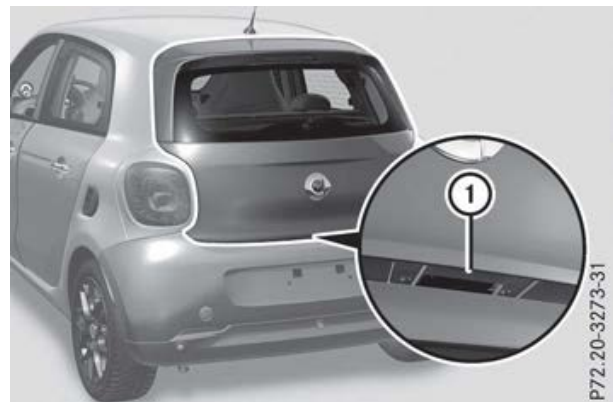
#### Opening the tailgate



- ▶ If the vehicle is locked, first press the  button on the key. Press button ①. The tailgate is unlocked.
- or
- ▶ Press and hold the  button on the key. The tailgate springs up slightly.
- ▶ Lift the tailgate upwards.

## Closing the tailgate



- ▶ Pull the tailgate down and push closed.
- ▶ When leaving the vehicle, lock the vehicle with the  button on the key.
- i** As long as the vehicle is not locked, you can open the tailgate again at any time.

### Tailgate emergency release

- !** The tailgate swings upwards and to the rear when opened. Therefore, make sure that there is sufficient clearance above and behind the tailgate.
- i** The opening dimensions of the tailgate can be found in the "Vehicle data" section (▷ page 273).

If the tailgate can no longer be opened from outside the vehicle, use the emergency release on the inside of the tailgate.

You can reach the emergency release via the luggage compartment.

- ▶ Fold the rear seat backrest forward (▷ page 206).

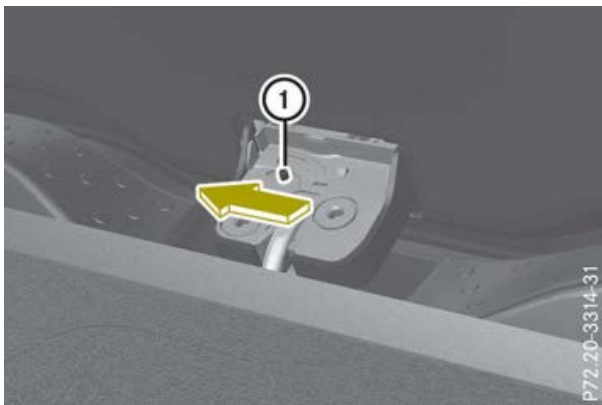

- ▶ Slide emergency release lever  to the left until the tailgate is unlocked.

## Side windows

### Important safety notes

#### WARNING

While closing the side windows, body parts in the closing area could become trapped. There is a risk of injury.

When closing make sure that no parts of the body are in the closing area. If somebody becomes trapped, release the switch or press the switch to open the side window again.

#### WARNING

Children could become trapped if they operate the side windows, particularly when unattended. There is a risk of injury. When leaving the vehicle, always take the key with you and lock the vehicle. Never leave children unattended in the vehicle.

### Front side window reversing feature

In vehicles with the comfort package, the side windows are equipped with an automatic reversing feature. If a solid object blocks or restricts a side window from travelling upwards during the automatic closing process, the side window opens again automatically. During the manual closing process, the side window only opens again automatically after the corresponding switch is released. The automatic reversing feature is only an aid and is no substitute for your attention when closing a side window.

### WARNING

The reversing function does not react:

- to soft, light and thin objects, e.g. small fingers
- while resetting

This means that the reversing feature cannot prevent someone being trapped in these situations. There is a risk of injury.

When closing, make sure that no parts of the body are in the closing area. If someone becomes trapped, press the switch to open the side window again.

### WARNING

If you close a side window again immediately after it has been blocked or reset, the side window closes with increased or maximum force. The reversing function is then not active. Parts of the body could be trapped in the closing area in the process. This poses an increased risk of injury or even fatal injury.

Make sure that no parts of the body are in the closing area. To stop the closing process, release the switch or push the switch again to reopen the side window.

### Opening or closing the front side windows

The switches for both side windows are located on the driver's door. There is also a switch for the front-passenger side window on the front-passenger door.

The switch on the driver's door takes precedence.

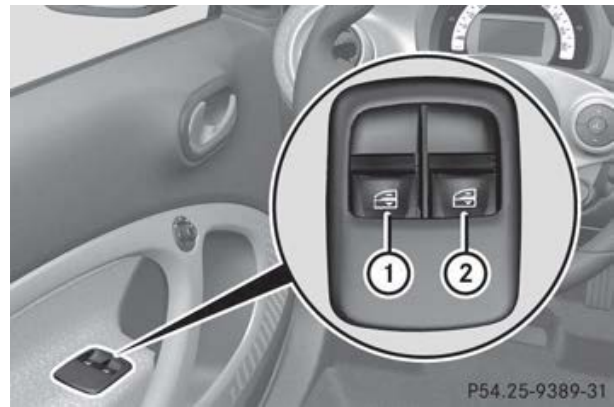

- ① Left
- ② Right

- ▶ Turn the key to position **1** or **2** in the ignition lock.
- ▶ **To open manually:** press and hold the corresponding button.
- ▶ **To open fully:** press the button beyond the point of resistance and release it. Automatic closing is started.
- ▶ **To close manually:** pull the corresponding button and hold it.
- ▶ **Vehicles with the comfort package:**
  - To close fully:** pull the button beyond the point of resistance and release it. Automatic closing is started.
- ▶ **To interrupt automatic opening/closing:** press/pull the corresponding switch again.
- i** If you press the switch beyond the point of resistance while opening, automatic operation is started. In vehicles with the comfort package, you can also start automatic operation when closing. To do so, pull the switch beyond the point of resistance.
 

You can stop automatic operation by pressing again.
- i** You can continue to operate the side windows after turning the key to position **0** in the ignition lock or removing the key. This function remains active for 3 minutes or until you open a door.

### Hinged windows of rear doors

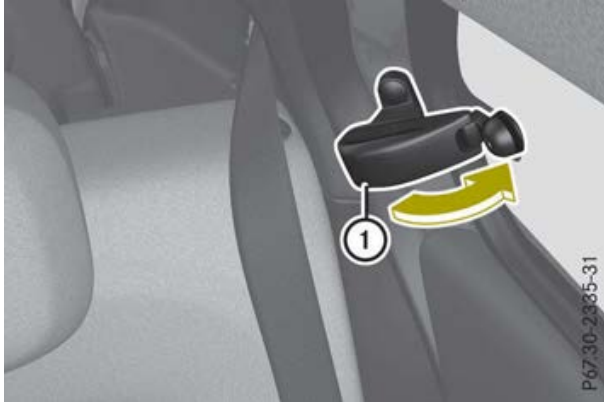

- ▶ **To open:** fold lever ① forwards.
- ▶ Push the hinged window out using lever ① until it engages.
- ▶ Push lever ① back until it engages. The hinged window is fixed.
- ▶ **To close:** fold lever ① forwards.
- ▶ Tilt the hinged window inwards using lever ①.
- ▶ Push lever ① back until it engages.
- ▶ Check, whether the hinged window is locked.

### Resetting the front side windows

You must reset each side window if:

- the side window opens again slightly after being closed fully.
- the side window can no longer be fully opened or closed.
- ▶ Close all doors.
- ▶ Turn the key to position **2** in the ignition lock.
- ▶ Pull the corresponding switch on the door control panel until the side window is completely closed (▷ page 77).
- ▶ Hold the switch for an additional second.

If the side window opens again slightly:

- ▶ Immediately pull the corresponding switch on the door control panel until the

side window is completely closed (▷ page 77).

- ▶ Hold the switch for an additional second.
- ▶ If the corresponding side window remains closed after the button has been released, the side window has been reset correctly. If this is not the case, repeat the steps above again.

P6730-2335-31

## Problems with the front side windows

### WARNING

If you close a side window again immediately after it has been blocked or reset, the side window closes with increased or maximum force. The reversing function is then not active. Parts of the body could be trapped in the closing area in the process. This poses an increased risk of injury or even fatal injury.

Make sure that no parts of the body are in the closing area. To stop the closing process, release the switch or push the switch again to reopen the side window.

Problem	Possible causes/consequences and ► Solutions
A side window cannot be closed because it is blocked by objects, e.g. leaves in the window guide.	<ul style="list-style-type: none"> <li>► Remove the objects.</li> <li>► Close the side window.</li> </ul>
A side window cannot be closed and you cannot see the cause.	<p>If a side window is obstructed during closing and reopens again slightly:</p> <ul style="list-style-type: none"> <li>► Immediately after the window blocks, pull the corresponding switch again until the side window has closed. The side window is closed with increased force.</li> </ul> <p>If a side window is obstructed again during closing and reopens again slightly:</p> <ul style="list-style-type: none"> <li>► Immediately after the window blocks, pull the corresponding switch again until the side window has closed. The side window is closed without the anti-entrapment feature.</li> </ul>

>> Opening and closing.

## Folding top

### Important safety notes

#### WARNING

During opening and closing, body parts in the sweep of the folding top can get trapped. There is a risk of injury.

When opening and closing make sure that no parts of the body are in the sweep.

Release the switch immediately if somebody becomes trapped.

The opening or closing will stop.

#### WARNING

Children could become trapped if they operate the folding top, particularly when unattended. There is a risk of injury.

When leaving the vehicle, always take the key with you and lock the vehicle. Never leave children unattended in the vehicle.

**!** Only open the folding top if it is free of snow and ice. Otherwise, malfunctions may occur.

Do not allow anything to protrude from the folding top. Otherwise, the seals could be damaged.

## Opening or closing the folding top

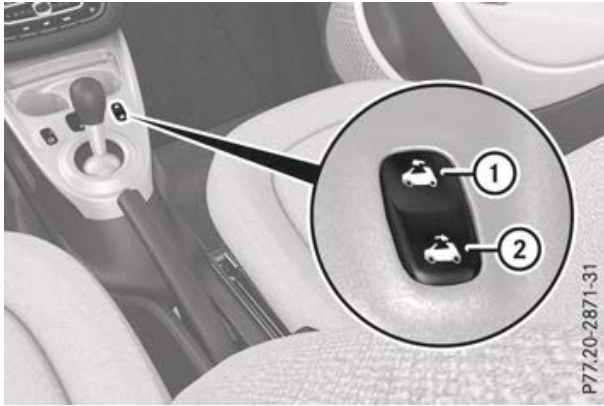

- ① To close
- ② To open

## >> Opening and closing.

- ▶ Turn the key to position **1** or **2** in the ignition lock (▷ page 121).
- ▶ **To open:** press and hold the folding top switch at position ② until the folding top is in the desired position.
- ▶ **To close:** press and hold the folding top switch at position ① until the folding top is completely closed.
- i** It is possible to open or close the folding top while driving up to a maximum speed of 100 km/h.

## Problems with the folding top

Problem	Possible causes/consequences and ► Solutions
The folding top cannot be closed and you cannot see the cause.	<p>If the folding top is obstructed during closing and reopens again slightly:</p> <ul style="list-style-type: none"> <li>► Immediately after it is obstructed, press and hold the top part of the folding top switch again until the folding top is fully closed.</li> </ul> <p>The folding top is closed with increased force.</p>

- i** If the power supply is not sufficient, the folding top cannot be closed. In this case, either charge the battery (▷ page 235) or jump-start the vehicle (▷ page 236).

## Operating the roller sunblinds for the panoramic roof

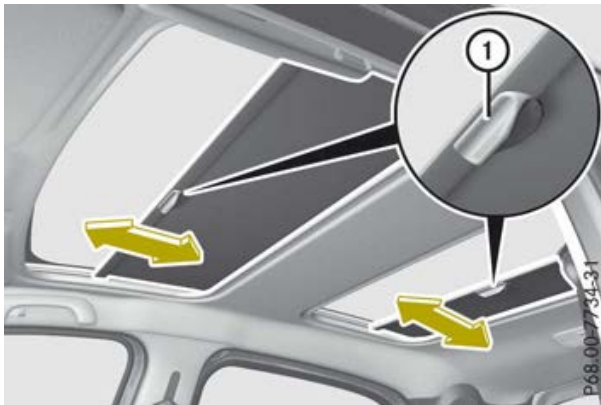

The roller sunblinds shield the vehicle interior from sunlight.

- **To open:** press the roller sunblind up by the outer edge of handle ① and slide it backwards.
- **To close:** pull the roller sunblind forward by the outer edge of handle ① until it engages.



Useful information ..... 84  
Correct driver's seat position ..... 84  
Seats ..... 85  
Steering wheel ..... 89  
Mirrors ..... 90

>> Seats, steering wheel and mirrors.

### Useful information

- i** This Owner's Manual describes all models, series and optional equipment for your vehicle that were available at the time of going to press. Country-specific differences are possible. Note that your vehicle may not be fitted with all features described. This is also the case for systems and functions relevant to safety.
- i** Read the information on qualified specialist workshops: (▷ page 21).

### Correct driver's seat position

#### WARNING

You could lose control of the vehicle while driving if you:

- adjust the driver's seat, steering wheel or mirror
- fasten the seat belt.

There is a risk of an accident.

Adjust the driver's seat, steering wheel or mirror and fasten the seat belt before starting the engine.



Example

Observe the safety guidelines on seat adjustment (▷ page 85).

- ▶ Make sure that seat ③ is adjusted properly.

Adjusting the seat (▷ page 86)

When adjusting the seat, make sure that:

- you are as far away from the driver's airbag as possible.
- you are sitting in a normal upright position.
- you can fasten the seat belt properly.
- you have moved the backrest to an almost vertical position.
- you can depress the pedals properly.

Observe the safety guidelines on steering wheel adjustment (▷ page 89).

- ▶ Make sure that steering wheel ① is adjusted properly.

Adjusts the steering wheel (▷ page 89)

When adjusting the steering wheel, make sure that:

- you can hold the steering wheel with your arms slightly bent.
- you can move your legs freely.
- you can see all the displays in the instrument cluster clearly.

Observe the safety guidelines for seat belts (▷ page 40).

- ▶ Check whether you have fastened seat belt ② properly (▷ page 42).

The seat belt should:

- fit snugly across your body
- be routed across the middle of your shoulder
- be routed in your pelvic area across the hip joints
- ▶ Before starting off, adjust the rear-view mirror and the exterior mirrors (▷ page 90) in such a way that you have a good view of road and traffic conditions.

P91.40-3446-31

## Seats

## Important safety notes

 **WARNING**

If children adjust the seats, they could become trapped, especially if they are unattended. There is a risk of injury.

When leaving the vehicle, always take the key with you and lock the vehicle. Never leave children unattended in the vehicle.

 **WARNING**

If the driver's seat is not correctly engaged, it could unexpectedly move while driving. This could cause you to lose control of the vehicle. There is a risk of an accident.

Always ensure that the driver's seat is engaged before starting the vehicle.

 **WARNING**

You could lose control of the vehicle while driving if you:

- adjust the driver's seat, steering wheel or mirror
- fasten the seat belt.

There is a risk of an accident.

Adjust the driver's seat, steering wheel or mirror and fasten the seat belt before starting the engine.

 **WARNING**

When adjusting a seat, you or another vehicle occupant could become trapped by the guide rail of the seat, for instance. There is a risk of injury.

Make sure that no one has any part of their body within the sweep of the seat when adjusting it.

 **WARNING**

The seat belt does not offer the intended level of protection if you have not moved the backrest to an almost vertical position. When braking or in the event of an accident,

you could slide underneath the seat belt and sustain abdomen or neck injuries, for example. This poses an increased risk of injury or even fatal injury.

Adjust the seat properly before beginning your journey. Always ensure that the backrest is in an almost vertical position and that the shoulder section of your seatbelt is routed across the centre of your shoulder.

Observe the safety notes on "Airbags" (▷ page 44) and "Children in the vehicle" (▷ page 47).

**!** To avoid damage to the seats and the seat heating, observe the following information:

- do not spill any liquids on the seats. If liquid is spilled on the seats, dry them as soon as possible.
- if the seat covers are damp or wet, do not switch on the seat heating. The seat heating should also not be used to dry the seats.
- clean the seat covers as recommended; see the "Interior care" section.
- do not transport heavy loads on the seats. Do not place sharp objects on the seat cushions, e.g. knives, nails or tools. The seats should only be occupied by passengers, if possible.
- when the seat heating is in operation, do not cover the seats with insulating materials, e.g. blankets, coats, bags, seat covers, child seats or booster seats.

**!** Make sure that there are no objects in the footwell under or behind the seats when moving the seats back. There is a risk that the seats and/or the objects could be damaged.

### Adjusting the seat



Illustration of variant 1

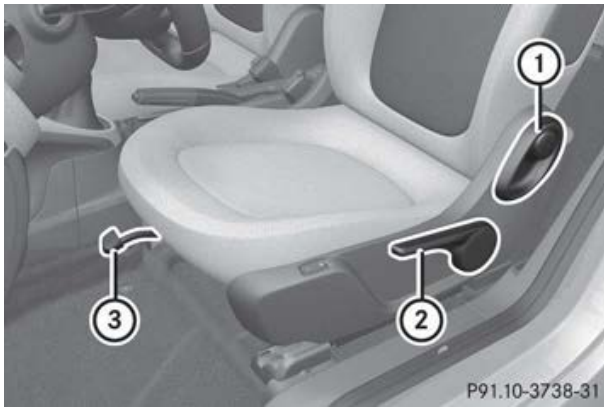

Illustration of variant 2

### Seat fore-and-aft adjustment

- ▶ Lift handle (3) and slide the seat forwards or rearwards.
- ▶ Release lever (3) again.  
Make sure that you hear the seat engage in position.

### Backrest angle

#### Variant 1

- ▶ Relieve the pressure on the backrest.
- ▶ Turn handwheel (1) forwards or backwards.

#### Variant 2

- ▶ Relieve the pressure on the backrest.
- ▶ Pull release lever (1).  
The backrest is released.

- ▶ Move the backrest forwards or backwards.
- ▶ Let go of release lever (1) again.

### Seat height<sup>4</sup>

- ▶ **Only variant 2:** pull handle (2) up or push it down repeatedly until the seat has reached the desired height.

### Folding down the front-passenger seat

You can increase the size of the luggage compartment by folding the front-passenger seat backrest forwards.

Observe the loading guidelines (▷ page 204) and the notes in the "Child restraint system on the front-passenger seat" section (▷ page 52).

### Folding down



Illustration of variant 1



Illustration of variant 2

<sup>4</sup> Only driver's seat, depending on equipment.

**Variant 1:**

- ▶ Slide the right-hand front seat to its rearmost position.
- ▶ Turn handwheel ① forward until the desired seat backrest position is achieved

**Variant 2:**

- ▶ Slide the right-hand front seat to its rearmost position.
- ▶ Hold onto the backrest at the head restraint with one hand.
- ▶ Pull release lever ①.  
The backrest is released.
- ▶ Fold the backrest forwards.

**Folding back****⚠ WARNING**

If the seat backrest is not engaged, it may fold forwards, e.g. during braking or in the event of an accident.

- As a result, a backrest which is not engaged would press you into the seat belt. The seat belt cannot perform its intended protective function and could additionally cause injury.
- The backrest cannot restrain objects or loads in the boot.

This poses an increased risk of injury.

Before every journey, make sure that the backrest is engaged as described.

**Variant 1:**

- ▶ Turn handwheel ① back until the desired seat backrest position is achieved

**Variant 2:**

- ▶ Pull release lever ①.  
The backrest is released.
- ▶ Fold the backrest backwards.
- ▶ Ensure that the seat backrest is engaged again.

**Stowing head restraints in the rear compartment****Important safety notes****⚠ WARNING**

You could lose control of the vehicle while driving if you:

- adjust the driver's seat, steering wheel or mirrors
- fasten the seat belt

There is a risk of an accident.

Adjust the driver's seat, head restraint, steering wheel and mirrors and fasten your seat belt before starting the engine.

**⚠ WARNING**

The head restraints cannot provide the intended protection unless they are fitted and adjusted correctly. There is an increased risk of injury to the head and neck in the event of an accident or sudden braking, for example.

Always drive with the head restraints fitted. Ensure that the centre of the head restraints support the back of each vehicle occupant's head at eye level before driving off.

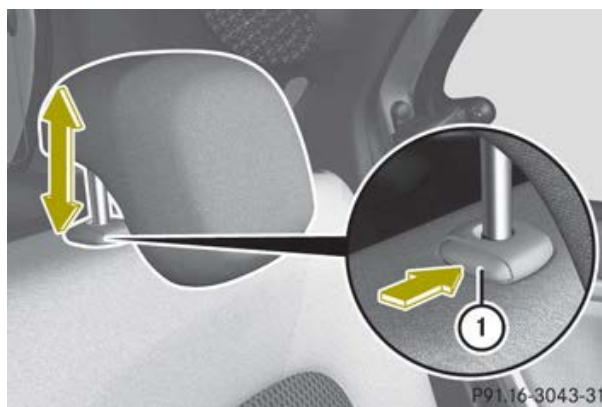
**Adjusting the head restraints**

The head restraints can be adjusted to the in-use position. When the rear seats are occupied, use this position. The rest position of the head restraints is used, e.g. when you wish to fold the rear seat backrests forwards.

- ▶ **To raise (in-use position):** pull the head restraint up until the head restraint engages.
- ▶ **To lower (rest position):** press release catch ① and push the head restraint down.

▶ Turn the key to position **2** in the ignition lock (▷ page 121).

▶ **To switch on:** press button ②. Indicator lamp ① in the button lights up.

▶ **To switch off:** press button ②. Indicator lamp ① in the button goes out.

**i** If the battery voltage is too low, the seat heating may switch off.

The seat heating switches off automatically after about 10 minutes.

### Switching the seat heating on/off

#### Switching on/off

#### WARNING

If you repeatedly switch on seat heating, the seat cushion and backrest padding may become very hot. The health of vehicle occupants with limited temperature sensitivity or a limited ability to react to excessively high temperatures may be affected or they may even suffer burn-like injuries. There is a risk of injury.

Therefore, do not switch on the seat heating repeatedly.

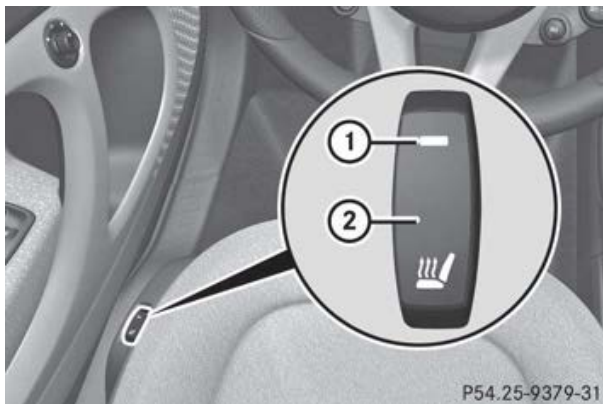

P54.25-9379-31

## Problems with the seat heating

Problem	Possible causes/consequences and ► Solutions
The seat heating has switched off prematurely or cannot be switched on.	<p>The on-board voltage is too low because too many electrical consumers are switched on.</p> <p>► Switch off electrical consumers that you do not need, such as the rear window heating or interior lighting.</p> <p>Once the battery is sufficiently charged, the seat heating will switch back on automatically.</p>

## Steering wheel

### Important safety notes

#### WARNING

You could lose control of the vehicle while driving if you:

- adjust the driver's seat, steering wheel or mirror
- fasten the seat belt.

There is a risk of an accident.

Adjust the driver's seat, steering wheel or mirror and fasten the seat belt before starting the engine.

#### WARNING

Children could become trapped by the steering wheel if they adjust it. There is a risk of injury.

When leaving the vehicle, always take the key with you and lock the vehicle. Never leave children unattended in the vehicle.

### Adjusting the steering wheel

#### WARNING

The steering wheel may move unexpectedly if you adjust it while driving. This could cause you to lose control of the vehicle. There is a risk of an accident.

Make sure that the steering wheel is locked before driving off. Never unlock the steering wheel when the vehicle is in motion.

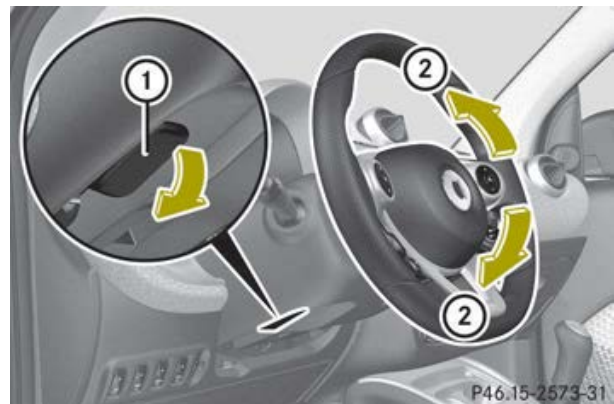

① Release lever

② To adjust the steering wheel height

- Push release lever ① down completely. The steering column is unlocked.
- Set desired steering wheel height ②.
- Push release lever ① up completely. The steering column is locked.
- Check if the steering column is locked. To do so, try and push the steering wheel up or down.

## Mirrors

### Rear-view mirror



- ▶ **Anti-dazzle mode:** pivot anti-dazzle switch ① forwards or back.

### Exterior mirrors

#### Important safety notes

##### ⚠ WARNING

You could lose control of the vehicle while driving if you:

- adjust the driver's seat, steering wheel or mirror
- fasten the seat belt.

There is a risk of an accident.

Adjust the driver's seat, steering wheel or mirror and fasten the seat belt before starting the engine.

##### ⚠ WARNING

The exterior mirrors reduce the size of the image. Objects visible in the mirrors are closer than they appear. You could misjudge the distance from road users driving behind you when changing lanes, for instance. There is a risk of an accident.

You should therefore always look over your shoulder to determine the actual distance from road users driving behind you.

## Adjusting the exterior mirrors manually



- ▶ **To adjust the mirror:** move lever ① to the right or left, up or down.

## Adjusting the exterior mirrors electrically

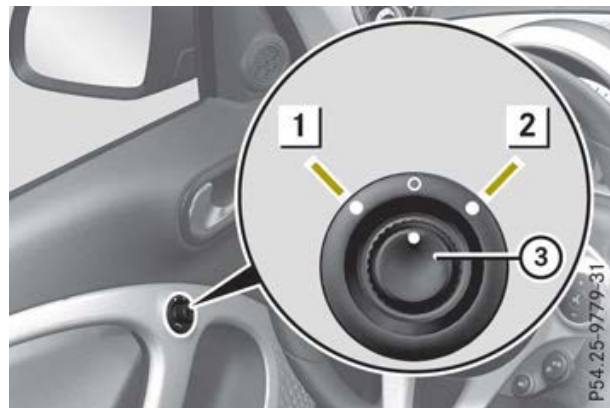

- ▶ Turn the key to position **1** or **2** in the ignition (▷ page 121).
- ▶ **To select an exterior mirror:** turn control ③ to position **1** for the left exterior mirror or to position **2** for the right exterior mirror.
- ▶ **To adjust the mirror:** move control ③ to the right or left, up or down.

The exterior mirrors can be heated by switching on the rear window heating (▷ page 115).

## Exterior mirror pushed out of position

If an exterior mirror has been pushed forwards or backwards out of position, push the exterior mirror into the correct position manually.

Useful information ..... 92  
Exterior lighting ..... 92  
Interior lighting ..... 96  
Replacing bulbs ..... 97  
Windscreen wipers ..... 101

### Useful information

- i** This Owner's Manual describes all models, series and optional equipment for your vehicle that were available at the time of going to press. Country-specific differences are possible. Note that your vehicle may not be fitted with all features described. This is also the case for systems and functions relevant to safety.
- i** Read the information on qualified specialist workshops: (▷ page 21).

### Exterior lighting

#### General notes

For reasons of safety, smart recommends that you drive with the lights switched on even during the daytime. In some countries, operation of the headlamps varies due to legal requirements and self-imposed obligations.

#### Driving abroad

#### General notes

If your journey takes you to countries where vehicles are driven on the opposite side of the road to the country in which the vehicle is registered, your headlamps must be switched to symmetrical dipped beam as soon as possible after crossing the border. This prevents oncoming traffic from being dazzled. Symmetrical lights do not illuminate as large an area of the edge of the carriageway.

### Converting to symmetrical dipped beam

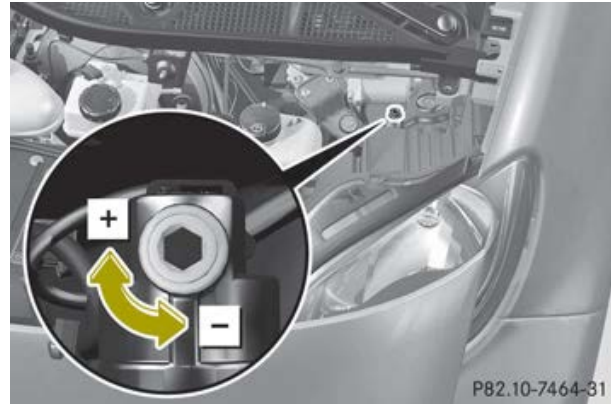

- ▶ Open the service cover (▷ page 216).
- ▶ Turn the screw with an appropriate tool one quarter of a turn toward .

Have the correct setting of the dipped beam headlamps checked at a qualified specialist workshop.

### Converting to asymmetrical dipped beam after returning

Convert the headlamps back to asymmetrical dipped beam as soon as possible after crossing the border.

- ▶ Open the service cover (▷ page 216).
- ▶ Turn the screw with an appropriate tool one quarter of a turn toward  to the original position.

Have the correct setting of the dipped-beam headlamps checked at a qualified specialist workshop.

**Exterior lighting settings**

**Operation**

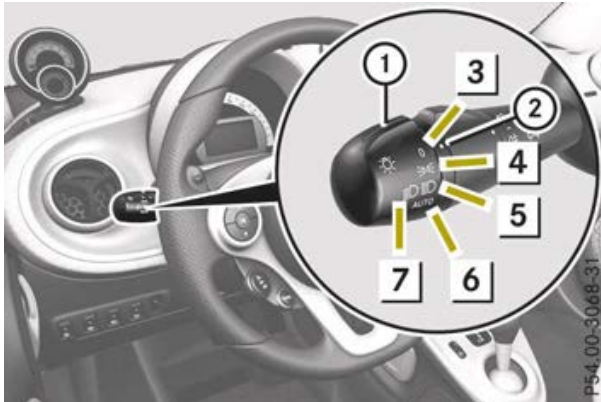

- ① Combination switch control
- ② Marking
- ③ 0 Lights off
- ④ Side lamp, parking lamp, licence plate lighting
- ⑤ Main-beam headlamps
- ⑥ **AUTO** Automatic headlamp mode, controlled by the light sensor
- ⑦ Dipped-beam headlamps

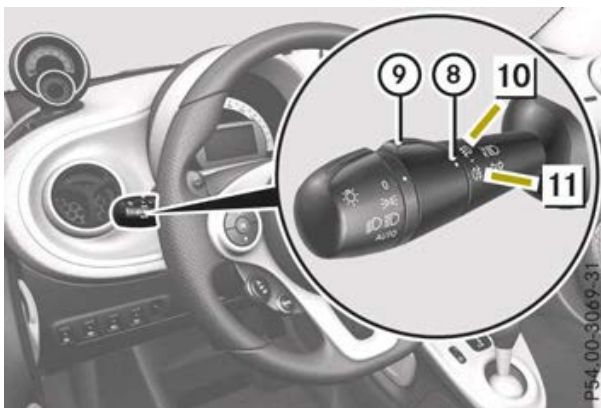

- ⑧ Marking
- ⑨ Combination switch middle ring
- ⑩ Foglamps
- ⑪ Rear foglamp

If you hear a warning tone when you leave the vehicle, the lights may still be switched on.

- Turn combination switch control ① until **AUTO** or **0** is at marking ②.

When in the **AUTO** position the exterior lighting switches off automatically if you:

- switch off the engine
- open the driver's door
- lock the vehicle
- do not switch on the main-beam headlamps

**Automatic headlamp mode**

**AUTO** is the preferred light switch setting. The light setting is automatically selected according to the brightness of the ambient light (exception: poor visibility due to weather conditions such as fog, snow or spray):

- With the engine running: depending on the ambient light conditions, the daytime driving lights or the side lamps or dipped-beam headlamps are switched on or off automatically.

- **To switch on automatic headlamp mode:** turn combination switch control ① until **AUTO** is at marking ②.

**⚠ WARNING**

When the light switch is set to **AUTO**, the dipped-beam headlamps may not be switched on automatically if there is fog, snow or other causes of poor visibility due to the weather conditions such as spray. There is a risk of an accident.

In such situations, turn the light switch to .



The automatic headlamp feature is only an aid. The driver is responsible for the vehicle's lighting at all times.

The daytime driving lights improve the detectability of your vehicle during the day.

When the dipped-beam headlamps are switched on, the indicator lamp in the instrument cluster lights up and the daytime driving lights switch off.

**>> Lights and windscreen wipers.**

### Dipped-beam headlamps





- ▶ **To switch on:** turn combination switch control ① until  is at marking ②. The  indicator lamp in the instrument cluster lights up.

### Side lamps





- ▶ **To switch on:** turn combination switch control ① until  is at marking ②.

### Foglamps

Only vehicles with front foglamps have the "Foglamps" function.

- ▶ **To switch on:** make sure that the side lamps or dipped-beam headlamps are switched on.
  - ▶ Turn combination switch middle ring ⑨ until marking ⑧ is at . The  indicator lamp in the instrument cluster lights up. After releasing, the middle ring returns automatically back to the neutral position.
  - ▶ **To switch off:** turn combination switch middle ring ⑨ until marking ⑧ is at . The  indicator lamp in the instrument cluster goes out. After releasing, the middle ring returns automatically back to the neutral position.
- i** If you switch off the engine (only in the **AUTO** position) or turn off the lights, the foglamps are also switched off.

### Rear foglamp

- ▶ **To switch on:** make sure that the side lamps or dipped-beam headlamps are switched on.
  - ▶ Turn combination switch middle ring ⑨ until marking ⑧ is at . The  indicator lamp in the instrument cluster lights up. After releasing, the middle ring returns automatically back to the neutral position.
  - ▶ **To switch off:** turn combination switch middle ring ⑨ until marking ⑧ is at . The  indicator lamp in the instrument cluster goes out. After releasing, the middle ring returns automatically back to the neutral position.
- i** If you switch off the engine (only in the **AUTO** position) or turn off the lights, the rear foglamps are also switched off.

### Adjusting the headlamp range

The headlamp range control allows you to adjust the cone of light from the headlamps to suit the vehicle load. The cone of light changes when seats are occupied or when the luggage compartment is loaded or unloaded. This can impair visibility and dazzle oncoming traffic.



- 0 Driver's seat is occupied or driver's seat and front-passenger seat are occupied
  - 1 All seats are occupied
  - 2 All seats are occupied and luggage compartment laden
  - 3 Driver's seat is occupied and luggage compartment is laden
  - 4 This setting is not required
- ▶ Turn the key to position **2** in the ignition lock or start the engine.
  - ▶ Turn headlamp range control ① to the position which corresponds to the load in your vehicle.

### Switching on the turn signals

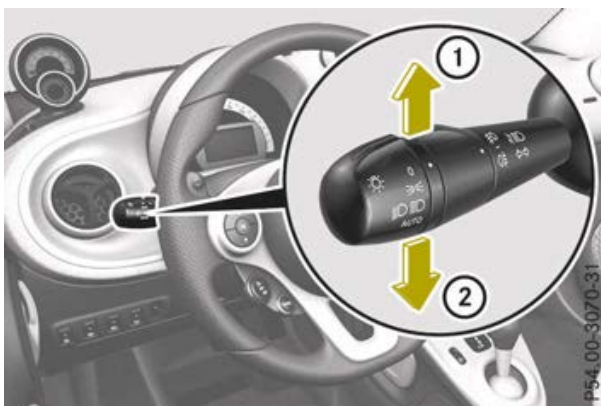

- ▶ Start the engine.
- ▶ **To indicate briefly:** press the combination switch briefly to the pressure point



in the direction of arrow ① (right turn signal) or ② (left turn signal). The corresponding turn signal flashes three times.

- ▶ **To indicate:** press the combination switch beyond the pressure point in the direction of arrow ① (right turn signal) or ② (left turn signal).

### Switching on the main-beam headlamps and headlamp flasher

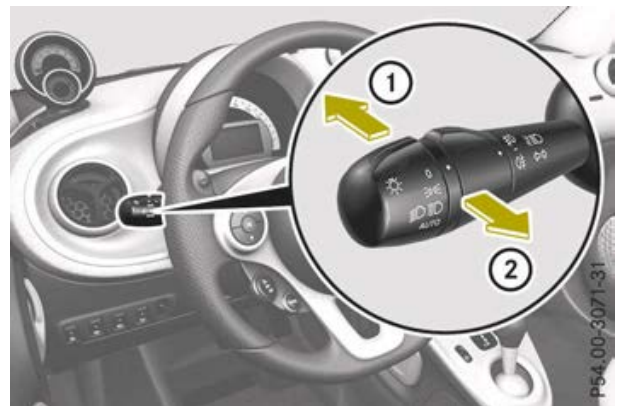
#### Main-beam headlamps



- ▶ **To switch on:** start the engine.
- ▶ Turn the combination switch control until  or **AUTO** (if available) is at the marking.
- ▶ Press the combination switch beyond the pressure point in the direction of arrow ①. The  indicator lamp in the instrument cluster lights up.
- ▶ **To deactivate:** move combination switch ① back to its normal position. The  indicator lamp in the instrument cluster goes out.

#### Headlamp flasher

- ▶ **To switch on:** pull the combination switch in the direction of arrow ②.

### Hazard warning lamps



The hazard warning lamps automatically switch on if:

- an airbag is deployed
- the vehicle decelerates rapidly from a speed of above 70 km/h and comes to a standstill

► **To switch on the hazard warning lamps:** press button ①.

All turn signals flash. If you now switch on a turn signal using the combination switch, only the turn signal lamp on the corresponding side of the vehicle will flash.

► **To switch off the hazard warning lamps:** press button ①.

The hazard warning lamps switch off automatically if the vehicle reaches a speed of above 10 km/h again after a full brake application.

- ❗ The hazard warning lamps still operate if the ignition is switched off.

### Headlamps misted up on the inside

Certain climatic and physical conditions may cause moisture to form in the headlamp. This moisture does not affect the functionality of the headlamp.

## Interior lighting

### Overview

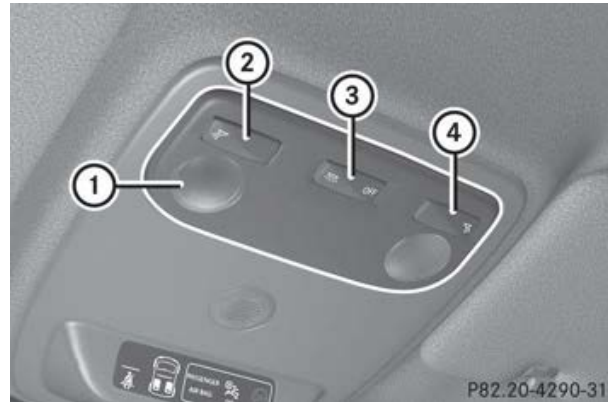

- ① Interior lighting
- ② Switches the left-hand reading lamp on/off
- ③ Depending on the position of the switch:  
Interior lighting switched on  
Automatic interior lighting control on  
Interior lighting switched off
- ④ Switches the right-hand reading lamp on/off

The interior lighting is switched on when a door is open: if the corresponding door is closed correctly the interior lighting goes out.

### Interior lighting control

If the doors are unlocked with the remote control, the interval timer for the interior lighting is triggered. The interval timer restarts when a door is opened.

The front interior lighting and the luggage compartment light go out gradually.

The interior lighting interval timer is switched off:

- if a door remains open, the interior lighting switches off after 15 minutes without dimming
- if all doors (with additional locking mechanism) are closed, the interior lighting switches off after 15 seconds

- if all doors (without locking mechanism) are closed, the interior lighting switches off after 3 to 4 minutes
- as soon as the engine is started and for as long as the engine is running

## Replacing bulbs

### Important safety notes

#### WARNING

Bulbs, lamps and plug connectors can become very hot during use. When replacing a bulb, you could burn yourself on these components. There is a risk of injury.

Allow these components to cool down before replacing the bulb.

Do not use a bulb that has been dropped or if its glass tube has been scratched.

The bulb may explode if:

- you touch it
- it is hot
- you drop it
- you scratch it

Only operate bulbs in enclosed lamps designed for that purpose. Only fit spare bulbs of the same type and the specified voltage.

Marks on the glass tube reduce the service life of the bulbs. Do not touch the glass tube with your bare hands. If necessary, clean the glass tube when cold with alcohol or spirit and rub it off with a lint-free cloth. Protect bulbs from moisture during operation. Do not allow bulbs to come into contact with liquids.

Replace only the bulbs listed (▷ page 97). If you require assistance replacing bulbs, consult a qualified specialist workshop.

If the new bulb still does not light up, consult a qualified specialist workshop.

The daytime driving lights and part of the rear light clusters of your vehicle are equipped with LED light bulbs. Do not

replace these bulbs yourself. Contact a qualified specialist workshop which has the necessary specialist knowledge and tools to carry out the work required.

Headlamps and lamps are an important aspect of vehicle safety. You must therefore make sure that these function correctly at all times. Have the headlamp setting checked regularly.

### Overview of bulb replacement – bulbs

You can replace the following bulbs. The details for the bulb type can be found in the legend.

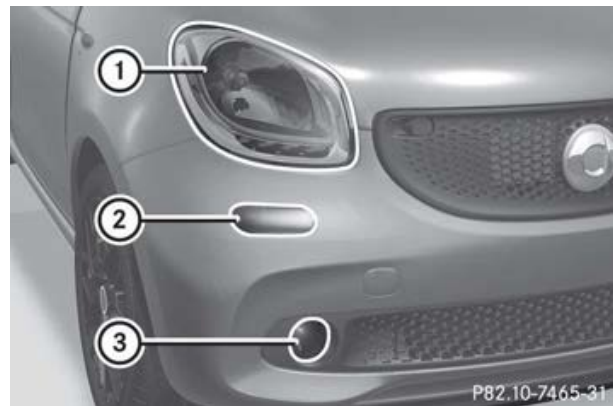

- ① Dipped-beam/main-beam headlamp: H4 60/55 W
- ② Turn signal lamp: PY 21 W
- ③ Foglamps: H16

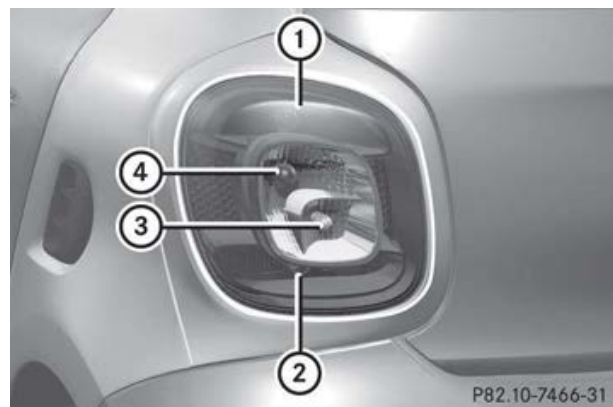

Tail lamps

- ① Tail lamp/brake lamp: P 21 5 W
- ② Rear foglamp: P 21 W
- ③ Reversing lamp: W 16 W
- ④ Turn signal lamp: PY 21 W

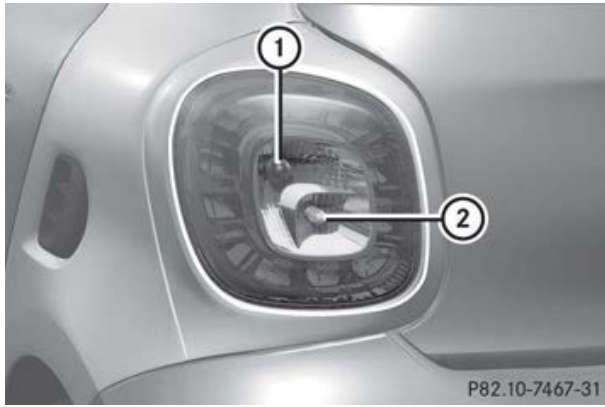

Tail lamps (vehicles with partial LEDs)

- ① Turn signal lamp: PY 21 W
- ② Reversing lamp: W 16 W

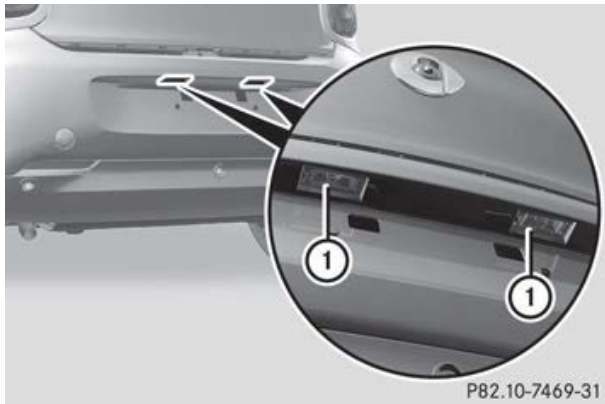

- ① Licence plate lighting: W 5 W

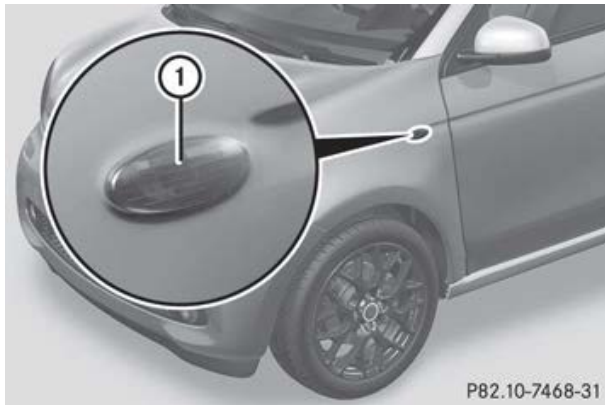

- ① Side turn signal lamps: WY 5 W

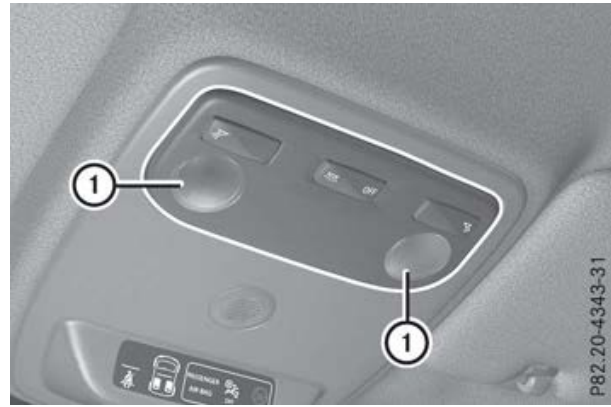

- ① Interior lighting: W 5 W

## Replacing the front bulbs

### Turn signals



- ▶ **To remove the cover in the front wheel arch:** switch off the lighting system.
- ▶ Turn the front wheels inwards.
- ▶ Press spring clip ① down.
- ▶ Slide cover ② back and remove it.



- ▶ Turn bulb holder ① anti-clockwise and remove.
- ▶ Take the bulb out of bulb holder ①.
- ▶ Insert the new bulb into bulb holder ①.
- ▶ Insert bulb holder ① and turn it clockwise until it engages.
- ▶ **To fit the cover in the front wheel arch:** insert cover ② again and lock in place.

### Dipped-beam/main-beam headlamps

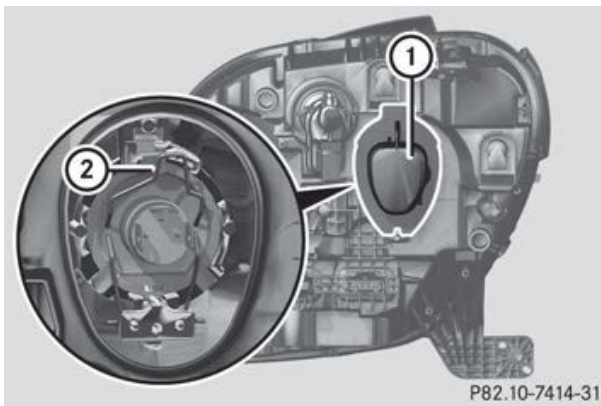

- ▶ Switch off the lights.
- ▶ Open the service cover (▷ page 216).
- ▶ Remove cover ①.
- ▶ Pull out the connector.
- ▶ Simultaneously press retainer ② forward and to the right and then remove the lamp.
- ▶ Insert the new bulb and engage it in place.
- ▶ Insert the connector.
- ▶ Position cover ① and press into place.

### Front foglamps

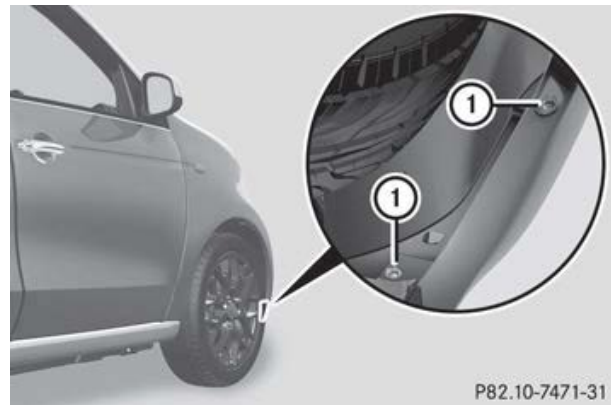

Due to their location, have the bulbs in the front foglamps changed at a qualified specialist workshop.

- ▶ Switch off the lights.
- ▶ Remove the two screws ① at the bottom of the front wheel arch using a suitable tool.
- ▶ Bend back the cover using your hand.
- ▶ Turn the bulb holder anti-clockwise and remove it.
- ▶ Take the bulb out of the bulb holder.
- ▶ Insert the new bulb into the bulb holder.
- ▶ Insert the bulb holder and turn it clockwise until it engages.
- ▶ Bend the cover back into position.
- ▶ Tighten the two screws ① again.

### Side turn signal lamps

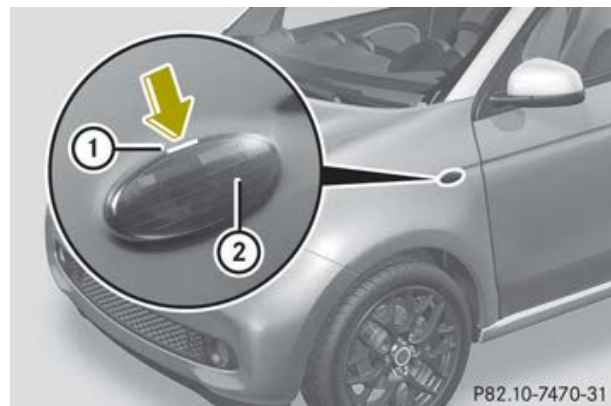

>> Lights and windscreen wipers.

- ▶ Insert a flat tool into recess ① and lever side turn signal lamp ② forwards and out.
- ▶ Remove the bulb holder from side turn signal lamp ② by turning it a quarter turn anti-clockwise.
- ▶ Pull the bulb out of the bulb holder.
- ▶ Insert the new bulb into the bulb holder.
- ▶ Insert the bulb holder into side turn signal lamp ② and turn it a quarter turn clockwise.
- ▶ Insert side turn signal lamp ②.

### Replacing the rear bulbs

#### Tail lamps

- ▶ Switch off the lights.
- ▶ **To remove:** open the tailgate (▷ page 75).

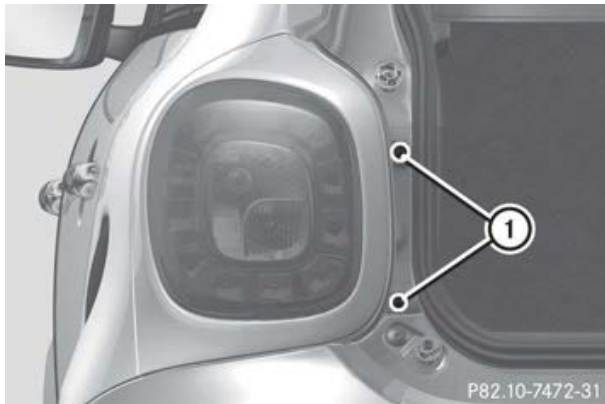

- ▶ Remove two screws ① on the tail lamp using a suitable slotted screwdriver.
- ▶ Carefully take out the lamp.
- ▶ To release the connector: insert a suitable slotted screwdriver under the plastic hanger, lift a small plastic piece upwards and remove the connector.

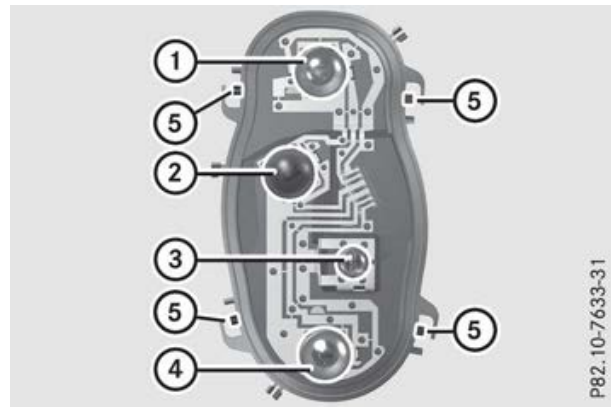

#### Bulb holder

- ① Tail lamp/brake lamp (vehicles without partial LEDs)
- ② Turn signals
- ③ Reversing lamp
- ④ Rear foglamp (vehicles without partial LEDs)

- ▶ Unclip four bulb holder tabs ⑤ and carefully remove the bulb holder.
- ▶ Pull out the corresponding bulb.
- ▶ Insert the new bulb.
- ▶ Insert the bulb holder again. Four bulb holder tabs ⑤ must audibly engage.
- ▶ Insert the connector.
- ▶ Insert the lamp again.
- ▶ Tighten the two screws ① on the tail lamp again.

#### Licence plate lighting

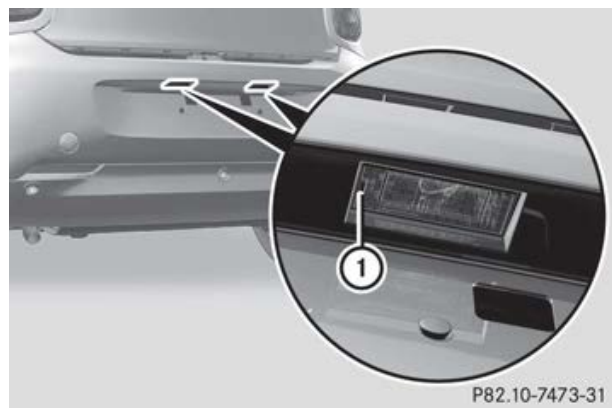

- ▶ **To remove:** release catch ① of the lamp lens using a suitable tool.
- ▶ Remove the lamp lens.

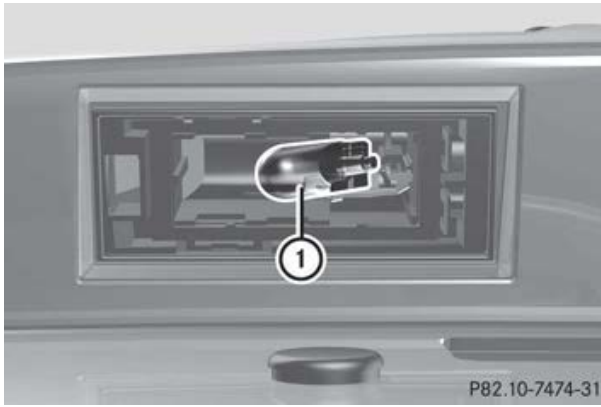

- ▶ Take bulb ① out of the bulb holder.
- ▶ Insert the new bulb into the bulb holder.
- ▶ Re-insert the lamp lens into the licence plate lamp.

**Replacing the interior lighting**



- ▶ Remove lamp lens ① with a flat tool, e.g. a screwdriver.
- ▶ Take the bulb to be replaced out of the bulb holder.
- ▶ Insert the new bulb into the bulb holder.
- ▶ Insert lamp lens ①.

**Windscreen wipers**

**Switching the windscreen wipers on/off**

❗ Do not operate the windscreen wipers when the windscreen is dry, as this could damage the wiper blades. Moreover, dust that has collected on the windscreen can

scratch the glass if wiping takes place when the windscreen is dry.

If it is necessary to switch on the windscreen wipers in dry weather conditions, always operate them using washer fluid.

❗ If the windscreen wipers leave smears on the windscreen after the vehicle has been washed in an automatic car wash, this may be due to wax or other residue. Clean the windscreen with washer fluid after an automatic car wash.

❗ Vehicles with a rain sensor: if the windscreen becomes dirty in dry weather conditions, the windscreen wipers may be activated inadvertently. This could damage the windscreen wiper blades or scratch the windscreen.

For this reason, you should always switch off the windscreen wipers in dry weather.

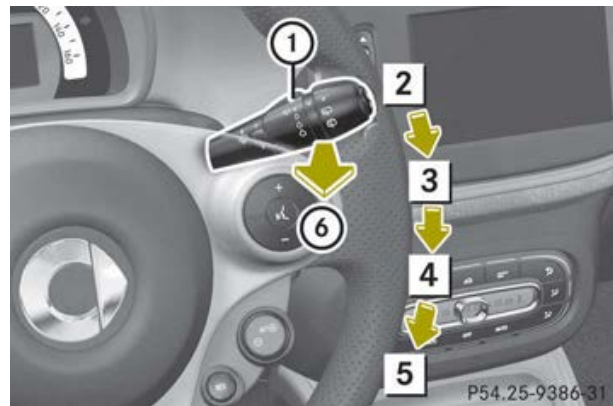

Combination switch

- ① Control for wiping frequency and sensitivity of the rain sensor
- ② 0 Windscreen wipers off
- ③ Intermittent wipe  
**AUTO** Automatic wipe (rain sensor)
- ④ 1 Continuous wipe, slow
- ⑤ 2 Continuous wipe, fast
- ⑥ Wipes with washer fluid

▶ **To switch on:** turn the key to position 1 or 2 in the ignition lock (▷ page 121).

▶ Press the combination switch to the position or 1.

or

» Lights and windscreen wipers.

- ▶ Start the engine (▷ page 121).
- ▶ Press the combination switch down or up to the corresponding position.
- ▶ To wipe with washer fluid : pull the combination switch towards the steering wheel.
- ▶ **To switch off:** press the combination switch to position **0**.

Position **2** changes to position **1** when the engine is stopped.

In position **1** or in the  position, the windscreen wipers stop automatically when the engine is stopped and the driver's door is opened.

**Vehicles with a rain sensor:** in position **AUTO** the windscreen wipers stop automatically when the engine is stopped.

The windscreen will no longer be wiped properly if the wiper blades are worn. This could prevent you from observing the traffic conditions.

### Intermittent wipe



**Vehicles with a rain sensor:** the appropriate wiping frequency is automatically set according to the intensity of the rain. With intermittent wiping you can also adjust the sensitivity of the rain sensor using control **①**. When the sensitivity is set to high, the windscreen wiper wipes more frequently.

- ▶ **To switch on:** start the engine (▷ page 121).
- ▶ Press the combination switch to the **AUTO** position.  
The windscreen wipers sweep once.

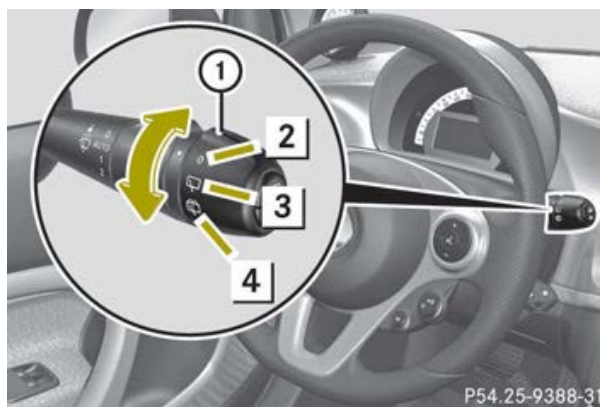
### Switching the rear window wiper on/off



Combination switch

- ① Control
- 2 **0** Rear window wiper off
- 3  Rear window wiper on
- 4  Wiping with washer fluid

- ▶ Turn the key to position **2** in the ignition lock or start the engine (▷ page 121).
- ▶ Turn control **①** on the combination switch to the corresponding position.

### Replacing the wiper blades

#### Important safety notes

#### WARNING

If the windscreen wipers begin to move while you are changing the wiper blades, you can be trapped by the wiper arm. There is a risk of injury.

Always switch off the windscreen wipers and ignition before changing the wiper blades.

- ❗ To avoid damaging the windscreen wiper blades, make sure that you touch only the wiper arm of the windscreen wiper.
- ❗ Never open the service cover/tailgate if a windscreen wiper arm has been folded away from the windscreen/rear window.

Never fold a windscreen wiper arm without a wiper blade back onto the windscreen/rear window.

Hold the windscreen wiper arm firmly when you change the wiper blade. If you release the windscreen wiper arm without a wiper blade and it falls onto the windscreen/rear window, the windscreen/rear window may be damaged by the force of the impact.

smart recommends that you have the wiper blades changed at a qualified specialist workshop.

### Replacing the windscreen wiper blades

#### Removing the wiper blades

- ▶ Turn the key to position **1** or **2** in the ignition lock (▷ page 121).
- ▶ Press the combination switch to the **5** position (▷ page 101).  
The wiper arms move slowly upwards.
- ▶ When the wiper arms are vertical in relation to the service cover, turn the key to position **0** and remove it from the ignition lock.
- ▶ Fold the wiper arm away from the windscreen.

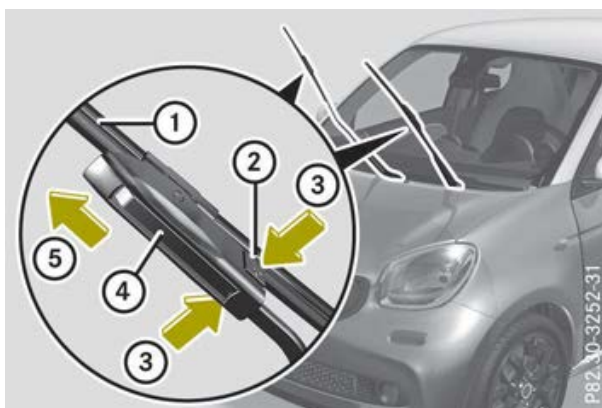

- ▶ Press the two release clips (2) on mounting (4) in the direction of arrow (3) and pull away from the wiper arm.
- ▶ Slide wiper blade (1) in the direction of arrow (5) until the wiper blade securing hook is revealed.
- ▶ Remove wiper blade (1).

#### Fitting the wiper blades

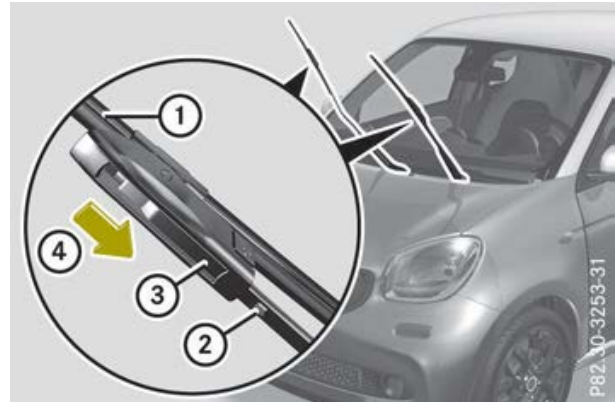

- ▶ Slide new wiper blade (1) in the direction of arrow (4) onto mounting (3) of wiper arm (2).  
Wiper blade (1) engages.
- ▶ Make sure that wiper blade (1) is seated correctly.
- ▶ Fold wiper arm (2) back onto the windscreen.

### Replacing the rear window wiper blade

#### Removing the wiper blades

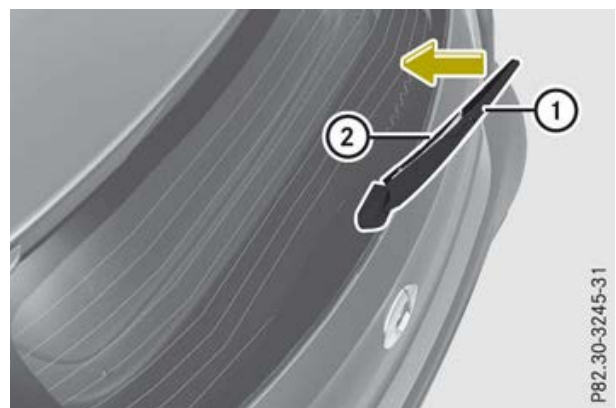

- ▶ Remove the key from the ignition lock.
- ▶ Fold wiper arm (1) away from the rear window until it engages.

- ▶ Turn wiper blade ② in the direction of the arrow until it is released from the retainer on the wiper arm.
- ▶ Remove wiper blade ②.

#### **Fitting a wiper blade**

- ▶ Push new wiper blade ② onto wiper arm ① until you feel it engage.
- ▶ Turn wiper blade ② parallel to wiper arm ①.
- ▶ Make sure that wiper blade ② is seated correctly.
- ▶ Fold wiper arm ① back onto the rear window.

### Problems with the windscreen wipers

Problem	Possible causes/consequences and ► Solutions
<p>The windscreen wipers do not stop or continue wiping with the same speed regardless of a change in position.</p>	<p>The combination switch or rain sensor is malfunctioning.</p> <ul style="list-style-type: none"> <li>► Stop the vehicle, paying attention to traffic conditions as you do so and switch off the engine.</li> <li>► For safety reasons, you should remove the key from the ignition lock and open the driver's door.</li> <li>► Turn the key to position <b>1</b> in the ignition lock. Then try to start the engine again.</li> <li>► Have the windscreen wipers checked at a qualified specialist workshop.</li> </ul>
<p>The windscreen wipers are jammed.</p>	<p>Leaves or snow, for example, may be obstructing the windscreen wiper movement. The wiper motor has been deactivated.</p> <ul style="list-style-type: none"> <li>► Stop the vehicle, paying attention to traffic conditions as you do so and switch off the engine.</li> <li>► For safety reasons, you should remove the key from the ignition lock.</li> <li>► Remove the cause of the obstruction.</li> <li>► Switch the windscreen wipers on again after 30 seconds.</li> </ul>
<p>The windscreen wiper has stopped in the middle of the windscreen.</p>	<p>The windscreen wiper drive has stopped for safety reasons.</p> <ul style="list-style-type: none"> <li>► Have the windscreen wipers checked at a qualified specialist workshop.</li> </ul>
<p>The windscreen wipers fail completely.</p>	<p>The windscreen wiper drive is malfunctioning.</p> <ul style="list-style-type: none"> <li>► Select another wiper speed on the combination switch.</li> <li>► Have the windscreen wipers checked at a qualified specialist workshop.</li> </ul>



Useful information .....	108
Overview of climate control systems ....	108
Operating the climate control system ...	111
Adjusting the air vents .....	117

### Useful information

- i** This Owner's Manual describes all models, series and optional equipment for your vehicle that were available at the time of going to press. Country-specific differences are possible. Note that your vehicle may not be fitted with all features described. This is also the case for systems and functions relevant to safety.
- i** Read the information on qualified specialist workshops: (▷ page 21).

- i** The integrated filter can filter out most particles of dust and as well as pollen. With automatic climate control, odours carried in the air are also reduced. A clogged filter reduces the amount of air supplied to the vehicle interior. For this reason, you should always observe the interval for replacing the filter, which is specified in the Service Booklet. As it depends on environmental conditions, e.g. heavy air pollution, the interval may be shorter than stated in the Service Booklet.

## Overview of climate control systems

### General notes

Observe the settings recommended on the following pages. The windows could otherwise mist up.

To prevent the windows from misting up:

- switch off climate control only briefly
- switch on air-recirculation mode only briefly
- **air-conditioning system/automatic climate control:** switch on the cooling with air dehumidification function
- switch on the "demist windscreen" function briefly, if required

The heating, air-conditioning system and the automatic climate control regulate the temperature and humidity in the vehicle interior. They also filter undesirable substances out of the air.

The heating, air-conditioning system and automatic climate control can only be operated when the engine is running. They only function optimally when the side windows are closed.

- i** Ventilate the vehicle for a brief period during warm weather. This will speed up the cooling process and the desired interior temperature will be reached more quickly.

### Heating/air-conditioning system control panel

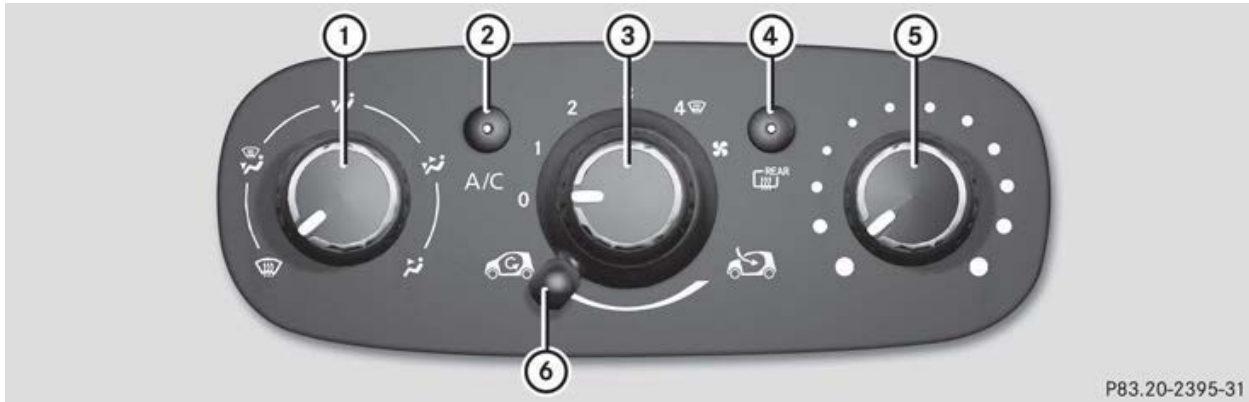



P83.20-2395-31

- ① Sets the air distribution (▷ page 113)
- ② Switches cooling with air dehumidification on/off (air-conditioning system only) (▷ page 112)
- ③ Sets the airflow (▷ page 114)
- ④ Switches the rear window heating on/off (▷ page 115)  
Switches the exterior mirror heating on/off (for vehicles with heated exterior mirrors only)
- ⑤ Sets the temperature (▷ page 113)
- ⑥ Switches the air-recirculation mode on/off (▷ page 117)

#### Notes on using the heating/air-conditioning system

##### Heating/air-conditioning system

Below, you can find a number of tips and recommendations for optimum use of the heating/air-conditioning system.

- Switch on climate control by turning control ③ clockwise to the desired position (except position 0).
- Change the temperature settings in small increments only.  
To increase and reduce the temperature turn control ⑤ clockwise or anti-clockwise.
- **Recommendation for demisting front windows at low exterior temperatures or in rain:** switch air distribution control ① to the  position. Deactivate air-recirculation mode . Turn air-flow control ③ to position 4. Turn tem-

perature control ⑤ clockwise as far as possible.

Only use the "Windscreen demisting" function briefly until the windscreen is clear again.

- **Recommendation for rapid cooling or heating of the vehicle interior:** briefly set air flow control ③ to 3 or 4.
- **Recommendation for a constant interior temperature:** set air flow control ③ to position 1 or 2.
- Only use the air-recirculation mode briefly, e.g. if there are unpleasant outside odours or when in a tunnel. The windows could otherwise mist up as no fresh air is drawn into the vehicle in air-recirculation mode.

##### Automatic start/stop system

During automatic engine switch-off, the climate control only operates at a reduced capacity. If you require the full climate

control output, you can switch off the automatic start/stop system by pressing the automatic start/stop system button (▷ page 125).



>> Climate control.

### Automatic climate control panel



- ① Increases the airflow (▷ page 114)
- ② Demists the windscreen (▷ page 114)
- ③ Switches the air-recirculation mode on/off (▷ page 117)
- ④ Switches the rear window heating on/off (▷ page 115)  
Switches the exterior mirror heating on/off (for vehicles with heated exterior mirrors only)
- ⑤ Sets the air distribution (▷ page 113)
- ⑥ Sets climate control to automatic mode (▷ page 113)
- ⑦ Switches the climate control on/off (▷ page 111)
- ⑧ Switches cooling with air dehumidification on/off (▷ page 112)
- ⑨ Reduces the airflow (▷ page 114)
- ⑩ Sets the temperature (▷ page 113)

### Optimum use of automatic climate control

#### Automatic climate control

Below, you can find a number of notes and recommendations to help you use climate control optimally.

- Activate climate control primarily using the **AUTO** button.
- Set the temperature to 22 °C.
- Only use the "Windscreen demisting" function briefly until the windscreen is clear again.
- Only use the air-recirculation mode briefly, e.g. if there are unpleasant outside odours or when in a tunnel. The windows could otherwise mist up as no fresh air is drawn into the vehicle in air-recirculation mode.

### Automatic start/stop system

During automatic engine switch-off, the climate control only operates at a reduced capacity. If you require the full climate control output, you can switch off the automatic start/stop system by pressing the automatic start/stop system button (▷ page 125).

### Operating the climate control system

#### Switching the climate control on/off

#### General notes

When the climate control is switched off, the air supply and air circulation are also switched off. The windows could mist up.

Therefore, only switch off climate control briefly.

### Switching the sound on/off



#### Heating/air-conditioning system

- ▶ Start the engine (▷ page 121).
- ▶ **To switch on:** turn airflow control ③ clockwise to the desired position (except position 0) (▷ page 109).
- ▶ **To switch off:** turn airflow control ③ anti-clockwise to position 0 (▷ page 109).

#### Automatic climate control

- ▶ Turn the key to position 1 or 2 in the ignition lock or start the engine (▷ page 121).
- ▶ **To switch on:** press the **AUTO** button. The indicator lamp under the **AUTO** button lights up.

or

- ▶ Press the  button.
- or
- ▶ Press the  button.
- ▶ **To switch off:** press the **OFF** button. The indicator lamp under the **OFF** button lights up.

or

- ▶ Press the  button repeatedly until all the indicator lamps go out.

### Switching cooling with air dehumidification on/off

#### General notes

The "Cooling with air-dehumidification" function is only available with the air-conditioning system or automatic climate control.

If you deactivate the "Cooling with air-dehumidification" function, the air inside the vehicle will not be cooled. The air inside the vehicle will also not be

dehumidified. The windows can mist up more quickly. Therefore, only switch off cooling with air dehumidification for a short period.

The cooling with air dehumidification function is only available when the engine is running. The air inside the vehicle is cooled and dehumidified according to the temperature selected.

The "Cooling with air-dehumidification" function does not operate at low outside temperatures.

Condensation may drip from the underside of the vehicle when cooling mode is active. This is normal and not a sign that there is a malfunction.

### Switching the sound on/off

#### Air-conditioning system

- ▶ Start the engine (▷ page 121).
- ▶ Set airflow control ③ clockwise to position 1 or higher (▷ page 114).
- ▶ **To switch on:** press the **A/C** button. The indicator lamp in the **A/C** button lights up.
- ▶ **To switch on:** press the **A/C** button. The indicator lamp in the **A/C** button goes out.

#### Automatic climate control

- ▶ Start the engine (▷ page 121).
- ▶ **To switch on:** press buttons  and **A/C**. The indicator lamp under the **A/C** button lights up.
- ▶ **To switch off:** press the **A/C** button. The indicator lamp under the **A/C** button goes out.



## Setting climate control to automatic mode

### General notes

This function is only available with automatic climate control.

In automatic mode, the set temperature is maintained automatically at a constant level. The system automatically regulates the temperature of the dispensed air, the airflow and the air distribution.

### Setting automatic mode

- ▶ Turn the key to position **1** or **2** in the ignition lock or start the engine (▷ page 121).
- ▶ **To switch on:** press the **AUTO** button. The indicator lamp under the **AUTO** button lights up.
- ▶ **To switch to manual mode:** press the  or  button.

or

- ▶ Press the ,  or  button.

or

- ▶ Press the  button. The indicator lamp under the **AUTO** button goes out.

- i** If you adjust one of the functions by hand, the indicator lamp under the **AUTO** button goes out. All other functions continue to be regulated automatically.



## Setting the temperature

### Heating/air-conditioning system

- ▶ Start the engine (▷ page 121).
- ▶ **To increase or reduce:** turn temperature control  clockwise or anti-clockwise (▷ page 109).

Change the temperature settings in small increments only.

## Automatic climate control





- ▶ Start the engine (▷ page 121).
- ▶ **To increase or reduce:** push temperature slider  to the right or left (▷ page 111). For the maximum or minimum temperature, push slider  completely to the right or left (▷ page 111).

Only change the temperature setting in small increments. Start at 22 °C.

## Setting the air distribution

### Air distribution settings



#### Heating/air-conditioning system

-  Directs the airflow through the demister vents
-  Directs the airflow through the footwell and demister vents
-  Directs the airflow through the footwell air vents
-  Directs the airflow through the centre, side and footwell vents
-  Directs the airflow through the centre and side air vents

- i** **Recommendation for air distribution in winter:** set the  setting.

**Recommendation for air distribution in summer:** set the  setting.

#### Automatic climate control

-  Directs the airflow through the demister vents
-  Directs the airflow through the centre and side air vents
-  Directs the airflow through the footwell air vents

- i** You can also activate several of the air distribution settings simultaneously. In order to do this, press several of the air distribution buttons. The air is then routed through different air vents.

**Recommendation for air distribution in winter:** set the  and  settings.

**Recommendation for air distribution in summer:** set the  setting.



## Setting the air distribution

### Heating/air-conditioning system

- ▶ Start the engine (▷ page 121).
- ▶ Turn air distribution control ① clockwise or anti-clockwise until the indicator is at the desired position (▷ page 109).

**i** You can turn the indicator to a position between two symbols. There are intermediate levels between the air distribution positions.

### Automatic climate control





- ▶ Start the engine (▷ page 121).
- ▶ Press one or more of the ,  or  buttons. The indicator lamp next to the respective button selected lights up.

## Setting the airflow

### Heating/air-conditioning system

- ▶ Start the engine (▷ page 121).
- ▶ **To increase or reduce:** turn airflow control ③ clockwise or anti-clockwise to one of the four detents (▷ page 109).

### Automatic climate control

- ▶ Start the engine (▷ page 121).
- ▶ **To increase:** press the  button. With each press of the  button, one indicator lamp next to the airflow buttons lights up.
- ▶ **To decrease:** press the  button. With each press of the  button, one indicator lamp next to the airflow buttons goes out.

## Demisting the windscreen



### General notes

You can use this function to demist the windscreen or to demist the inside of the windscreen and the side windows.



**i** You should only select the "Windscreen demisting" function until the windscreen is clear again.

### Switching the sound on/off

### Heating/air-conditioning system

- ▶ Start the engine (▷ page 121).
- ▶ **To switch on:** turn air distribution control ① to the  position (▷ page 109).
- ▶ Turn airflow control ③ to position 4 (▷ page 109).
- ▶ Turn temperature control ⑤ clockwise as far as possible (▷ page 109).
- ▶ Slide air distribution control ⑥ to the right (▷ page 109).
- ▶ **To switch off:** turn air distribution control ① to the desired position (apart from the  position) (▷ page 109).
- ▶ Turn air distribution control ③ and temperature control ⑤ anti-clockwise to the desired position (▷ page 109).

### Automatic climate control

- ▶ Turn the key to position 1 or 2 in the ignition lock or start the engine (▷ page 121).
- ▶ **To switch on:** press the  button. The indicator lamp above the  button lights up. Automatic mode **AUTO** is deactivated. The  "Demist windscreen" function switches the automatic climate control to the following functions:

- cooling with air dehumidification on
- high airflow

- air distribution to the windscreen and front side windows
- air-recirculation mode off

▶ **To switch off:** press the  button.



or

▶ Press the  button.

or

▶ Press the  button.

or

▶ Press the ,  or  button.

The indicator lamp above the  button goes out.

The rear window heating is turned off.

### Demisting the windows



#### Windows misted up on the inside

##### Heating/air-conditioning system

- ▶ **Air-conditioning system:** activate the  "Cooling with air dehumidification" function.
- ▶ If the windows continue to mist up, activate the "Windscreen demisting" function (▷ page 114).

 You should only select this setting until the windscreen is clear again.

##### Automatic climate control

- ▶ Activate the  cooling with air dehumidification function.
- ▶ Activate automatic mode .
- ▶ If the windows continue to mist up, activate the "Windscreen demisting" function .

 You should only select this setting until the windscreen is clear again.

#### Windows misted up on the outside

##### Heating/air-conditioning system

- ▶ Activate the windscreen wipers.
- ▶ Set the air distribution to .

 You should only select this setting until the windscreen is clear again.

##### Automatic climate control

- ▶ Activate the windscreen wipers.
- ▶ Set the air distribution to .

 You should only select this setting until the windscreen is clear again.

### Rear window heating

#### General notes

The rear window heating has a high current draw. You should therefore switch it off as soon as the window is clear.

The rear window heating can only be switched on and off when the engine is running.





The rear window heating automatically switches off after approximately 10 minutes.

#### Vehicles with heated exterior mirrors:





when you switch on the rear window heating, the exterior mirrors are also heated. When the rear window heating is switched off, the exterior mirror heating will also turn off.

#### Switching the sound on/off

##### Heating/air-conditioning system

- ▶ Start the engine (▷ page 121).
- ▶ **To switch on:** press the  button. The indicator lamp in the  button lights up.
- ▶ **To switch off:** press the  button. The indicator lamp in the  button goes out.

**Automatic climate control**

- ▶ Start the engine (▷ page 121).
- ▶ **To switch on:** press the  button.  
The indicator lamp above the  button lights up.
- ▶ **To switch off:** press the  button.  
The indicator lamp above the  button goes out.

## Problems with the rear window heating

Problem	Possible causes/consequences and ► Solutions
The rear window heating has switched off prematurely or cannot be activated.	<p>The battery has not been sufficiently charged.</p> <p>► Switch off any consumers that are not required, e.g. reading lamps, interior lighting or the seat heating.</p> <p>When the battery is sufficiently charged, the rear window heating can be activated again.</p>

### Switching the air-recirculation mode on/off

#### General notes

You can deactivate the flow of fresh air if you are in a tunnel or if unpleasant odours are entering the vehicle from outside. The air already inside the vehicle will then be recirculated.



If you switch on air-recirculation mode, the windows can mist up more quickly, in particular at low temperatures. Only use air-recirculation mode briefly to prevent the windows misting up.

#### Switching the sound on/off

##### Heating/air-conditioning system

- Start the engine (► page 121).
- **To switch on:** slide control ⑥ to the left (► page 109).
- **To switch off:** slide control ⑥ to the right (► page 109).

##### Automatic climate control

- Start the engine (► page 121).
- **To switch on:** press the  button. The indicator lamp above the  button lights up.
- **To switch off:** press the  button.

or

- Press the  button.

or

- Press the **AUTO** button.

The indicator lamp above the  button goes out.

## Adjusting the air vents

### Important safety notes

#### WARNING

Very hot or very cold air can flow from the air vents. This could result in burns or frostbite in the immediate vicinity of the air vents. There is a risk of injury.

Make sure that all vehicle occupants always maintain a sufficient distance to the air outlets. If necessary, redirect the airflow to another area of the vehicle interior.

#### WARNING

If you pour cleaning fluid or disinfectant into the vehicle's ventilation system, it may ignite. There is a risk of fire.

Never spray these or other agents into the ventilation system. Always have work on the ventilation system carried out at a qualified specialist workshop.

In order to ensure the direct flow of fresh air through the air vents into the vehicle interior, please observe the following notes:

- keep the air inlet between the service cover and the windscreen free of blockages, such as ice, snow or leaves.
  - never cover the vents or ventilation grilles in the vehicle interior.
- i** For optimum climate control in the vehicle, open the air vents fully.

>> Climate control.

### Setting the centre air vents

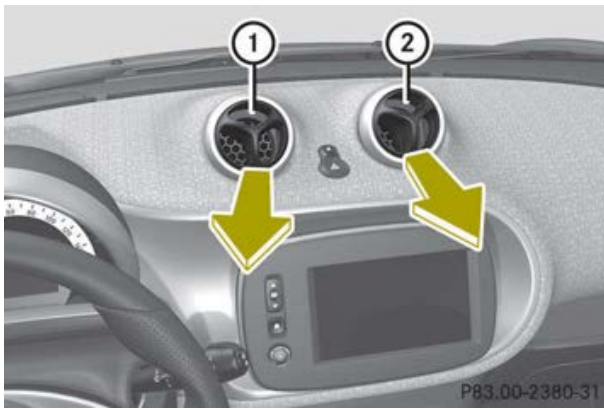

- ▶ **To adjust the air direction:** hold centre air vent ① or ② in the middle and turn and/or tilt it in the desired direction up, down, to the left or to the right.
- ▶ **To close the centre air vent:** hold centre air vent ① or ② in the middle and tilt inwards until the vent openings can no longer be seen.



- ▶ **To open the centre air vent:** hold centre air vent ① or ② in the middle and tilt outwards until the vent openings can be seen.

### Setting the side air vents

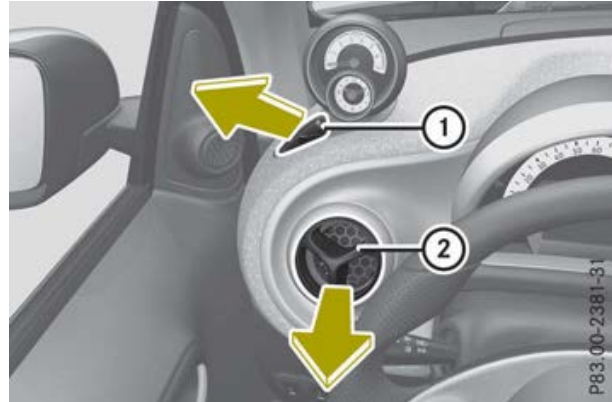

- ▶ **To adjust the air direction:** hold side air vent ② in the middle and turn and/or tilt in the desired direction up, down, to the left or to the right.
  - ▶ **To close the side air vent:** hold side air vent ② in the middle and tilt inwards until the vent openings can no longer be seen.
  - ▶ **To open the side air vent:** hold side air vent ② in the middle and tilt outwards until the vent openings can be seen.
- Demister vent ① cannot be adjusted.

Useful information .....	120
Running-in notes .....	120
Driving .....	120
Manual transmission .....	127
Automatic transmission .....	128
Refuelling .....	136
Parking .....	138
Driving tips .....	140
Driving systems .....	145

### Useful information

- i** This Owner's Manual describes all models, series and optional equipment for your vehicle that were available at the time of going to press. Country-specific differences are possible. Note that your vehicle may not be fitted with all features described. This is also the case for systems and functions relevant to safety.
- i** Read the information on qualified specialist workshops: (▷ page 21).

### Running-in notes

#### Important safety notes

In certain driving and driving safety systems, the sensors adjust automatically while a certain distance is being driven after the vehicle has been delivered or after repairs. Full system effectiveness is not reached until the end of this teach-in procedure.

New or replaced brake pads/linings and discs only reach their optimum braking effect after several hundred kilometres of driving. Compensate for the reduced braking effect by applying greater force to the brake pedal.

### The first 1500 km

If you treat the engine with sufficient care from the very start, you will be rewarded with excellent performance for the remainder of the engine's life.

- Drive at varying vehicle speeds and engine speeds for the first 1500 km.
- Avoid overstraining the vehicle during this period, e.g. driving at full throttle.
- Change gear in good time, before the rev counter needle is  $\frac{2}{3}$  of the way to the red area of the rev counter.

- Do not shift down a gear manually in order to brake.
- Vehicles with automatic transmission: if possible, do not depress the accelerator pedal beyond the pressure point (kickdown).
- Vehicles with automatic transmission: ideally drive in program **E** for the first 1500 km.

After 1500 km, you may gradually bring the vehicle up to full road and engine speeds. You should also observe these notes on running-in if the engine or parts of the drive train on your vehicle have been replaced. Observe the maximum permissible speed.

### Driving

#### Important safety notes

#### WARNING

Objects in the driver's footwell may restrict the clearance around the pedals or block a depressed pedal. This jeopardises the operating and road safety of the vehicle. There is a risk of an accident.

Stow all objects securely in the vehicle so that they do not get into the driver's footwell. Always fit the floormats securely and as prescribed in order to ensure that there is always sufficient room for the pedals. Do not use loose floormats and do not place several floormats on top of one another.

#### WARNING

Unsuitable footwear can hinder correct usage of the pedals, e.g.:

- shoes with thick soles
- shoes with high heels
- slippers

There is a risk of an accident.

Wear suitable footwear to ensure correct usage of the pedals.

**⚠ WARNING**

If you switch off the ignition while driving, safety-relevant functions are only available with limitations, or not at all. This could affect, for example, the power steering and the brake boosting effect. You will require considerably more effort to steer and brake. There is a risk of an accident.

Do not switch off the ignition while driving.

**⚠ WARNING**

If the parking brake has not been fully released when driving, the parking brake can:

- overheat and cause a fire
- lose its hold function.

There is a risk of fire and an accident. Release the parking brake fully before driving off.

**!** Do not warm up the engine when the vehicle is stationary. Drive off immediately. Avoid high engine speeds and driving at full throttle until the engine has reached its operating temperature. Only shift the automatic transmission to the desired drive position when the vehicle is stationary.

Where possible, avoid spinning the drive wheels when pulling away on slippery roads. You could otherwise damage the drive train.

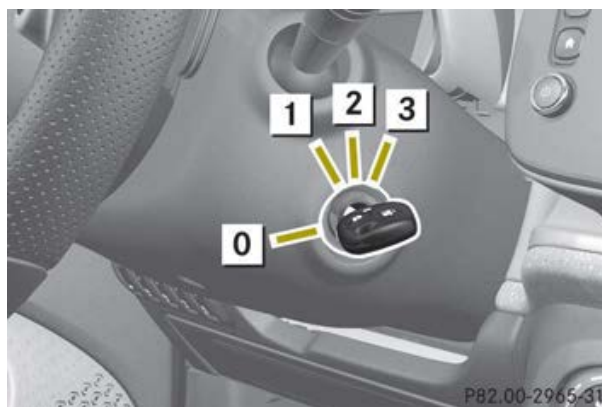
**Key positions**

- 0** To remove the key
- 1** Power supply for some consumers, such as the windscreen wipers
- 2** Ignition (power supply for all consumers) and drive position
- 3** To start the engine

The steering wheel is locked when the key is removed from the ignition lock.

**Starting the engine****Important safety notes****⚠ WARNING**

If children are left unsupervised in the vehicle, they could:

- open doors, thereby endangering other persons or road users
- get out and be struck by oncoming traffic
- operate vehicle equipment and become trapped, for example

In addition, the children could also set the vehicle in motion, for example, if they:

- release the parking brake
- shift the automatic transmission out of park position P or shift manual transmission into neutral
- start the engine

There is a risk of an accident and injury. When leaving the vehicle, always take the key with you and lock the vehicle. Never leave children and animals unattended in

the vehicle. Keep the keys out of the reach of children.

#### **WARNING**

Combustion engines emit poisonous exhaust gases such as carbon monoxide. Inhaling these exhaust gases leads to poisoning. There is a risk of fatal injury. Therefore never leave the engine running in enclosed spaces without sufficient ventilation.

#### **WARNING**

Flammable materials introduced through environmental influence or by animals can ignite if in contact with the exhaust system or parts of the engine that heat up. There is a risk of fire.

Carry out regular checks to make sure that there are no flammable foreign materials in the engine compartment or in the exhaust system.

 Do not depress the accelerator when starting the engine.

 The engine runs at a higher engine speed during a cold start so that the catalytic converter can reach operating temperature more quickly. The sound of the engine may change as a result.

### **Manual transmission**

- ▶ Depress the brake pedal and keep it depressed.
- ▶ Depress the clutch pedal fully.
- ▶ Engage neutral.

### **Automatic transmission**

- ▶ Shift the transmission to position **P** (▷ page 129).  
The transmission position display in the multifunction display shows **P** (▷ page 129).

 You can start the engine in transmission positions **P** and **N**.

In order to start the engine in transmission position **N** you must depress the brake pedal and keep it depressed.

### **Starting procedure**

- ▶ Turn the key to position **3** in the ignition lock (▷ page 121) and release it as soon as the engine is running.

### **Pulling away**

#### **General notes**

#### **WARNING**

Vehicles with automatic transmission:

If the engine speed is above the engine idling speed and you then engage transmission position **D** or **R**, the vehicle may accelerate suddenly. There is a risk of an accident.

When engaging transmission position **D** or **R**, always keep the brake pedal firmly depressed and do not depress the accelerator pedal at the same time.

 **Vehicles with manual transmission:**

change gear in good time and avoid spinning the wheels. You could otherwise damage the vehicle.

 Release the parking brake before driving off. The parking brake can otherwise overheat, malfunction and wear out quickly.

Accelerate gently when pulling away.

The vehicle locks centrally once you have pulled away.

You can open the doors from the inside at any time.

You can also deactivate the automatic locking feature (▷ page 73).

**Vehicles with automatic transmission:** you can only shift the transmission from position **P** to the desired transmission position if:

- the ignition is switched on
- you depress the brake pedal and keep it depressed and
- you press release button on the selector lever (▷ page 129).

Only then is the shift lock released.

**i Vehicles with automatic transmission:** transmission shifts take place at higher engine speeds after a cold start. This helps the catalytic converter to reach its operating temperature more quickly.

### Hill start assist

Hill start assist helps you when pulling away forwards or in reverse on an uphill gradient. It holds the vehicle for a short time after you have removed your foot from the brake pedal. This gives you enough time to move your foot from the brake pedal to the accelerator pedal and depress it before the vehicle begins to roll.

#### **WARNING**

After a while, hill start assist no longer holds the vehicle and it may roll away. There is a risk of an accident and injury. Therefore, quickly move your foot from the brake pedal to the accelerator pedal. Never leave the vehicle when it is held by hill start assist.

Hill start assist is not active if:

- you pull away on level ground
- you pull away in a forward gear on a downhill slope
- on vehicles with automatic transmission, the transmission is in position **N**
- the parking brake is engaged
- esp<sup>®</sup> is malfunctioning.

## Automatic start/stop system

### Introduction

The automatic start/stop system switches the engine off automatically if the vehicle is stopped under certain conditions.

When pulling away again, the engine starts automatically. The automatic start/stop system thereby helps you to reduce the fuel consumption and emissions of your vehicle.

### General notes

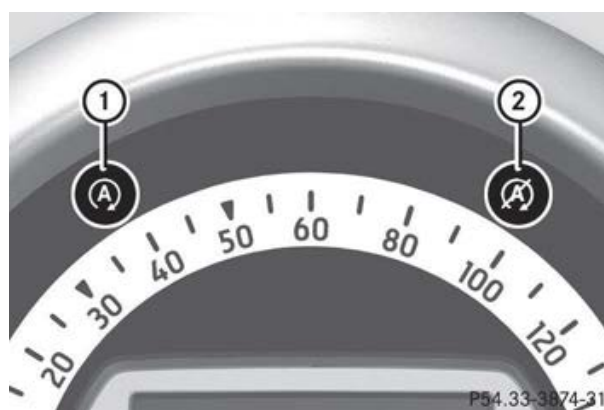

- ① Start/stop display (conditions are met)
- ② Start/stop display (conditions not met)

The automatic start/stop system is automatically activated when you start the engine with the key.

The indicator lamp in the automatic start/stop system button lights up if the automatic start/stop system has been deactivated manually (▷ page 125) or as the result of a malfunction.

## Automatic start/stop function

### General notes

If the automatic start/stop system automatically switches off the engine, the  symbol is shown in the instrument cluster. This is the case if, among other things:

- the indicator lamp in the automatic start/stop system button does not light up
- the outside temperature is within the range that is suitable for the system
- the engine is at normal operating temperature
- the set temperature for the vehicle interior has been reached
- the battery is sufficiently charged
- the system detects that the windscreen is not misted up when the air-conditioning system is switched on
- the tailgate is closed
- the driver's door is closed and the driver's seat belt is fastened

If not all conditions for automatic start/stop system are fulfilled, the  symbol is shown.

**i** All of the vehicle's systems except the climate control remain active when the engine is switched off automatically.

This is also the case if you exit the vehicle. If you wish to exit the vehicle, always turn off the ignition and secure the vehicle against rolling away.

**i** The  symbol flashes and a warning tone sounds if:

- the automatic start/stop system switches the engine off automatically, and
- you take off your seat belt, and
- you open the driver's door

**Vehicles with a colour display:** in addition, the **When exiting: remove key** warning message appears.

## Vehicles with manual transmission

The automatic start/stop system switches the engine off automatically if you stop the vehicle.

- ▶ Brake the vehicle.
- ▶ Engage neutral (▷ page 127).
- ▶ Release the clutch pedal.  
The engine is switched off automatically.

## Vehicles with automatic transmission

If the vehicle is stopped in transmission position **D** or **N**, the ECO start/stop function switches off the engine automatically.

**i** This is also the case if you have manually activated the switch.

## Automatic engine start

### General notes

The engine is started automatically if:

- you switch off the automatic start/stop system by pressing the automatic start/stop system button
- you open the tailgate
- the vehicle starts to roll
- the temperature in the vehicle interior deviates from the set range
- the system detects moisture on the windscreen when the air-conditioning system is switched on
- the battery's charge status is too low

## Vehicles with manual transmission

**!** Only engage gear when the clutch pedal is depressed.

The engine is started automatically if you depress the clutch pedal.

### Vehicles with automatic transmission

The engine is started automatically if you:

- release the brake pedal when in transmission position **D** or **N**
- release the brake pedal with manual transmission activated
- move the transmission out of position **P**

Shifting the transmission to position **P** does not start the engine.

### Switching the automatic start/stop system on and off



- ▶ **To deactivate:** press automatic start/stop system button ②.  
Indicator lamp ① lights up.
  - ▶ **To activate:** press automatic start/stop system button ②.  
Indicator lamp ① goes out.
- i** If indicator lamp ① is on, the automatic start/stop system has been deactivated manually or as the result of a malfunction. The engine will then not be switched off automatically when the vehicle stops.



**Problems with the engine**

Problem	Possible causes/consequences and ► Solutions
The engine does not start. The starter motor can be heard.	<ul style="list-style-type: none"> <li>• There is a malfunction in the engine electronics.</li> <li>• There is a malfunction in the fuel supply.</li> </ul> ► Switch off the engine before attempting to start the engine again (▷ page 139). ► Try to start the engine again (▷ page 121). Avoid excessively long and frequent attempts to start the engine, as this will drain the battery.  If the engine does not start after several attempts: ► Consult a qualified specialist workshop.
The engine does not start. The starter motor can be heard.  The fuel gauge indicates empty.	The fuel tank is empty. ► Refuel the vehicle.
The engine does not start. You cannot hear the starter motor.	The on-board voltage is too low because the battery is too weak or discharged. ► Jump-start the vehicle (▷ page 236).  If the engine does not start despite attempts to jump-start it: ► Consult a qualified specialist workshop.  The starter motor was exposed to a thermal load that was too high. ► Allow the starter motor to cool down for approximately two minutes. ► Try to start the engine again.  If the engine still does not start: ► Consult a qualified specialist workshop.
The engine is not running smoothly and is misfiring.	There is a malfunction in the engine electronics or in a mechanical component of the engine management system. ► Only depress the accelerator pedal slightly. Otherwise, non-combusted fuel may get into the catalytic converter and damage it. ► Have the cause rectified immediately at a qualified specialist workshop.

Problem	Possible causes/consequences and ► Solutions
<p>The coolant temperature exceeds 110 °C. The red coolant temperature warning lamp comes on while the engine is running. A warning tone also sounds.</p> <p><b>Vehicles with a colour display:</b> the <b>Stop Switch off engine</b> message appears.</p>	<p>The coolant level is too low. The coolant is too hot and the engine is no longer being cooled sufficiently.</p> <ul style="list-style-type: none"> <li>► Stop as soon as possible and allow the engine and the coolant to cool down.</li> <li>► Check the coolant level (► page 218). Observe the warning notes as you do so and top up the coolant if necessary.</li> </ul> <p>If the coolant level is correct, the engine radiator fan may be faulty. The coolant is too hot and the engine is no longer being cooled sufficiently.</p> <ul style="list-style-type: none"> <li>► If the coolant temperature is below 110 °C, you can continue driving to the nearest qualified specialist workshop.</li> <li>► Avoid heavy loads on the engine as you do so, e.g. driving in mountainous terrain and stop-start traffic.</li> </ul>

## Manual transmission

### Gear lever

! Only engage gear when the clutch pedal is depressed.

! If you shift to **5th** gear, you must ensure that the gear lever is firmly pushed to the right. Otherwise, you could shift unintentionally into **3rd** gear and damage the transmission.

If you shift down at too high a speed (transmission braking), this can cause the engine to overrev, leading to engine damage.

Do not use the clutch bite point to keep the vehicle stationary on uphill gradients. There is otherwise a risk of damaging the clutch.

! On long and steep downhill gradients, especially if the vehicle is laden, you must shift into gear **1**, **2** or **3** in good time. By doing so, you will make use of the braking effect of the engine. This relieves the load on the brake system and prevents the brakes from overheating and wearing too quickly.



- 1 - 5 Forward gears  
R Reverse gear

### Shifting to neutral



- ▶ Depress the clutch pedal fully.
- ▶ Move the gearshift lever to position ①.

### Engaging reverse gear

**!** Only shift into reverse gear **R** when the vehicle is stationary. Otherwise, you could damage the transmission.

All vehicles except for smart 66 kw Turbo

- ▶ Engage neutral (▷ page 127).
- ▶ Press the gear lever to the right and then pull it back.



smart 66 kw Turbo

- ▶ Engage neutral (▷ page 127).
- ▶ Pull collar ① upwards.
- ▶ Press the gear lever to the right and then pull it back.

**i** When reverse gear is selected, the automatic start/stop system is not available. The automatic start/stop system is not available until you drive faster than 10 km/h again.

Additional information about the automatic start/stop system (▷ page 123).

### Gearshift recommendation

The gearshift recommendations assist you in adopting an economical driving style.

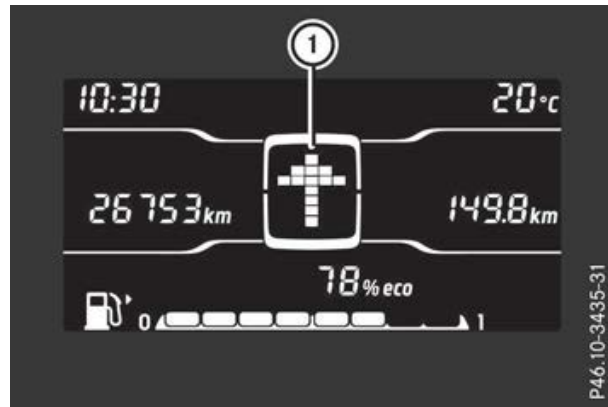

Vehicles with a monochrome display

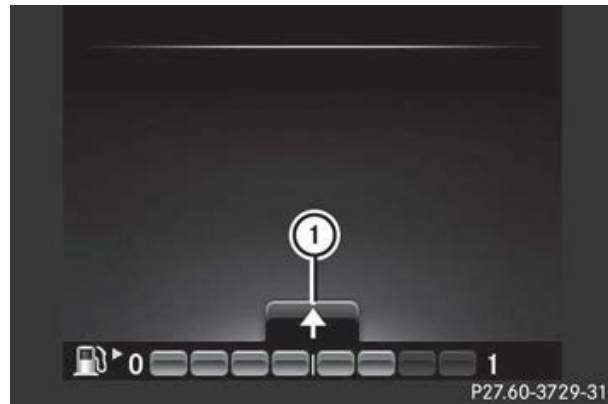

Vehicles with a colour display

- ▶ Shift one gear up or down according to gearshift recommendation ① when shown in the multifunction display of the instrument cluster.

Further information on the transmission display:

- Vehicles with a monochrome display (▷ page 157)
- Vehicles with a colour display (▷ page 159)

## Automatic transmission

### Important safety notes

#### **!** WARNING

If the engine speed is above the idling speed and you engage transmission position **D** or **R**, the vehicle could pull away suddenly. There is a risk of an accident.

When engaging transmission position **D** or **R**, always firmly depress the brake pedal and do not simultaneously accelerate.

### **WARNING**

The automatic transmission switches to neutral position **N** when you switch off the engine. The vehicle may roll away. There is a risk of an accident.

After switching off the engine, always switch to parking position **P**. Prevent the parked vehicle from rolling away by applying the parking brake.

### Selector lever

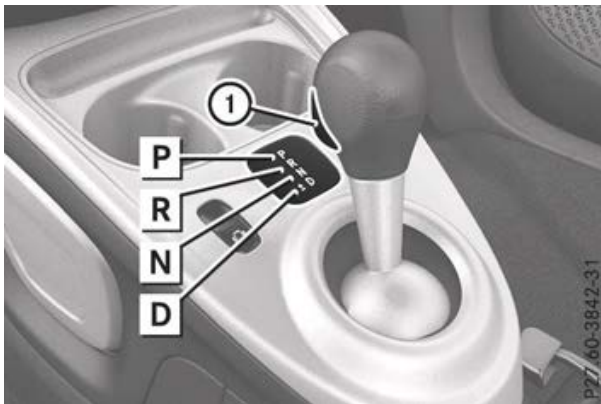

- P** Park position with parking lock
- R** Reverse gear
- N** Neutral
- D** Drive

► **To shift transmission position:** press release button ① and shift the gear lever to the desired transmission position.

When you shift the transmission from positions **N** or **P** to position **R**, the ignition must also be switched on.

**i** When you shift the transmission from positions **D** or **R** to position **N**, you do not need to press release button ①.

### Transmission position and drive program display

The current transmission position and drive program appear in the multifunction display.

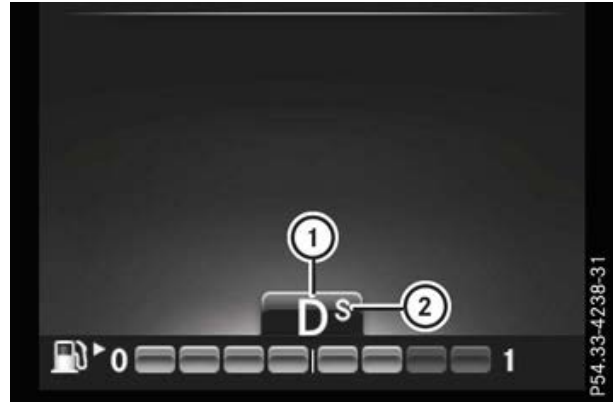

- ① Transmission position display
- ② Transmission mode display

## Transmission positions

**P**

### Park position

This prevents the vehicle from rolling away when stopped.

Only shift the transmission into position **P** (▷ page 129) when the vehicle is stationary. The parking lock should not be used as a brake when parking. Always apply the parking brake in addition to the parking lock in order to secure the vehicle.

In the event of a malfunction of the vehicle's electronics, the transmission may lock. Information on manually disconnecting the selector lever lock (▷ page 135).

Have the vehicle electronics checked immediately at a qualified specialist workshop.

**R**

### Reverse gear

Only shift the transmission into position **R** when the vehicle is stationary.

**N**

### Neutral

Do not shift the transmission to **N** while driving. Otherwise, the automatic transmission could be damaged.

No power is transmitted from the engine to the drive wheels.

Releasing the parking brake and brake pedal will allow you to move the vehicle freely, e.g. to push it or tow it away.

If esp® is deactivated or faulty: shift the transmission to position **N** if the vehicle is in danger of skidding, e.g. on icy roads.

**!** Rolling in neutral **N** can lead to damage to the transmission.

**D**

### Drive

The automatic transmission changes gear automatically. All forward gears are available.

## Driving tips

### Changing gear

The automatic transmission shifts to the individual gears automatically when it is in transmission position **D**. Gearshifting is determined by:

- the selected drive program
- the position of the accelerator pedal
- the road speed

### Accelerator pedal position

Your style of driving influences how the automatic transmission shifts gear:

- little throttle: early upshifts
- more throttle: late upshifts

## Kickdown

If you want maximum acceleration, use kickdown:

- ▶ Depress the accelerator pedal beyond the pressure point.  
The transmission shifts to a lower gear depending on the engine speed.
- ▶ Ease off the accelerator pedal once the desired speed is reached.  
The automatic transmission shifts back up.

## Rocking the vehicle free

Shifting back and forth between transmission positions **D** and **R** can help to free up the vehicle if it gets stuck in mud or snow.

- ▶ Shift the selector lever alternately between positions **D** and **R**.

The vehicle's engine management system limits the speed to a maximum of 9 km/h when shifting back and forth.

## Program selector button

The program selector button allows you to choose between drive programs with different driving characteristics.

The automatic transmission switches to drive program **E** every time the engine is started.



- ▶ Press program selector button ① to change the drive program.

The letter of the selected drive program appears in the multifunction display.

<b>E</b> Economy	Comfortable, economical driving
<b>S</b> Standard	Dynamic, agile driving

More information on drive programs (▷ page 131).

## Driving programs

### Drive program E (Economy)

Drive program **E** is characterised by the following:

- comfort-oriented engine settings
- optimal fuel consumption resulting from the automatic transmission shifting up sooner
- the automatic transmission shifting up sooner. This results in the vehicle being driven at lower engine speeds and the wheels being less likely to spin

### Drive program S (standard)

Drive program **S** is characterised by the following:

- the automatic transmission shifting up later.
- as a result of the later automatic transmission shift points, the fuel consumption possibly being higher.

## Manual gearshifting

### General notes

You can shift the gears manually using either the selector lever or the gearshift paddles. The transmission must be in position **D**.

If it is permissible, the automatic transmission shifts to the next highest or next lowest gear.

To use manual gearshifting, you have two possibilities:

- long-term setting
- short-term setting (vehicles with Sports package)

If you activate the manual gearshift setting, the currently selected gear is shown in the multifunction display instead of **D**.

### Long-term setting



- ▶ **To activate:** shift the selector lever to **D**.
- ▶ Push the selector lever to the left.



- ▶ **To deactivate:** push the selector lever to the right.

### Short-term setting (vehicles with Sports package)



- ▶ **To activate:** shift the selector lever to **D**.
- ▶ Pull gearshift paddle ① or ②.

The short-term setting remains active for a certain length of time. Under certain conditions this minimum time is increased, e.g. in the case of lateral acceleration, during an overrun phase or while driving on steep terrain.

- ▶ **To deactivate:** pull and hold gearshift paddle ②.

or

- ▶ Change the transmission position with the selector lever.

or

- ▶ Change the drive program with the program selector button.

### Shifting with the selector lever



- **To shift up:** push the selector lever in the  direction.

The automatic transmission shifts up to the next gear.

The automatic transmission automatically shifts up in order to prevent damage to the engine:

- when the maximum engine speed of the currently engaged gear has been reached and
  - you depress the accelerator pedal.
- **To shift down:** pull the selector lever in the  direction.

The automatic transmission shifts down to the next gear.

Downshifting occurs automatically while coasting.

If the engine exceeds the maximum engine speed when shifting down, the automatic transmission protects against engine damage by not shifting down.

### Shifting with gearshift paddles (vehicles with Sports package)



- **To shift up:** pull gearshift paddle ②. The automatic transmission shifts up to the next gear.

The automatic transmission automatically shifts up in order to prevent damage to the engine:

- when the maximum engine speed of the currently engaged gear has been reached and
  - you depress the accelerator pedal.
- **To shift down:** pull gearshift paddle ①. The automatic transmission shifts down to the next gear.

Downshifting occurs automatically while coasting.

If the engine exceeds the maximum engine speed when shifting down, the automatic transmission protects against engine damage by not shifting down.

### Gearshift recommendation

The gearshift recommendations assist you in adopting an economical driving style.

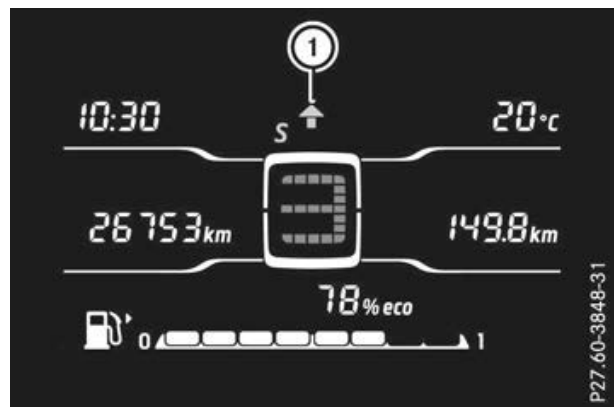

Vehicles with a monochrome display



Vehicles with a colour display

- ▶ Shift one gear up or down according to gearshift recommendation ① when shown in the multifunction display of the instrument cluster.

Further information on the transmission display:

- Vehicles with a monochrome display (▷ page 157)
- Vehicles with a colour display (▷ page 159)

### Kickdown

---

If you want maximum acceleration, you can also change the kickdown to be manually switched on:

- ▶ Depress the accelerator pedal beyond the pressure point.  
The transmission shifts to a lower gear depending on the engine speed.
  - ▶ Shift back up once the desired speed is reached.
- i** If you apply full throttle, the automatic transmission shifts up to the next gear when the maximum engine speed is reached. This prevents the engine from overrevving.

## Problems with the transmission

Problem	Possible causes/consequences and ► Solutions
The transmission has problems shifting gear.	The transmission is losing oil. ► Have the transmission checked at a qualified specialist workshop immediately.
The acceleration ability is deteriorating. The transmission no longer shifts into all of the gears. Reverse gear can no longer be engaged.	The transmission is in emergency mode. ► Stop. ► Shift the transmission to position <b>P</b> . ► Switch off the engine. ► Wait at least ten seconds before restarting the engine. ► Shift the transmission to position <b>D</b> . ► Have the transmission checked at a qualified specialist workshop immediately.

## Manually releasing the selector lever lock

You can manually release the selector level lock in the event of an electrical malfunction. This is the case, for example, when you want to release the parking brake while towing away the vehicle and then apply it again.

**!** Do not use any sharp-edged objects to prise out the cover from the centre console. Otherwise, the cover or the centre console could be damaged.



- Apply the parking brake.
- Prise out cover ① at lower edge ② with a flat, blunt object (e.g. a screwdriver wrapped in cloth).
- Pull cover ① in the direction of the arrow.

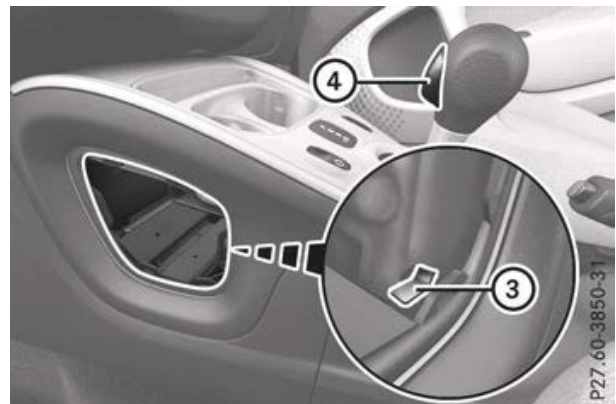

- Pull yellow release ③ behind the trim up and simultaneously press release button ④ on the selector lever.
- Shift the selector lever to **N** or **P**.

## Refuelling

### Important safety notes

#### WARNING

Fuel is highly flammable. If you handle fuel incorrectly, there is a risk of fire and explosion.

You must avoid fire, naked flames, creating sparks and smoking. Switch off the engine and, if applicable, the auxiliary heating before refuelling.

#### WARNING

Fuels are poisonous and hazardous to health. There is a danger of injury.

Do not swallow fuel or let it come into contact with skin, eyes or clothing. Do not inhale fuel vapours. Keep fuels out of the reach of children.

If you or others come into contact with fuel, observe the following:

- Wash the fuel off any affected areas of skin with water and soap immediately.
- If you get fuel in your eyes, rinse them thoroughly with clean water immediately. Seek immediate medical attention.
- If fuel is swallowed, seek immediate medical attention. Do not induce vomiting.
- Change any clothing that has come into contact with fuel immediately.

#### WARNING

Electrostatic charge can cause sparks and thereby ignite fuel vapours. There is a risk of fire and explosion.

Always touch the vehicle body before opening the fuel filler flap or touching the fuel pump nozzle. This discharges any electrostatic charge that may have built up.

Do not get into the vehicle again during the refuelling process. Otherwise, electrostatic charge could build up again.

 Do not use diesel to refuel vehicles with a petrol engine. Do not switch on the ignition if you accidentally refuel with the wrong fuel. Otherwise, the fuel will enter the fuel system. Even small amounts of the wrong fuel can result in damage to the fuel system and the engine. Notify a qualified specialist workshop and have the fuel tank and fuel lines drained completely.

 Overfilling the fuel tank could damage the fuel system.

 Take care not to spill any fuel on painted surfaces. You could otherwise damage the paintwork.

 Use a filter when adding fuel from a fuel can. The fuel lines and/or the fuel injection system could otherwise be blocked by particles from the fuel can.

If you overfill the fuel tank, some fuel may spray out when you remove the fuel pump nozzle.

For further information on fuel and fuel quality (▷ page 269).

## Refuelling

### General notes

The fuel filler flap is unlocked or locked automatically when you lock or unlock the vehicle with the key.

The position of the fuel filler cap is displayed  in the instrument cluster. The arrow next to the filling pump indicates the side of the vehicle.

## Opening the fuel filler flap

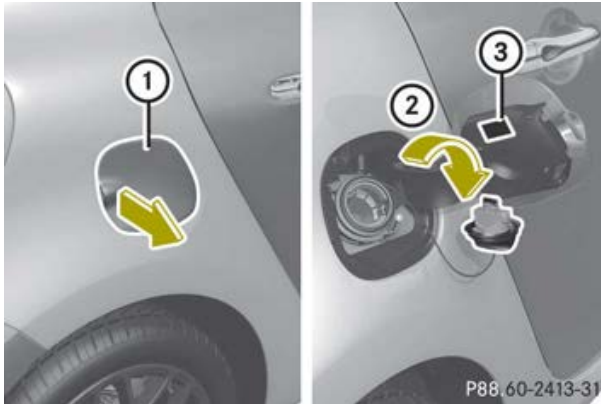

- ① To open the fuel filler flap
- ② To attach the fuel filler cap
- ③ Fuel type instruction label

- ▶ Switch off the engine.
- ▶ Remove the key from the ignition lock.
- ▶ Open the fuel filler flap in the direction of arrow ①.
- ▶ Turn the fuel filler cap anti-clockwise and remove it.
- ▶ Hang the fuel filler cap on the hook on the inside of the fuel filler flap.
- ▶ Completely insert the filler neck of the fuel pump nozzle into the tank, hook in place and refuel.
- ▶ Only fill the tank until the pump nozzle switches off.
- ⓘ Do not add any more fuel after the pump stops filling for the first time. Otherwise, fuel may leak out.

## Closing the fuel filler flap

- ▶ Replace the fuel filler cap on the filler neck and turn it clockwise.
- ▶ Close the fuel filler flap.
- ⓘ Close the fuel filler flap before locking the vehicle.



**Problems with the fuel and fuel tank**

Problem	Possible causes/consequences and ► Solutions
Fuel is leaking from the vehicle.	<p>The fuel line or the fuel tank is faulty.</p> <p> <b>WARNING</b></p> <p>There is a risk of fire or explosion.</p> <ul style="list-style-type: none"> <li>► Turn the key to position <b>0</b> in the ignition lock and remove it immediately (▷ page 121).</li> <li>► Do not restart the engine under any circumstances.</li> <li>► Consult a qualified specialist workshop.</li> </ul>
The fuel filler flap cannot be opened.	<p>The fuel filler flap is not unlocked.</p> <ul style="list-style-type: none"> <li>► Unlock the vehicle (▷ page 69).</li> </ul>
	<p>The key battery is discharged or nearly discharged.</p> <ul style="list-style-type: none"> <li>► Unlock the vehicle using the key element in the emergency lock (▷ page 74).</li> </ul>
	<p>The fuel filler flap is unlocked, but the opening mechanism is jammed.</p> <ul style="list-style-type: none"> <li>► Consult a qualified specialist workshop.</li> </ul>

**Parking**
**Important safety notes**
 **WARNING**

Flammable material such as leaves, grass or twigs may ignite if they come into contact with hot parts of the exhaust system or exhaust gas flow. There is a risk of fire.

Park the vehicle so that no flammable material can come into contact with hot vehicle components. In particular, do not park on dry grassland or harvested grain fields.

 **WARNING**

If you leave children unattended in the vehicle, they may be able to set the vehicle in motion if, for example, they:

- release the parking brake
- shift the automatic transmission out of park position **P** or shift manual transmission into neutral
- start the engine

In addition, they may operate vehicle equipment and become trapped. There is a risk of an accident and injury.

When leaving the vehicle, always take the key with you and lock the vehicle. Never leave children unattended in the vehicle.

 Always secure the vehicle correctly against rolling away. Otherwise, the vehicle or its drivetrain could be damaged.

To ensure that the vehicle is secured against rolling away unintentionally:

- the parking brake must be applied.
- a gear must be engaged on vehicles with manual transmission.
- the selector lever must be in position **P** on vehicles with automatic transmission.
- the key must be removed from the ignition lock.
- on uphill or downhill gradients, the front wheels must be turned towards the kerb.

### Switching off the engine

#### Important safety notes

##### **WARNING**

The automatic transmission switches to neutral position **N** when you switch off the engine. The vehicle may roll away. There is a risk of an accident.

After switching off the engine, always switch to parking position **P**. Prevent the parked vehicle from rolling away by applying the parking brake.

#### Vehicles with manual transmission

- ▶ Select a gear.
- ▶ Turn the key to position **0** in the ignition lock and remove it.  
The immobiliser is activated.
- ▶ Apply the parking brake.

#### Vehicles with automatic transmission

- ▶ Apply the parking brake.
- ▶ Shift the transmission to position **P**.
- ▶ Turn the key to position **0** in the ignition lock and remove it.  
The immobiliser is activated.

### Parking brake

#### General notes

##### **WARNING**

If you must brake the vehicle with the parking brake, the braking distance is considerably longer and the wheels could lock. This increases the risk of skidding and an accident.

Only use the parking brake to brake the vehicle when the service brake is faulty. Do not apply the parking brake too firmly. If the wheels lock, release the parking brake until the wheels begin turning again.

##### **WARNING**

If you leave children unattended in the vehicle, they may be able to set the vehicle in motion if, for example, they:



- release the parking brake
- shift the automatic transmission out of park position **P** or shift manual transmission into neutral
- start the engine

In addition, they may operate vehicle equipment and become trapped. There is a risk of an accident and injury.

When leaving the vehicle, always take the key with you and lock the vehicle. Never leave children unattended in the vehicle.

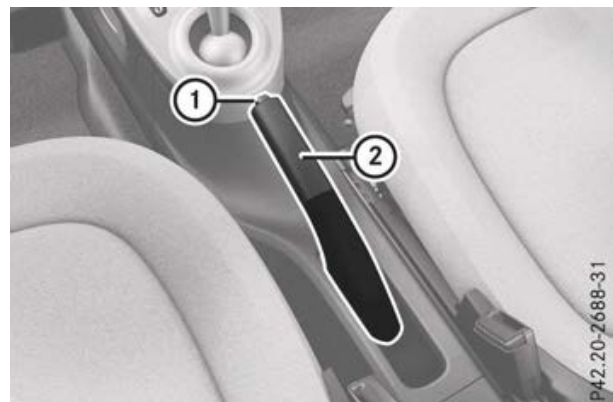
The brake lights do not light up when you brake the vehicle with the parking brake.



- ▶ **To apply:** firmly pull parking brake ② upwards.  
The  indicator lamp in the instrument cluster lights up if the engine is running.
- ▶ **To release:** depress the brake pedal and keep it depressed.
- ▶ Press release button ① on parking brake ② and guide the parking brake down to the stop.  
The  indicator lamp in the instrument cluster goes out.

The parking brake is not yet engaged if:

- a warning tone sounds
- the **Release parking brake** message appears in the multifunction display (vehicles with colour display) and
- the  indicator lamp in the instrument cluster lights up

### Parking up the vehicle

If you leave the vehicle parked up for longer than four weeks, the battery may be damaged by exhaustive discharging.

If you leave the vehicle parked up for longer than six weeks, it may suffer from lack of use.

- ▶ Visit a qualified specialist workshop and seek advice.

**i** You can obtain information about trickle chargers from a qualified specialist workshop.

### Driving tips

#### General notes

#### Important safety notes

##### **WARNING**

If you switch off the ignition while driving, safety-relevant functions are only available with limitations, or not at all.

This could affect, for example, the power steering and the brake boosting effect. You will require considerably more effort to steer and brake. There is a risk of an accident.

Do not switch off the ignition while driving.

### Drive sensibly – save fuel

Observe the following tips to save fuel:

- The tyres should always be inflated to the recommended tyre pressure.
- Remove unnecessary loads.
- Warm up the engine at low engine speeds.
- Avoid frequent acceleration or braking.
- Have all maintenance work carried out as indicated by the service intervals in the Service Booklet or by the service interval display.

Fuel consumption also increases when driving in cold weather, in stop-start traffic and in hilly terrain.

### eco score

#### General notes

The eco score display provides feedback on how economical your driving characteristics are. The eco score display assists you in achieving the most economical driving style for the selected settings and prevailing conditions. Consumption can be significantly influenced by your driving style.

In addition to driving style, the consumption is affected by many other factors, such as:

- load
- tyre pressure
- cold start
- choice of route
- the use of electrical consumers

These factors are not included in the eco score display.

### Vehicles with a monochrome display



The percentage count in eco score display ① only appears after a distance of approx. 400 m has been covered. A higher percentage count indicates a more economical driving style. If the ignition remains switched off for longer than 4 hours, eco score display ① in the on-board computer will be automatically reset.

- i** An economical driving style involves driving with a moderate engine speed. To achieve a higher value:
- observe the gearshift recommendation
  - accelerate moderately, especially at higher speeds
  - drive carefully and keep your distance from the vehicle in front
  - release the accelerator pedal in good time
  - allow the vehicle to coast without the use of the brakes and engage neutral if necessary
  - drive at a constant speed and avoid unnecessary acceleration and deceleration
  - drive the vehicle in drive program **E** (vehicles with automatic transmission).

- i** The eco score calculation takes into account your driving characteristics

from the start of the journey to its completion. Therefore, there are dynamic changes in the percentage count at the start of a journey. During a prolonged driving time, these changes are smaller. For dynamic changes, perform a manual reset (▷ page 161).

When the fuel level reaches the reserve range, the remaining fuel storage is shown in the multifunction display instead of the percentage value.

For further information on the eco score display, see (▷ page 161).

### Vehicles with a colour display



Vehicles with manual transmission



Vehicles with automatic transmission

The percentage count in the eco score display only appears after a distance of approx. 400 m has been covered. A higher percentage count indicates a more economical driving style. If the ignition remains switched off for longer than 4 hours, the eco score display in the on-board computer will be automatically reset.

**Vehicles with manual transmission:** the percentage count in the eco score display is an average value based on the following three categories:

- **accelerate** (evaluation of all acceleration processes)
  - The bar fills up: moderate acceleration, especially at higher speeds
  - The bar empties: sporty acceleration
- **anticipatory** (assessment of driving behaviour at all times)
  - The bar fills up: keep your distance, release the accelerator early and allow the vehicle to coast without using the brakes. Maintain a constant speed and avoid unnecessary acceleration and deceleration
  - The bar empties: fluctuations in speed, frequent braking
- **shift** (evaluation of all gear changes)
  - The bar fills up: observe the gearshift recommendations in the multifunction display
  - The bar empties: driving with the engine speed too high or too low

**Vehicles with automatic transmission:** the percentage count in the eco score display is an average value based on the following two categories:

- **accelerate** (evaluation of all acceleration processes)
  - The bar fills up: moderate acceleration, especially at higher speeds
  - The bar empties: sporty acceleration
- **anticipatory** (assessment of driving behaviour at all times)
  - The bar fills up: keep your distance, release the accelerator early and allow the vehicle to coast without using the brakes. Maintain a constant speed and avoid unnecessary acceleration and deceleration
  - The bar empties: fluctuations in speed, frequent braking

An economical driving style involves driving with a moderate engine speed.

**Vehicles with manual transmission:** to achieve a higher value in the **shift** category, observe the gearshift recommendations.

- ❗ On long journeys at a constant speed, e.g. on the motorway, only the bar for **anticipatory** will change.
- ❗ The eco score calculation takes into account your driving characteristics from the start of the journey to its completion. Therefore, there are dynamic changes in the bars at the start of a journey. During a prolonged driving time, these changes are smaller. For dynamic changes, perform a manual reset (▷ page 161).  
If you reset the data in the eco score display, then the data in the **from start** trip computer is also reset automatically (▷ page 160).

For further information on the eco score display, see (▷ page 161).

## Braking

### Important safety notes

#### WARNING

If you shift down on a slippery road surface in an attempt to increase the engine's braking effect, the drive wheels could lose their grip. This increases the risk of skidding and having an accident.

Do not shift down for additional engine braking on a slippery road surface.

### Downhill gradients

Change into a lower gear in good time on long and steep downhill gradients. Take particular note of this when driving a laden vehicle.

- i** This also applies if you have activated cruise control or the speed limiter.

This will use the braking effect of the engine, so less braking will be required to prevent the vehicle from gaining speed. This relieves the load on the brake system and prevents the brakes from overheating and wearing too quickly.

### Heavy and light loads

#### WARNING

The braking system can overheat if you leave your foot on the brake pedal while driving. This increases the braking distance and could even cause the braking system to fail. There is a risk of an accident. Never use the brake pedal as a footrest. Do not simultaneously depress both the brake pedal and the accelerator pedal while driving.

- !** Depressing the brake pedal constantly results in excessive and premature wear to the brake pads.

If heavy demands are made on the brakes, do not park the vehicle immediately. Drive on for a short while. This allows the airflow to cool the brakes more quickly.

If the brakes have been used only moderately, you should occasionally test their effectiveness. To do this, brake more firmly from a higher speed, paying attention to traffic conditions. This improves the grip of the brakes.

### Wet road surfaces

If you have driven for a long time in heavy rain without braking, there may be a delayed reaction from the brakes when braking for the first time. This may also occur after a car wash or after driving through deep water.

You have to depress the brake pedal more firmly. Maintain a greater distance from the vehicle in front.

After driving on a wet road or having the vehicle washed, brake firmly while paying attention to the traffic conditions. This will warm up the brake discs, thereby drying them more quickly and protecting them against corrosion.

### Limited braking performance on salt-treated roads

If you drive on salt-treated roads, a layer of salt may form on the brake discs and pads. This can increase the braking distance considerably.

- Brake occasionally to remove any salt that may have started to build up. Ensure that you do not endanger other road users when doing so.
- Carefully depress the brake pedal at the end of the journey and when starting the next journey.
- Maintain a much greater distance to the vehicle in front.

### New brake pads/linings

New or replaced brake pads/linings and discs only reach their optimum braking effect after several hundred kilometres of driving. Compensate for the reduced braking effect by applying greater force to the brake pedal.

When having brake pads/linings fitted, smart recommends that for safety reasons you only use those which are approved for smart vehicles or are of an equivalent quality standard. Brake pads/linings which have not been approved for smart vehicles or which are not of an equivalent quality could affect your vehicle's operating safety.

### Driving on wet roads

#### Aquaplaning

If water has accumulated to a certain depth on the road surface, there is a danger of aquaplaning occurring, even if:

- you are driving at low speeds
- the tyres have adequate tread depth

For this reason, in the event of heavy rain or in conditions in which aquaplaning can occur you must drive in the following manner:

- lower your speed
- avoid tyre ruts
- avoid sudden steering movements
- brake carefully

#### Driving on flooded roads

**!** Bear in mind that vehicles travelling in front or in the opposite direction create waves. This may cause the maximum permissible water depth to be exceeded.

These notes must be observed under all circumstances. You could otherwise damage the engine, the electronics or the transmission.

If you have to drive on stretches of road on which water has collected, please bear in mind that:

- the water level should not exceed the lower edge of the vehicle body in still water
- you should drive no faster than walking pace

### Winter driving

#### WARNING

If you shift down on a slippery road surface in an attempt to increase the engine's braking effect, the drive wheels could lose

their grip. This increases the risk of skidding and having an accident.

Do not shift down for additional engine braking on a slippery road surface.

#### DANGER

If the exhaust pipe is blocked or sufficient ventilation is not possible, poisonous exhaust gases such as carbon monoxide may enter the vehicle. This is the case, for example, if the vehicle gets stuck in snow. There is a risk of fatal injury.

If you have to leave the engine running, keep the exhaust pipe and the area around the vehicle free of snow. Open a window on the leeward side of the vehicle to ensure an adequate supply of fresh air.

Have your vehicle winterproofed at a qualified specialist workshop at the onset of winter.

You should drive particularly carefully on slippery road surfaces. Avoid sudden acceleration, steering and braking manoeuvres. Do not use cruise control.

If the vehicle threatens to skid or cannot be stopped when moving at low speed:

- ▶ Try to bring the vehicle under control by using corrective steering.
- ▶ **Vehicles with automatic transmission:** shift the transmission to position **N**.

The outside temperature indicator is not designed to serve as an ice-warning device and is therefore unsuitable for that purpose. Changes in the outside temperature are displayed after a short delay.

Indicated temperatures just above the freezing point do not guarantee that the road surface is free of ice. The road may still be icy, especially in wooded areas or on bridges.

You should pay special attention to road conditions when temperatures are around the freezing point.

For more information on driving with snow chains, see (▷ page 251).

For more information on driving with summer tyres, see (▷ page 250).

Observe the notes in the "Winter operation" section (▷ page 250).

## Driving systems

### Cruise control

#### General notes

Cruise control maintains a constant road speed for you. Cruise control does not brake the vehicle automatically. Only the engine's braking effect is available. In order to reduce speed and maintain distance to other road users, you need to brake yourself. This cancels cruise control.

Use cruise control only if road and traffic conditions make it appropriate to maintain a steady speed for a prolonged period. You can use cruise control at speeds above 30 km/h.

#### Important safety notes

If you fail to adapt your driving style, cruise control can neither reduce the risk of an accident nor override the laws of physics. Cruise control cannot take into account road, weather or traffic conditions. Cruise control is only an aid. You are responsible for the distance to the vehicle in front, for vehicle speed, for braking in good time, and for staying in lane.

Do not use cruise control:

- in road and traffic conditions which do not allow you to maintain a constant speed (e.g. in heavy traffic or on winding roads)
- on smooth or slippery roads. Braking or accelerating can cause the drive wheels

to lose traction and the vehicle could then skid

- when there is poor visibility, e.g. due to fog, heavy rain or snow

If there is a change of drivers, advise the new driver of the speed stored.

#### Cruise control buttons

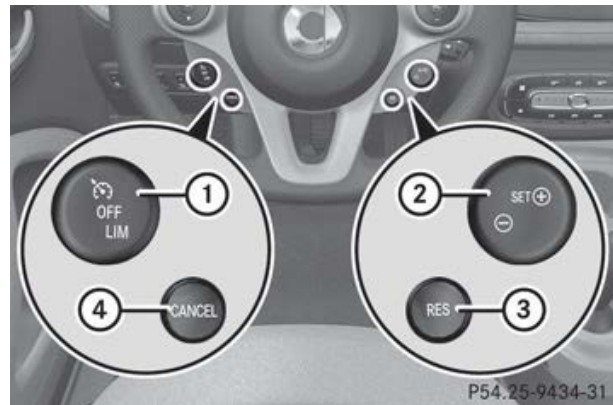

- ① Activates/deactivates cruise control
- ② Stores, increases or reduces the current speed
- ③ Calls up the last speed stored
- ④ Interrupts cruise control

#### Activating cruise control

Cruise control must be activated before it can be used.

- Press switch ① (  ).



Cruise control is activated.

The  symbol appears in the multi-function display.

- i** When you switch off the engine, cruise control remains activated and the last speed stored is cleared.

#### Storing and maintaining the current speed

When cruise control is active, you can save the current speed starting from 30 km/h.

- ▶ Accelerate the vehicle to the desired speed.
- ▶ Press switch ② (  ) and release it.
- ▶ Remove your foot from the accelerator pedal.  
Cruise control is activated. The vehicle automatically maintains the stored speed. The stored speed appears beside the  icon in the multifunction display.

**i** Cruise control may be unable to maintain the stored speed on uphill gradients. The stored speed is resumed when the gradient evens out.

On downhill gradients, only the engine's braking effect is available. You have to operate the brakes yourself to reduce speed. This cancels cruise control.

### Calling up the last speed stored

#### **WARNING**

If you call up the stored speed and this differs from your current speed, the vehicle will accelerate. If you do not know the stored speed, the vehicle can accelerate unexpectedly. There is a risk of an accident.



Before you call up the stored speed, pay attention to traffic conditions. If you do not know the stored speed, store the desired speed again.

- ▶ Press button ③ (  ) and release it.  
Cruise control is activated and adjusts the vehicle's speed to the last speed stored.
  - ▶ Remove your foot from the accelerator pedal.
- i** The last speed stored is cleared when you switch off the engine.

### Increasing or decreasing the speed

In order to be able to increase or decrease the speed, a speed must already have been stored.

**i** Cruise control is not deactivated if you depress the accelerator pedal. For example, if you accelerate briefly to overtake, cruise control adjusts the vehicle's speed to the last speed stored after you have finished overtaking.

- : increases the speed
- -: decreases the speed
- ▶ Press switch ② (  ) or (-) repeatedly until the desired speed is reached.  
The speed is gradually increased or reduced.

or

- ▶ Press and hold switch ② (  ) or (-) until the desired speed is reached.
- ▶ Release the switch.  
The new speed is stored.

### Cancelling cruise control

When cruise control is switched on, you can cancel cruise control at any time and call up the stored speed again later.

**i** The last speed stored is cleared when you switch off the engine.

- ▶ Press button ④ (  ) and release it.

or

- ▶ Brake  
Cruise control is cancelled.

Cruise control is also cancelled when:

- you engage the parking brake
- you depress the clutch
- esp<sup>®</sup> intervenes

### Deactivating cruise control

- ▶ Press switch ① so that the switch is set to the middle position.  
Cruise control is deactivated.

The  symbol goes out in the multi-function display.

- i** Once you have activated the limiter, cruise control is deactivated.

## Limiter

### General notes

The limiter helps you to avoid exceeding a set speed. The limiter does not brake the vehicle automatically. On long and steep downhill gradients, especially if the vehicle is laden, you must shift to a lower gear in time. By doing so, you will make use of the braking effect of the engine. The limiter may be unable to prevent the stored speed from being exceeded on downhill gradients. In this case, the stored speed flashes in the display and a warning tone sounds. Brake yourself, if necessary, to avoid exceeding the speed.

### Important safety notes

If you fail to adapt your driving style, the limiter can neither reduce the risk of an accident nor override the laws of physics. The limiter cannot take into account road, weather or traffic conditions. The limiter is only an aid. You are responsible for the distance to the vehicle in front, for vehicle speed, for braking in good time, and for staying in lane.

If there is a change of drivers, advise the new driver of the speed stored.

### Limiter buttons

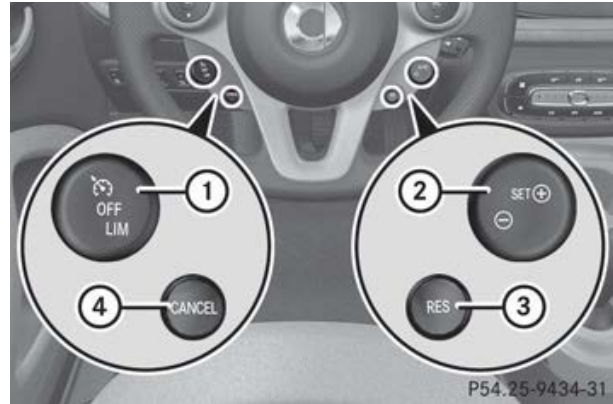

- ① Activates/deactivates the limiter
- ② Stores, increases or reduces the current speed
- ③ Calls up the last speed stored
- ④ Cancels the limiter

### Activating the limiter

The limiter must be activated before the speed limiter can be used.

- ▶ Press (LIM) switch ①. The limiter is activated.

The  symbol appears in the multi-function display.



- i** When you switch off the engine, the limiter remains activated and the last speed stored is cleared.

### Storing the speed

When the limiter is active, you can store any speed starting from 30 km/h.

You can save the current driving speed or you can set any desired speed while the vehicle is stationary.

Saving the current driving speed

- ▶ Accelerate the vehicle to the desired speed.
- ▶ Press switch ② () and release it. The limiter is activated. The stored speed appears beside the  icon in the multifunction display.

Setting a speed while the vehicle is stationary

- ▶ Press switch ② (  ) and release it. The limiter is activated. The stored speed appears beside the **LIM** icon in the multifunction display.

### Calling up the last speed stored

- ▶ Press button ③ (  ) and release it. The limiter is activated.

**i** The last speed stored is cleared when you switch off the engine.

### Increasing or decreasing the speed

In order to be able to increase or decrease the speed, a speed must already have been stored.

- : increases the speed
- -: decreases the speed
- ▶ Press switch ② (  ) or (-) repeatedly until the desired speed is reached. The speed is then gradually increased or decreased.

or

- ▶ Press and hold switch ② (  ) or (-) until the desired speed is reached. The speed will be increased or reduced in 10 km/h increments.
- ▶ Release the switch. The new speed is stored.

### Exceeding the stored speed

You can exceed the stored limit speed at any time, if you depress the accelerator pedal beyond the pressure point (kick-down). When the maximum speed is exceeded, the speed display flashes and a warning tone sounds. The limiter is activated again once the speed drops below the stored speed and kickdown is no longer active.

### Cancelling the limiter

When the limiter is activated, you can cancel it at any time and call up the stored speed again later.

- i** The last speed stored is cleared when you switch off the engine.
- ▶ Press button  ④ and release it. The limiter is cancelled.

### Deactivating the limiter

- ▶ Press the upper section of switch ① so that the switch is set in the middle position. The limiter is deactivated. The **LIM** symbol goes out in the multifunction display.

### Parking aid

#### General notes

The rear parking aid indicates audibly the distance between your vehicle and an object. If you engage reverse gear when the engine is running, the parking aid is activated automatically.

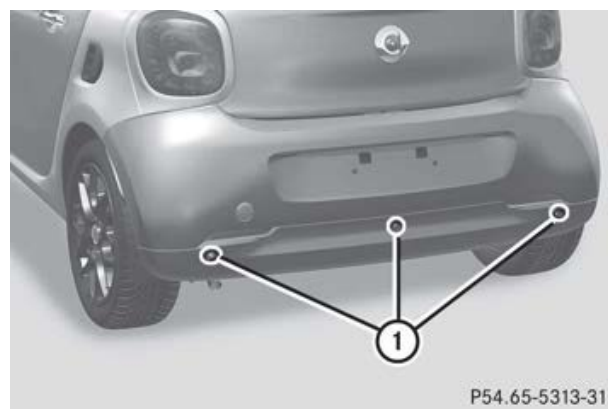

The parking aid monitors the rear area of your vehicle using three sensors ① in the rear bumper. The sensors must be free of dirt, ice and slush. Otherwise, they may not function correctly. Clean the sensors regularly, taking care not to scratch or damage them.

When reverse gear is engaged the system measures the distance between your vehicle and an object. If the proximity to the object behind the vehicle is less than 1.20 m, a beeping sound is issued. When the object is a maximum of 30 cm away, a continuous tone is issued.

### Important safety notes

The parking aid is only an aid. It is not a substitute for your attention to the immediate surroundings. The responsibility for safe manoeuvring and parking remains with you. Make sure that there are no persons, animals or objects in range while manoeuvring and parking.

**!** When parking, pay particular attention to objects above or below the sensors, such as flower pots or trailer drawbars. The parking aid does not detect such objects when they are in the immediate vicinity of the vehicle. You could damage the vehicle or the objects.

The sensors may not detect snow and other objects that absorb ultrasonic waves.

Ultrasonic sources such as an automatic car wash, the compressed-air brakes of a truck or a pneumatic drill could cause the parking aid to malfunction.

The parking aid may not function correctly on uneven terrain.

The parking aid does not take into account obstacles located:

- below the detection range, e.g. persons, animals or objects
- above the detection range, e.g. overhanging loads, tail sections or loading ramps of goods vehicles

### Deactivating/activating the parking aid

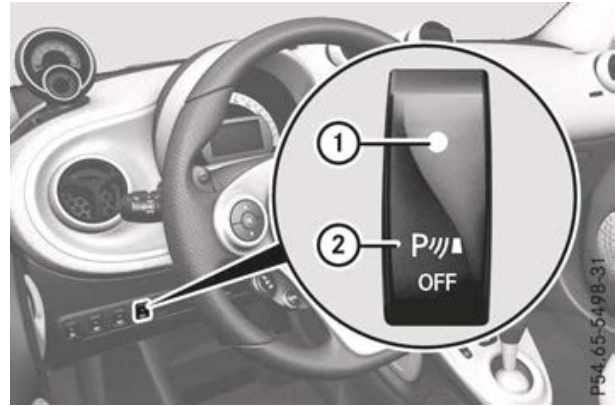

- ▶ Press button ②. Indicator lamp ① lights up. The system is deactivated.
- ▶ Press button ② again. Indicator lamp ① goes out. The system is reactivated.

**i** The parking aid is automatically activated when you start the engine.

If you engage reverse gear while the engine is running, the parking aid is activated automatically. An acoustic signal sounds when reverse gear is selected.

The parking aid is deactivated:

- when a speed of 10 km/h is exceeded
- reverse gear is no longer engaged

### Rear view camera

#### General notes

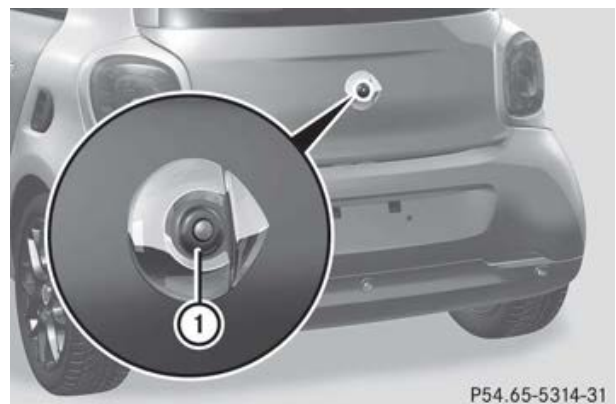

Reversing camera ① is an optical parking and manoeuvring aid. It shows the area



behind your vehicle with guide lines in the smart Media-System display.

The area behind the vehicle is displayed as a mirror image, as in the rear-view mirror.

- i** The text shown in the smart Media-System display depends on the language setting. The following are examples of reversing camera displays.

### Important safety notes

The reversing camera is only an aid. It is not a substitute for your attention to the immediate surroundings. The responsibility for safe manoeuvring and parking remains with you. Make sure that there are no persons, animals or objects in range while manoeuvring and parking.

Under the following circumstances, the reversing camera will not function, or will function in a limited manner:

- if the tailgate is open
- in heavy rain, snow or fog
- at night or in very dark places
- if the camera is exposed to very bright light
- if the area is lit by fluorescent light or LED lighting (the display may flicker)
- if there is a sudden change in temperature, e.g. when driving into a heated garage in winter
- if the camera lens is dirty or obstructed
- if the rear of your vehicle is damaged. In this event, have the camera position and setting checked at a qualified specialist workshop

The field of vision and other functions of the reversing camera may be restricted due to additional accessories on the rear of the vehicle (e.g. licence plate holder, bicycle rack).

### Activating/deactivating the reversing camera

- ▶ **To activate:** make sure that the key is in position **2** in the ignition lock.
- ▶ Make sure that **Reversing camera display** setting is selected in the smart Media-System (see separate operating instructions).
- ▶ Engage reverse gear.  
The area behind the vehicle is shown with guide lines in the smart Media-System display.

**To switch off:** after driving forwards briefly, the reversing camera will turn itself off.

### Messages in the display

The reversing camera may show a distorted view of obstacles or show them incorrectly or not at all. Obstacles are not shown by the reversing camera in the following locations:

- very close to the rear bumper
  - under the rear bumper
  - in the area immediately above the tailgate handle
- !** Objects not at ground level may appear to be further away than they actually are, e.g.:
- the bumper of a parked vehicle
  - the drawbar of a trailer
  - the ball coupling of a trailer tow hitch
  - the rear section of an HGV
  - a slanted post

Use the guidelines only for orientation. Approach objects no further than the bottom-most guideline.

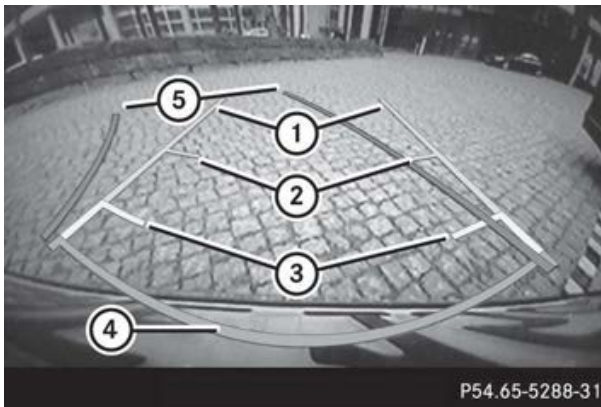

- ① Guide line without turning the steering wheel, vehicle width including the exterior mirrors (static)
- ② Green guide line at a distance of approximately 1.50 m from the rear of the vehicle
- ③ Yellow guide line at a distance of approximately 0.7 m from the rear of the vehicle
- ④ Red guide line at a distance of approximately 0.3 m from the rear of the vehicle
- ⑤ Blue guide line for the vehicle width including the exterior mirrors, for current steering wheel angle (dynamic)

The guide lines are shown when the transmission is in position **R**.

The distance specifications only apply to objects that are at ground level.

## Lane Keeping Assist

### General notes

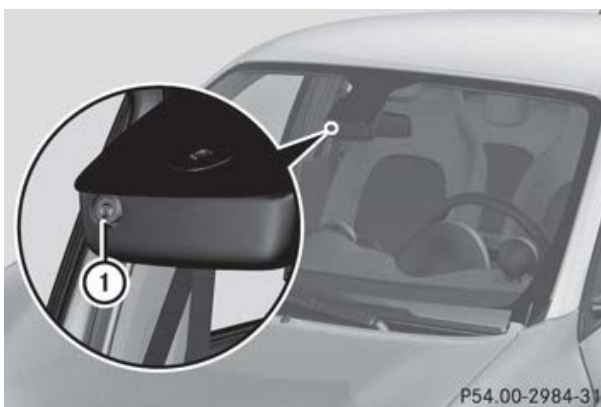

This feature warns the driver if a lane marking is crossed inadvertently. Lane Keeping Assist uses a camera ① which is affixed on the windscreen behind the rear view mirror.

A warning may be given if a front wheel passes over a lane marking. The corresponding symbol flashes for a maximum of five seconds in the display and a warning tone sounds.

### Important safety notes

#### **WARNING**

Lane Keeping Assist cannot always clearly identify lane markings.

In these cases, Lane Keeping Assist may:

- give an unnecessary warning
- not give a warning

There is a risk of an accident.

Always pay particular attention to the traffic situation and keep in lane, especially if Lane Keeping Assist alerts you.

#### **WARNING**

The Lane Keeping Assist warning does not return the vehicle to the original lane. There is a risk of an accident.

Always steer, apply the brakes or accelerate the vehicle yourself, especially if Lane Keeping Assist alerts you.

If you fail to adapt your driving style, Lane Keeping Assist can neither reduce the risk of an accident nor override the laws of physics. Lane Keeping Assist cannot take into account road, weather or traffic conditions. Lane Keeping Assist is only an aid. You are responsible for the distance to the vehicle in front, for vehicle speed, for braking in good time, and for staying in lane.

Lane Keeping Assist does not keep your vehicle in its lane.



The system may be impaired or may not function if:

- there is poor visibility, e.g. due to insufficient illumination of the road, or due to snow, rain, fog or spray
- there is glare, e.g. from oncoming traffic, the sun or reflection from other vehicles (e.g. if the road surface is wet)
- the windscreen is dirty, misted up, damaged or covered, for instance by a sticker, in the vicinity of the camera
- no, or several, unclear lane markings are present for one lane, e.g. in a construction area
- the lane markings are worn away, dark or covered up, e.g. by dirt or snow
- the distance to the vehicle in front is too small and the lane markings thus cannot be detected
- the lane markings change quickly, e.g. lanes branch off, cross one another or merge
- the road is narrow and winding
- there are highly variable shade conditions on the road

No warning occurs if:

- a lane marking is crossed at speed
- you have switched on the turn signals. In this case, the warnings are suppressed for a certain period of time
- you cut the corner on a sharp bend

### Activating/deactivating Lane Keeping Assist



### Vehicles with a colour display:

- ▶ **To switch on:** press button ②.

Indicator lamp ① goes out. In the display, the  symbol and the **Lane Keeping Assist on** message appear.

If you drive at speeds above 70 km/h and lane markings are detected, Lane Keeping Assist is operational. The  symbol appears in the display with a green background.

- ▶ **To deactivate:** press button ②.

Indicator lamp ① lights up. The  symbol in the display goes out. Lane Keeping Assist is deactivated. The **Lane Keeping Assist off** message appears in the display.

### Vehicles with a monochrome display

- ▶ **To switch on:** press the ② button.

Indicator lamp ① goes out. The  symbol appears in the display.

If you drive at speeds above 70 km/h and lane markings are detected, Lane Keeping Assist is operational. The  symbol appears in the display.

- ▶ **To deactivate:** press button ②.

Indicator lamp ① lights up. The  symbol in the display goes out. Lane Keeping Assist is deactivated.

- ⓘ Your selection remains stored when you switch off the engine.

Useful information .....	154
Important safety notes .....	154
Displays and operation .....	154
Menus and submenus .....	160
Display messages (on-board computer with monochrome display) .....	168
Display messages (on-board computer with colour display) .....	173
Warning and indicator lamps in the instrument cluster .....	190

### Useful information

- i** This Owner's Manual describes all models, series and optional equipment for your vehicle that were available at the time of going to press. Country-specific differences are possible. Note that your vehicle may not be fitted with all features described. This is also the case for systems and functions relevant to safety.
- i** Read the information on qualified specialist workshops: (▷ page 21).

### Important safety notes

#### WARNING

Operating the integrated information systems and communications equipment in the vehicle while driving will distract you from traffic conditions. You could then lose control of the vehicle. There is a risk of an accident.

Only operate these devices if road traffic conditions permit. If you are unsure about the surrounding conditions, pull over to a safe location and make entries only while the vehicle is stationary.

You must observe the legal requirements for the country in which you are currently driving when operating the on-board computer.

#### WARNING

If the instrument cluster has failed or malfunctioned, you may not recognise function restrictions relevant to safety. The operating safety of your vehicle may be impaired. There is a risk of an accident. Drive on carefully. Have the vehicle checked at a qualified specialist workshop immediately.

The on-board computer only shows display messages and/or warnings from certain systems in the display. You should there-

fore make sure your vehicle is operating safely at all times. Otherwise, you may cause an accident by driving a vehicle that is not operating reliably.

If the operating safety of your vehicle is impaired, park the vehicle as soon as possible, paying attention to road and traffic conditions. Contact a qualified specialist workshop.

Observe the notes in the overview of warning and indicator lamps in the instrument cluster:

- On-board computer with a black and white display (▷ page 28)
- On-board computer with a colour display (▷ page 30)

## Displays and operation

### Instrument cluster lighting

Instrument cluster lighting includes illumination of the instrument cluster, the additional instruments on the dashboard, the displays and the controls.

The instrument cluster lighting is switched automatically between day and night lighting depending on the ambient light conditions (▷ page 93).

On vehicles with a colour display, you can also set the brightness of the instrument cluster lighting to different levels in the on-board computer (▷ page 164).

### Speedometer

If you turn the key to position **2** in the ignition lock, the warning and indicator lamps in the instrument cluster will briefly light up for a lamp test. During the lamp test, the illuminated speedometer needle moves in the speedometer.

The on-board computer with a colour display can show a digital speedometer in the display. The digital speedometer can be

hidden/displayed and its speed unit selected (▷ page 165).

**Outside temperature display**

You should pay special attention to road conditions when temperatures are around freezing point.

Bear in mind that the outside temperature display indicates the temperature measured and does not record the road temperature.

The display shows the outside temperature on the far right in the header:

- monochrome display (▷ page 157)
- colour display (▷ page 159)

Changes in the outside temperature are displayed after a short delay.

If the outside temperature has fallen below 3 °C, the ❄ symbol is shown beside the outside temperature display.

At outside temperatures between -3 °C and 3 °C:

- the ❄ symbol flashes for about 1 minute in the black and white display and then remains on continuously
- the colour display also shows a display message next to the ❄ symbol (▷ page 179)

For an on-board computer with colour display, you can set the temperature unit of the outside temperature display (▷ page 166).

**Fuel gauge**

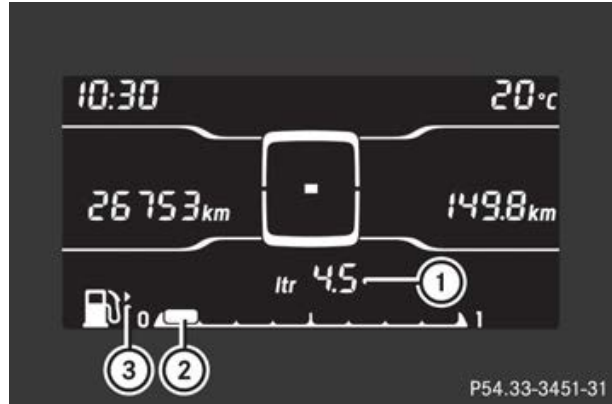

Fuel level indicator (example: monochrome display)



Fuel level indicator (example: colour display)

- ① Reserve fuel display
- ② Fuel gauge
- ③ Fuel filler flap location indicator  
▶ The fuel filler cap is located on the right
- ④ Reserve fuel (yellow)

Fuel gauge ② is shown in the display as a segment display with eight segments.

When the fuel level falls below the reserve range of 5.0 l, the last illuminated segment of the fuel display will flash and a warning tone will sound. Reserve fuel display ① will also appear. The reserve fuel display shows the numeric value of the remaining fuel level in 0.5 l increments.

With a colour display:

- symbol ④ also appears in yellow
- a display message is also shown (▷ page 181).



### Additional instruments on the dashboard

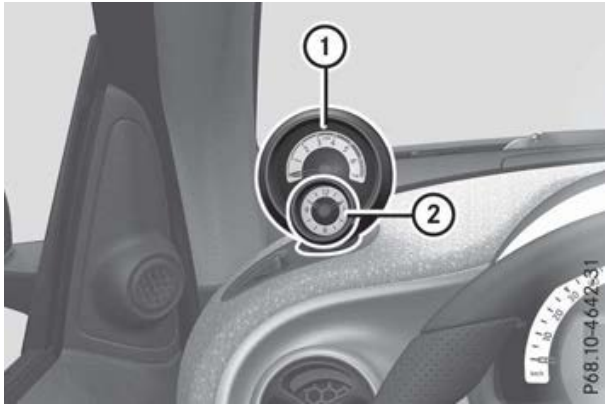

⚠ Do not drive in the overrevving range. Doing so will damage the engine.

#### 🌿 Environmental note

Avoid excessive engine speeds. This unnecessarily increases the fuel consumption of your vehicle and harms the environment as a result of increased emissions.

The overrevving range of the engine is shown with dashed lines in the orange marking of rev counter ①. The fuel supply is interrupted to protect the engine when the overrevving range is reached.

Dashboard clock ② is synchronised with the clock in the on-board computer.

Rev counter ①, together with dashboard clock ②, can be rotated approximately 60° on the dashboard.

For vehicles with a colour display, you can also set the brightness of the instrument cluster lighting to different levels (▷ page 164).

### On-board computer with a monochrome display

#### Operating the on-board computer



- ① Monochrome display
- ② Buttons on the multifunction lever

► **To activate the on-board computer:** unlock the vehicle and open a door. If you do not subsequently lock the door, the on-board computer will remain active for approximately 15 minutes without any further activity.

or

► Turn the key to position **1** in the ignition lock.

You can control the display and the settings in the on-board computer using buttons ② on the multifunction lever.

**Buttons ② on the multifunction lever**

	<p><b>Press briefly:</b></p> <ul style="list-style-type: none"> <li>To scroll forward at menu level</li> <li>To gradually increase the value in the sub-menus</li> </ul> <p><b>Press and hold:</b></p> <ul style="list-style-type: none"> <li>To switch directly to the trip meter at menu level</li> <li>To quickly increase the value in the sub-menus</li> </ul>
<b>OK</b>	<p><b>Press briefly:</b></p> <ul style="list-style-type: none"> <li>To confirm the setting in the sub-menu</li> </ul> <p><b>Press and hold:</b></p> <ul style="list-style-type: none"> <li>To reset the value at menu level or call up the sub-menu</li> </ul>

**Monochrome display**

**Vehicles with manual transmission**

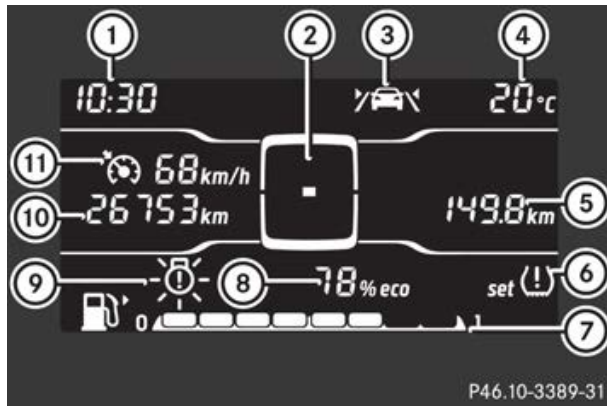

- ① Time (▷ page 158)
- ② Transmission display
  - Gearshift recommendation (▷ page 128)
  - Standard display
  - Transmission malfunction (▷ page 170)
- ③ Lane Keeping Assist indicator lamp (▷ page 151)
- ④ Outside temperature display (▷ page 155)
- ⑤ Trip meter (▷ page 158)

Current fuel consumption (▷ page 158)  
Service display (▷ page 218)

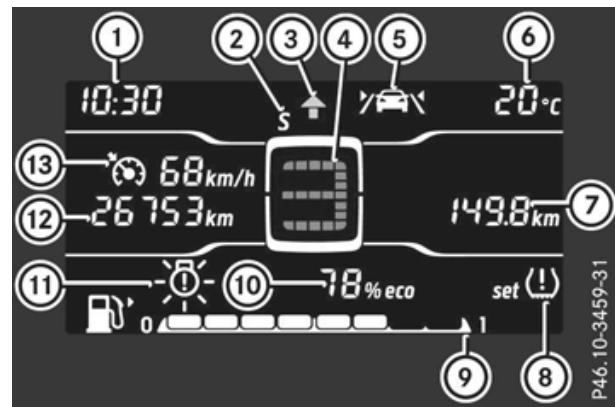

- ⑥ Restarts the tyre pressure monitor (▷ page 254)
- ⑦ Fuel level (▷ page 155)
- ⑧ eco score display (▷ page 140)  
Reserve fuel display (▷ page 155)
- ⑨ Brake lamp failure warning lamp (▷ page 168)
- ⑩ Total distance recorder
- ⑪ Cruise control (▷ page 145)  
**LIM** Limiter

**Vehicles with automatic transmission**



- ① Time (▷ page 158)
- ② Drive program (▷ page 129)
- ③ Gearshift recommendation (▷ page 128)
- ④ Transmission display
  - Standard display or  
3 Gear indicator (manual mode)
  - Transmission malfunction (▷ page 170)
- ⑤ Lane Keeping Assist indicator lamp (▷ page 151)
- ⑥ Outside temperature display (▷ page 155)
- ⑦ Trip meter (▷ page 158)  
Current fuel consumption (▷ page 158)  
Service display (▷ page 218)
- ⑧ Restarts the tyre pressure monitor (▷ page 254)
- ⑨ Fuel level (▷ page 155)





- ⑩ eco score display (▷ page 140)  
Reserve fuel display (▷ page 155)
- ⑪  Brake lamp failure warning lamp  
(▷ page 168)
- ⑫ Total distance recorder
- ⑬  Cruise control (▷ page 145)  
 Limiter

## Menus and multi-displays

### Overview

The arrangement of the menus and displays can be envisaged as a circle.

- ▶ **To scroll:** repeatedly press the  button on the multifunction lever.  
The menu functions/displays are shown one after the other.

- i** If the  button is pressed and held for approximately 3 seconds, the trip meter appears directly on the display.

Depending on the vehicle equipment, you can call up the following menus/displays one after the other:

- display and reset the trip meter  
(▷ page 158)
- display the current fuel consumption  
(▷ page 158)
- display the service due date  
(▷ page 218)
- set the time menu (▷ page 158)
- restart the tyre pressure monitor  
(▷ page 254)

### Resetting values

You can reset the trip meter data and the eco score display (▷ page 140). You can only reset the eco score if the display is showing the current fuel consumption.



- ▶ Repeatedly press the  button on the multifunction lever until the display

shows the trip meter data or the current fuel consumption.

- ▶ Press and hold the  button on the multifunction lever.

The trip meter value or the eco score display flashes for approx. 3 seconds. The data is then reset.







The count in the eco score display only reappears once a distance of approx. 400 m has been covered. If the ignition remains switched off for longer than four hours, the eco score display in the on-board computer will be automatically reset.

- ▶ When the value has been reset, release the  button.  
If you release the  button earlier, the data shown will not change.

### Current fuel consumption

When the vehicle is stationary or up to a speed of approximately 5 km/h, the display shows the current fuel consumption as a numeric value in l/h.

### Setting the time

- ▶ Repeatedly press the  button on the multifunction lever until the display shows the  symbol alongside the time.
- ▶ Press and hold the  button on the multifunction lever until the hour value flashes.
- ▶ Press  to set the hour and confirm the selection with .  
The minute value flashes.
- ▶ Press  to set the minutes and  to confirm the selection.  
The display will show the time selected.

- i** If the  button on the multifunction lever is pressed and held when setting the time, the numerical values will change continuously.

**On-board computer with a colour display**

**Operating the on-board computer**



- ① Colour display
- ② Left control panel

► **To activate the on-board computer:** unlock the vehicle and open a door. If you do not subsequently lock the door, the on-board computer will remain active for approximately 15 minutes without any further activity.

or

► Turn the key to position **1** in the ignition lock.

You can control the display and the settings in the on-board computer using the steering wheel buttons on left control panel ②.

**Left control panel ②**

▲	<b>Press briefly:</b>
▼	
	<ul style="list-style-type: none"> <li>• To scroll through a menu</li> <li>• To scroll through a sub-menu or list</li> </ul>
	<b>Press and hold:</b>
	<ul style="list-style-type: none"> <li>• To switch directly to the <b>Distance</b> menu at menu level</li> <li>• To switch directly to the <b>back</b> function at the submenu level</li> </ul>
OK	<ul style="list-style-type: none"> <li>• To confirm the selection</li> <li>• In certain menus, to switch to the <b>Reset values?</b> function</li> <li>• To hide the display message</li> </ul>

**Colour display**

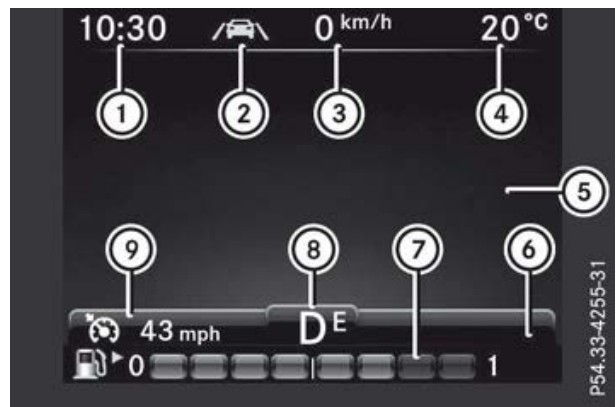

- ① Time (▷ page 163)
  - ② Lane Keeping Assist indicator lamp (▷ page 151)
  - ③ Digital speedometer (▷ page 165)
  - ④ Outside temperature display (▷ page 155)
  - ⑤ Display field for display messages, menus and lists
  - ⑥ Reserve fuel display (▷ page 155)
  - ⑦ Fuel level (▷ page 155)
  - ⑧ Transmission display
- Vehicles with manual transmission:
- Standard display

>> On-board computer and displays.



Vehicles with automatic transmission:

- D Standard display with drive program or 3 Gear indicator (manual mode)
- ↑↓ Gearshift recommendation (▷ page 128)
- ≡ Transmission malfunction (▷ page 189)
- ⑨ CC Cruise control (▷ page 145)
- LIM Limiter

## Menus and submenus

### Menu overview

The arrangement of the menus and displays can be envisaged as a circle.

At the menu level, a segment display is shown on the right side of the display to help navigation. The segment marked corresponds with the list position of the menu in the following list. For long lists within the menus and submenus, a scroll bar on the right side of the display serves to assist orientation.

Operating the on-board computer (▷ page 159).

Depending on the vehicle equipment, you can call up the following menus one after the other:

- **Distance** menu (▷ page 160)
- **from start** trip computer menu (▷ page 160)
- **from reset** trip computer menu (▷ page 160)
- **eco score from start** menu (▷ page 161)
- **Fuel consumption** menu (▷ page 162)
- **Coolant temperature** menu (▷ page 162)
- **Messages and service** menu (▷ page 162)
- **Settings** menu (▷ page 163)

### Odometer menu



Example: distance

- ▶ **To show:** press the ▲ or ▼ button on the steering wheel to select the trip meter display. The display shows trip meter ① and total distance recorder ②.
- ▶ **To reset the data:** press the OK button on the steering wheel.
- ▶ Press the ▲ or ▼ button to select **yes** and press the OK button to confirm. The trip meter is reset.

You can change the unit for the trip meter in the **Display** submenu (▷ page 165).

### Trip computer menu "From start" or "From reset"

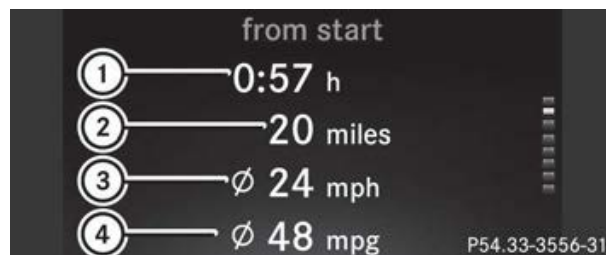

Example: trip computer "From start"

- ① Elapsed time
- ② Distance
- ③ Average speed
- ④ Average fuel consumption
- ▶ **To display:** press the ▲ or ▼ button on the steering wheel to select the **from start** or **from reset** trip computer menu.

If you reset the data in the **from start** trip computer, the eco score display in the on-

board computer is also reset automatically (▷ page 161).

**Vehicles with a smart Media-System:** if you reset the data in the **from reset** trip computer, the eco score display in the smart Media-System will also be reset automatically (see the separate operating instructions).

- ▶ **To reset the data:** press the **OK** button on the steering wheel.
- ▶ Press the **▲** or **▼** button to select **yes** and press the **OK** button to confirm. The display shows the trip computer and the data shown is reset.

The average speed and average fuel consumption are only displayed again once a distance of approx. 400 m has been covered.

The data in the **from start** trip computer menu refers to the start of the journey. The data in the **from reset** trip computer submenu refers to the last time the submenu was reset.

The **from start** trip computer is automatically reset when:

- the ignition has been switched off for more than 4 hours
- 999 hours have been exceeded
- 9999 kilometres have been exceeded

The **from reset** trip computer is automatically reset if the value exceeds 9999 hours or 99,999 kilometres.

The unit of distance for the journey, speed and consumption information can be changed in the **Display** submenu (▷ page 165).

#### eco score from start menu



eco score display (vehicles with manual transmission)



eco score display (vehicles with automatic transmission)

- ▶ **To display:** press the **▲** or **▼** button on the steering wheel to select the **eco score from start** menu.

If you reset the data in the eco score display, then the data in the **from start** trip computer is also reset automatically (▷ page 160).

- ▶ **To reset the data:** press the **OK** button on the steering wheel.
- ▶ Press the **▲** or **▼** button to select **yes** and press the **OK** button to confirm. The display shows the eco score display and the data shown is reset.

The percentage count in the eco score display only reappears once a distance of approx. 400 m has been covered.

If the ignition remains switched off for longer than 4 hours, the eco score display in the on-board computer will be automatically reset.

For further information on the eco score display, see (▷ page 140).

### Fuel consumption menu



Example: fuel consumption

- ▶ Press the or button on the steering wheel to select the display of current fuel consumption.

The display shows the fuel consumption over the previous 15 minutes as a bar chart. The display additionally shows the current fuel consumption as a numeric value in the upper right section of the display.

When the vehicle is stationary or up to a speed of approximately 5 km/h, the display shows the current fuel consumption as a numeric value in l/h. If you have changed the unit of measurement for distance to **Miles**, the display shows two dashes.

If you switch off the ignition, or change the distance unit, the fuel consumption data is deleted automatically.

You can change the distance unit in the **Display** submenu (▷ page 165).

### Coolant temperature menu

Under normal operating conditions and with the specified coolant level, the coolant temperature may rise to 110 °C.

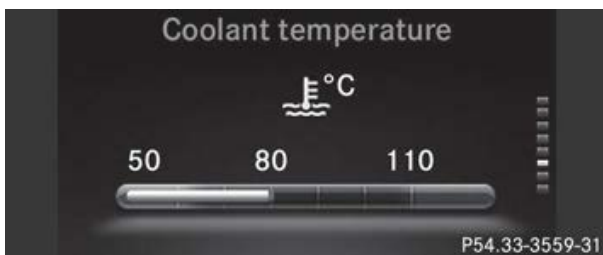

Example: coolant temperature

- ▶ Press the or button on the steering wheel to select the coolant temperature display.

The display shows the current coolant temperature as a bar in the range between 50 and 110 °C.

If the coolant temperature rises above 110 °C, then the display shows a display message (▷ page 181). Observe the display message. You could otherwise damage the engine.

You can change the temperature unit in the **Display** submenu (▷ page 166).

### Messages and service menu

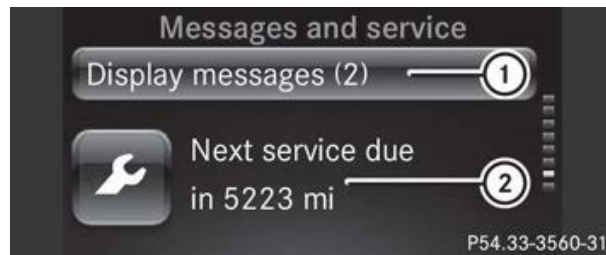

Example: messages and service

If you have hidden display messages these are saved in the message memory. The menu shows the number of display messages in message memory ① and next service due date ② (▷ page 218). The message memory can only be called up when the ignition is switched on.

- ▶ Press the or button on the steering wheel to select the **Messages and service** menu.

The display shows the number of display messages in the message memory and the next service due date.

If there are no display messages, then the value in brackets is 0 and the information on the button is hidden.

- ▶ **To show display messages:** press the button on the steering wheel. The lower area on the right of the display shows the display message, its list num-

ber and then number of display messages in the message memory.

- ▶ Press  to scroll through the display messages in the message memory.

Pressing  only allows you to scroll back to messages which have already been read.

If you scroll back from the first display message using , the **Messages and service** menu will again be shown in the display. Existing display messages are not shown.

## Settings menu

### Introduction

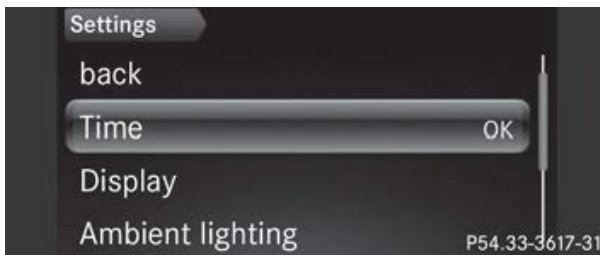

In the **Settings** menu, as well as in its submenus, a navigation bar is also shown at the top of the display field. The navigation bar serves for quick orientation and shows the navigation path to the current selection shown in the display (submenu/function). The selection shown in the display is highlighted in the navigation path.

Depending on the vehicle equipment, you can call up the following submenus in the **Settings** menu:



- **Time** submenu (▷ page 163)

For vehicles with a smart media system, the time is set using the smart media system.



- Setting the time and the time format (12/24 h)
- **Display** submenu (▷ page 164)
  - Adjusting the instrument cluster lighting
  - Shows and sets the digital speedometer
  - Setting the units for distance and temperature
- **Ambient lighting** submenu (▷ page 166)
  - Setting and switching the ambient lighting on/off
- **Tyre pressure monitor** submenu
  - Restarts the tyre pressure monitor (▷ page 254)
- **Language (Language)** submenu (▷ page 166)
  - Setting the menu language

The **Settings** menu and some submenus also show the **back** function.

If the **back** function is shown, you have to select the function to leave the menu.

- ▶ Press the  or  button on the steering wheel to select the **back** function and press  on the steering wheel to confirm.

You quit the menu and the display shows the next higher menu level.

- i** If you press and hold  or , you change directly to the **back** function.



## Time submenu

### Introduction



This submenu is not available on vehicles with a smart media system. You set the time using the smart media system.

The **Time** submenu offers the following options:















- setting the time
- setting the time format (12/24 h)



- ▶ **To leave the submenu:** press the  or  button on the steering wheel to select the **back** function and press  on the steering wheel to confirm.

The display shows the **Settings** menu.













- ⓘ If you press and hold  or , you change directly to the **back** function.

### Setting the time

- ▶ Press the  or  button on the steering wheel to select the **Settings** menu and press  on the steering wheel to confirm.
- ▶ Press the  or  button to select the **Time** submenu and confirm with .
- ▶ Press the  or  button to select **Set the time** and press the  button to confirm.
- ▶ Press the  or  button to set the hour and confirm with .
- ▶ Press the  or  button to set the minutes and confirm with . The time is set and the display shows the **Time** submenu.

- ⓘ If you are setting the time and keep the  or  button depressed, then the numerical value changes continuously.

### Setting the time format (12/24 h)



- ▶ Press the  or  button on the steering wheel to select the **Settings** menu and press  on the steering wheel to confirm.
  - ▶ Press the  or  button to select the **Time** submenu and confirm with .
  - ▶ Press  or  to select **Time format (12/24 h)** and confirm with .
  - ▶ Press  or  to select the desired time format **24 hour** or **12 hour (am/pm)** and confirm with .
- The time format is accepted and the display shows the **Time** submenu.



## Display submenu

### Introduction

In the **Display** submenu, you can call up the following submenus:

- **Display/switch brightness** submenu (▷ page 164)
  - Adjusting the instrument cluster lighting
- **Digital speedometer** submenu, see (▷ page 165)
  - Shows and sets the digital speedometer
- **Units of distance** submenu (▷ page 165)
  - Setting the units of distance
- **Units of temperature** submenu (▷ page 166)
  - Setting the units of temperature









- ▶ **To leave the submenu:** press the  or  button on the steering wheel to select the **back** function and press  on the steering wheel to confirm. The display shows the **Settings** menu.



- ⓘ If you press and hold  or , you change directly to the **back** function.

### Adjusting the instrument cluster lighting

Instrument cluster lighting includes illumination of the instrument cluster, the additional instruments on the dashboard, the displays and the controls.



















You can set the brightness of the instrument cluster to different levels with the **Display/switch brightness** function.



- ▶ Press the  or  button on the steering wheel to select the **Settings** menu and press  on the steering wheel to confirm.
- ▶ Press the  or  button to select the **Display** submenu and confirm with .
- ▶ Press the  or  button to select **Display/switch brightness** and press the  button to confirm.



- ▶ Press the  or  button to set the brightness level. Level **1** corresponds to dimmed instrument lighting and level **5** to bright instrument lighting. With the selection during night-time driving, the instrument cluster brightness level is set at the same time.
- ▶ Press the  button to confirm the setting. The instrument lighting is set and the display shows the **Display** submenu.

### Digital speedometer submenu

In the **Digital speedometer** submenu you have the following options:

- showing/hiding the digital speedometer
- setting the unit for speed in the digital speedometer
- ▶ **To call up the submenu:** press the  or  button on the steering wheel to select the **Settings** menu and press  on the steering wheel to confirm.
- ▶ Press the  or  button to select the **Display** submenu and confirm with .
- ▶ Press the  or  button to select the **Digital speedometer** submenu and confirm with .
- ▶ **To show/hide the digital speedometer:** press the  or  button to select the **On** function.
- ▶ Activate or deactivate the **On** function by pressing the  button. When the function is highlighted, it is activated and the display shows the digital speedometer (▷ page 159).
- ▶ **To set the unit of speed:** press the  or  button to select **Unit** and press the  button to confirm.
- ▶ Press the  or  button to select the unit of speed **km/h** or **mph** and confirm with . The display shows the **Digital speedometer** submenu.

- ▶ **To leave the submenu:** press the  or  button to select the **back** function and confirm with . The display shows the **Display** submenu.

**i** If you press and hold  or , you change directly to the **back** function.













### Setting the unit of measurement for distance

If you change the unit of measurement for distance, the values in the:

- trip computer "From start" or "From reset" (▷ page 160)
- eco score from start (▷ page 161)
- fuel consumption (▷ page 162)













menus are also reset automatically.

You can only set the unit of measurement for distance when the vehicle is stationary.

- ▶ Press the  or  button on the steering wheel to select the **Settings** menu and press  on the steering wheel to confirm.
  - ▶ Press the  or  button to select the **Display** submenu and confirm with .
  - ▶ Press the  or  button to select **Units of distance** and press the  button to confirm.
  - ▶ Press the  or  button to select **Kilometres** or **Miles** as the unit of measurement for distance and press  to confirm. The display shows the **Display** submenu.
- The selected unit of measurement for distance applies as the basis for:
- the trip computer
  - the service display
  - the fuel consumption display
  - the total distance recorder and the trip meter display
  - the speed display for cruise control and the limiter

### Setting the temperature unit

You can switch the display of the outside temperature and the coolant temperature between °C and °F.

- ▶ Press the  or  button on the steering wheel to select the **Settings** menu and press  on the steering wheel to confirm.
- ▶ Press the  or  button to select the **Display** submenu and confirm with .
- ▶ Press the  or  button to select **Units of temperature** and press the  button to confirm.
- ▶ Press the  or  button to select the unit of temperature °C or °F and confirm with .



The display shows the **Display** submenu.

## Ambient lighting submenu



---

### Introduction







In the **Ambient lighting** submenu you have the following options:



- switching the ambient lighting on/off
- setting the brightness of the ambient lighting to different levels
- ▶ **To leave the submenu:** press the  or  button on the steering wheel to select the **back** function and press  on the steering wheel to confirm.

The display shows the **Settings** menu.

- i** If you press and hold  or , you change directly to the **back** function.













### Switching the ambient lighting on/off

- ▶ Press the  or  button on the steering wheel to select the **Settings** menu and press  on the steering wheel to confirm.
- ▶ Press the  or  button to select the **Ambient lighting** submenu and confirm by pressing the .

- ▶ Press the  or  button to select the **On** function.
- ▶ Activate or deactivate the **On** function by pressing the  button.  
When the function is highlighted it is activated and the ambient lighting is switched on.









### Setting the brightness



You can set the brightness of the ambient lighting to different levels.

- ▶ Press the  or  button on the steering wheel to select the **Settings** menu and press  on the steering wheel to confirm.
- ▶ Press the  or  button to select the **Ambient lighting** submenu and confirm by pressing the  button. You will see the selected setting.
- ▶ Press the  or  button to select **Brightness** and press the  button to confirm.
- ▶ Press the  or  button to set the brightness level. Level **1** corresponds to dimmed ambient lighting and level **5** to bright ambient lighting.  
With the selection, the ambient lighting brightness level is set at the same time.
- ▶ Press the  button to save the setting. The brightness of the ambient lighting is set and the display shows the **Ambient lighting** submenu.



## Language submenu

---

- ▶ Press the  or  button on the steering wheel to select the **Settings** menu and press  on the steering wheel to confirm.
- ▶ Use  or  to select the **Language (Language)** submenu and confirm with .
- ▶ Press the  or  button to select the desired language for the displays and messages and confirm with .

- ▶ Press the  or  button on the steering wheel to select the **back** function and press  on the steering wheel to confirm.

The display shows the **Settings** menu in the selected language.

- i** If you press and hold  or , you change directly to the **back** function.

## Display messages (on-board computer with monochrome display)



### Introduction

Warnings, malfunctions or additional information are shown in the monochrome display as symbols. For certain display messages a warning tone also sounds.















Display messages with graphic symbols are simplified in the Owner's Manual and may differ from the symbols in the display.





Please respond in accordance with the display messages and follow the additional notes in this Owner's Manual. The cause of a display message should be remedied as soon as possible.







### Display messages



Display messages	Possible causes/consequences and ► Solutions
	<p>The symbol lights up. The brake lights are not functioning. The actuation or the bulbs or LEDs are faulty.</p> <p> <b>WARNING</b></p> <p>Bulbs and lamps are an important aspect of vehicle safety. The brake lamps are not functioning and are no longer working when braking. There is a risk of an accident.</p> <ul style="list-style-type: none"> <li>► Pull over and stop the vehicle safely as soon as possible, paying attention to road and traffic conditions.</li> <li>► Secure the vehicle against rolling away (▷ page 138).</li> <li>► Consult a qualified specialist workshop.</li> </ul>
	<p><b>Vehicles with manual transmission only:</b> letter <b>N</b> flashes in the middle of the display. You are trying to start the engine, a gear is engaged and the clutch pedal is not fully depressed. To start the engine:</p> <ul style="list-style-type: none"> <li>► Engage neutral. (▷ page 127)</li> </ul> <p>or</p> <ul style="list-style-type: none"> <li>► Depress the clutch pedal fully.</li> </ul> <p>If the engine fails to start despite the clutch pedal being fully depressed, then the clutch sensor is malfunctioning.</p> <ul style="list-style-type: none"> <li>► Visit a qualified specialist workshop.</li> </ul>

Display messages	Possible causes/consequences and ► Solutions
	<p><b>Only for vehicles with automatic transmission:</b> the letter <b>N</b> flashes in the middle of the display if you try to shift to <b>P</b>. A warning tone also sounds.</p> <p>The parking lock is malfunctioning.</p> <p>► Apply the parking brake to park.</p>
<p><b>N</b> or <b>P</b></p>	<p><b>Vehicles with automatic transmission only:</b> <b>P</b> or <b>N</b> flash alternately in the middle of the display.</p> <p>You have attempted to start the engine with the transmission in position <b>D</b> or <b>R</b>.</p> <p>► Shift to <b>P</b> or <b>N</b> to start.</p>
<p><b>N</b> or <b>D</b> / <b>R</b></p>	<p><b>Vehicles with automatic transmission only:</b> <b>N</b> flashes alternately with the currently selected transmission position in the middle of the display.</p> <p>The engine switches off while the vehicle is in motion.</p> <p>► Shift to <b>N</b> to start.</p>
<p><b>B</b></p>	<p><b>Vehicles with automatic transmission only:</b> <b>B</b> flashes for 15 seconds in the middle of the display.</p> <p>You have tried to start the engine in transmission position <b>N</b> without depressing the brake pedal.</p> <p>► Depress the brake pedal.</p>
<p><b>P</b> or <b>D</b> / <b>R</b>, <b>N</b></p>	<p><b>Vehicles with automatic transmission only:</b> <b>P</b> flashes alternately with the currently selected transmission position. A warning tone also sounds.</p> <p>The driver's door is open/not fully closed and the gear lever is in position <b>R</b>, <b>N</b> or <b>D</b>.</p> <p> <b>WARNING</b></p> <p>The vehicle may roll away. There is a risk of an accident.</p> <p>► Shift the selector lever to position <b>P</b>. ► Secure the vehicle to prevent it from rolling away. ► Fully close the driver's door.</p>

Display messages	Possible causes/consequences and ► Solutions
	<p><b>Vehicles with manual transmission only:</b> the transmission display shows three lines.</p> <p>The transmission electronics are malfunctioning or the idling sensor is faulty.</p> <p>The Start/Stop function and cruise control are deactivated automatically.</p> <p>Starting the engine is only possible with the clutch pedal fully depressed.</p> <p>► Visit a qualified specialist workshop.</p>
	<p><b>Vehicles with automatic transmission only:</b> the transmission display shows three lines.</p> <p>The automatic transmission is malfunctioning.</p> <p>► Consult a qualified specialist workshop.</p>
 or  /  /  / 	<p><b>Vehicles with automatic transmission only:</b>  flashes alternately with the currently selected transmission position.</p> <p>The automatic transmission clutch has overheated. You will feel the clutch pedal pulsate.</p> <p>► Initially try to avoid pulling away or crawling manoeuvres. If the display message disappears, automatic transmission is available again.</p>
 or  /  /  / 	<p><b>Only for vehicles with automatic transmission:</b>  flashes alternately with the currently selected transmission position. A warning tone also sounds.</p> <p>Further pulling away or crawling manoeuvres have led to a critical clutch temperature.</p> <p>► Pull over and stop the vehicle safely as soon as possible, paying attention to road and traffic conditions.</p> <p>► Secure the vehicle to prevent it from rolling away.</p> <p>► Wait until the automatic transmission has cooled down and the display message does not reappear after acknowledging it.</p>

Display messages	Possible causes/consequences and ► Solutions
	<p>The symbol flashes for a maximum of 5 seconds and in addition a warning tone sounds.</p> <p>Lane Keeping Assist warning</p> <p>You are crossing a detected outer lane marking without indicating.</p> <p>► Remain in lane, paying attention to road and traffic conditions.</p> <p>or</p> <p>► Indicate to change lane.</p>
	<p>The symbol flashes for about 3 seconds and in addition a warning tone sounds. The symbol is then hidden.</p> <p>Lane Keeping Assist is malfunctioning and deactivated. Possible causes:</p> <ul style="list-style-type: none"> <li>• the windscreen is dirty in the camera's field of vision</li> <li>• visibility is impaired due to heavy rain, snow or fog</li> <li>• there are no lane markings for a longer period</li> <li>• the lane markings are worn, dark or covered, e.g. by dirt or snow</li> <li>• the system electronics are faulty</li> </ul> <p>Lane Keeping Assist is automatically operational again when the causes mentioned above no longer apply.</p> <p>If the windscreen is dirty:</p> <p>► Pull over and stop the vehicle safely as soon as possible, paying attention to road and traffic conditions.</p> <p>► Secure the vehicle against rolling away (▷ page 138).</p> <p>► Clean the outside of the windscreen (▷ page 222).</p> <p>If the windscreen is clean and the causes listed above do not apply, then the electronics are malfunctioning.</p> <p>► Visit a qualified specialist workshop.</p>
	<p>The symbols flash for about 5 seconds. The symbols then both remain lit.</p> <p>The tyre pressure monitor is restarted (▷ page 254).</p>
	<p>The symbol lights up without the speed display.</p> <p>The limiter has been activated without a speed being entered or has been cancelled.</p> <p>► Set a limit speed .</p>

Display messages	Possible causes/consequences and ► Solutions
	<p>The symbol flashes for about 10 seconds and is then hidden. A warning tone also sounds.</p> <p>The limiter is malfunctioning and deactivated automatically.</p> <p>► Visit a qualified specialist workshop.</p>
	<p>The symbol lights up and the speed display flashes. A warning tone also sounds.</p> <p>The vehicle is exceeding the set limit speed.</p> <p>► If required, brake the vehicle paying attention to road and traffic conditions.</p>
	<p>The symbol flashes for about 10 seconds and is then hidden. A warning tone also sounds.</p> <p>In addition, the  door warning lamp and other warning lamps, e.g. , light up.</p> <p>The central vehicle electronics system and cruise control are malfunctioning.</p> <p>After the engine is switched off:</p> <ul style="list-style-type: none"> <li>• do not lock/unlock the doors using the remote control function of the key</li> <li>• you can no longer start the engine</li> </ul> <p>► Pull over and stop the vehicle safely as soon as possible, paying attention to road and traffic conditions. Do not continue driving under any circumstances.</p> <p>► Secure the vehicle against rolling away (▷ page 138).</p> <p>► Consult a qualified specialist workshop.</p>
	<p>The symbol lights up without the speed display.</p> <p>Cruise control has been activated without a speed being entered or has been cancelled.</p> <p>► Set a speed (▷ page 145).</p>

Display messages	Possible causes/consequences and ► Solutions
	<p>The symbol flashes for about 10 seconds and is then hidden. A warning tone also sounds.</p> <p>Cruise control is malfunctioning and deactivated automatically.</p> <p>► Visit a qualified specialist workshop.</p>
	<p>The outside temperature has fallen to 3 °C or lower. The symbol flashes for about 1 minute. The road surface may be icy.</p> <p>If the outside temperature falls to a level under -3 °C, the symbol does not flash but rather remains on continuously.</p> <p>► Observe the information on the outside temperature display (► page 155).</p> <p>► Adapt your driving style and speed to suit the weather conditions.</p>

**Display messages (on-board computer with colour display)**





**Introduction**





Display messages with graphic symbols are simplified in the Owner's Manual and may differ from the symbols in the display. The display shows high-priority messages in red. For certain display messages a warning tone also sounds.

Please respond in accordance with the display messages and follow the additional notes in this Owner's Manual.





You can use the **OK** button on the multifunction steering wheel to hide low-priority messages. The display messages are stored in the message memory and can be called up as for as long as the ignition remains switched on (► page 162). When the ignition is turned off, the message memory is deleted and no display messages are stored. The cause of a display message should be remedied as soon as possible.

High-priority display messages cannot be hidden. The multifunction display shows these messages continuously until the causes for the messages have been remedied.

Safety systems	
Display messages	Possible causes/consequences and ► Solutions
 Malfunction Visit workshop	<p>The restraint system is faulty.</p> <p><b>⚠ WARNING</b></p> <p>The airbags or belt tensioners may either be triggered unintentionally or, in the event of an accident, may not be triggered.</p> <p>This poses an increased risk of injury.</p> <ul style="list-style-type: none"> <li>► Drive on carefully.</li> <li>► Have the restraint system checked at a qualified specialist workshop immediately.</li> </ul> <p>For further information about the restraint system, see (▷ page 38).</p>
Electronics malfunction Stop See Owner's Manual	<p>In addition, the ,  and  warning lamps light up in the instrument cluster and a warning tone sounds.</p> <p>ABS (Anti-lock Braking System) and ESP® (Electronic Stability Program) are malfunctioning. This means that Crosswind Assist and hill start assist, for example, are also unavailable. Further driving systems could be switched off automatically.</p> <p><b>⚠ WARNING</b></p> <p>The brake system continues to function normally, but without the functions listed above. The front and rear wheels could therefore lock if you brake hard, for example.</p> <p>The steerability and braking characteristics may be severely affected. The braking distance in an emergency braking situation can increase.</p> <p>If ESP® is not operational, ESP® is unable to stabilise the vehicle.</p> <p>The danger of skidding and having an accident increases.</p> <ul style="list-style-type: none"> <li>► Pull over and stop the vehicle safely as soon as possible, paying attention to road and traffic conditions. Do not continue driving under any circumstances.</li> <li>► Secure the vehicle against rolling away (▷ page 138).</li> <li>► Consult a qualified specialist workshop.</li> </ul>
 Release parking brake	<p>You are driving with the parking brake applied.</p> <ul style="list-style-type: none"> <li>► Release the parking brake.</li> </ul>

Display messages	Possible causes/consequences and ► Solutions
<p>Brake force distribution inoperative Stop See Owner's Manual</p>	<p>In addition, the  warning lamp in the instrument cluster lights up and a warning tone sounds.</p> <p>EBD is malfunctioning. This means that ABS, ESP®, Crosswind Assist and hill start assist, for example, are also unavailable. Further driving systems could be switched off automatically.</p> <p> <b>WARNING</b></p> <p>The brake system continues to function normally, but without the functions listed above. The front and rear wheels could therefore lock if you brake hard, for example.</p> <p>The steerability and braking characteristics may be severely affected. The braking distance in an emergency braking situation can increase.</p> <p>If ESP® is not operational, ESP® is unable to stabilise the vehicle.</p> <p>The danger of skidding and having an accident increases.</p> <ul style="list-style-type: none"> <li>► Pull over and stop the vehicle safely as soon as possible, paying attention to road and traffic conditions. Do not continue driving under any circumstances.</li> <li>► Secure the vehicle against rolling away (▷ page 138).</li> <li>► Consult a qualified specialist workshop.</li> </ul>
<p> Check brake fluid level</p>	<p>There is insufficient brake fluid in the brake fluid reservoir.</p> <p> <b>WARNING</b></p> <p>The braking efficiency may be impaired.</p> <p>There is a risk of an accident.</p> <ul style="list-style-type: none"> <li>► Pull over and stop the vehicle safely as soon as possible, paying attention to road and traffic conditions. Do not continue driving under any circumstances.</li> <li>► Secure the vehicle against rolling away (▷ page 138).</li> <li>► Do not top up the brake fluid. This does not correct the malfunction.</li> <li>► Consult a qualified specialist workshop.</li> </ul>

Display messages	Possible causes/consequences and ► Solutions
 <p data-bbox="181 296 488 331">System inoperative</p>	<p data-bbox="521 233 1398 306">ABS is malfunctioning. This means that ESP<sup>®</sup>, Crosswind Assist and hill start assist, for example, are also unavailable.</p> <p data-bbox="521 317 1390 352">Further driving systems could be switched off automatically.</p> <p data-bbox="537 380 716 415"><b>⚠ WARNING</b></p> <p data-bbox="521 432 1398 541">The brake system continues to function normally, but without the functions listed above. The wheels could therefore lock if you brake hard, for example.</p> <p data-bbox="521 558 1398 667">The steerability and braking characteristics may be severely affected. The braking distance in an emergency braking situation can increase.</p> <p data-bbox="521 684 1344 751">If ESP<sup>®</sup> is not operational, ESP<sup>®</sup> is unable to stabilise the vehicle.</p> <p data-bbox="521 768 1344 804">The danger of skidding and having an accident increases.</p> <ul data-bbox="521 821 1105 898" style="list-style-type: none"> <li>► Drive on carefully.</li> <li>► Visit a qualified specialist workshop.</li> </ul> <p data-bbox="521 915 1398 982">If the ABS control unit is faulty, there is also a possibility that other systems may be unavailable.</p>

Display messages	Possible causes/consequences and ► Solutions
 <p>System inoperative</p>	<p>ESP® is not available due to a malfunction.</p> <p>This means that Crosswind Assist and hill start assist, for example, are also unavailable.</p> <p>Further driving systems could be switched off automatically.</p> <p> <b>WARNING</b></p> <p>The brake system continues to function normally, but without the functions listed above.</p> <p>The braking distance in an emergency braking situation can thus increase.</p> <p>The brake lamps may not be functioning and thus no longer working when braking.</p> <p>If ESP® is not operational, ESP® is unable to stabilise the vehicle.</p> <p>The danger of skidding and having an accident increases.</p> <ul style="list-style-type: none"> <li>► Pull over and stop the vehicle safely as soon as possible, paying attention to road and traffic conditions. Do not continue driving under any circumstances.</li> <li>► Secure the vehicle against rolling away (▷ page 138).</li> <li>► Check that the brake lamps are working.</li> </ul> <p>If the brake lamps are not working:</p> <ul style="list-style-type: none"> <li>► Consult a qualified specialist workshop.</li> </ul> <p>If the brake lamps are working:</p> <ul style="list-style-type: none"> <li>► Drive on carefully.</li> <li>► Visit a qualified specialist workshop.</li> </ul>
<p>Hill start assist inoperative</p>	<p>The  warning lamp also lights up in the instrument cluster.</p> <p>Hill start assist is malfunctioning. If you release the brake, your vehicle will not be held automatically when pulling away uphill and may roll away immediately.</p> <p>Further driving systems could be switched off automatically.</p> <p> <b>WARNING</b></p> <p>The brake system continues to function normally, but without the functions listed above.</p> <p>If ESP® is not operational, ESP® is unable to stabilise the vehicle.</p> <p>The danger of skidding and having an accident increases.</p> <ul style="list-style-type: none"> <li>► Drive on carefully.</li> <li>► Visit a qualified specialist workshop.</li> </ul>

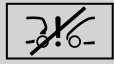
**Display messages**

**Distance warning inoperative**
**Possible causes/consequences and ► Solutions**

The distance warning function is temporarily inoperative.  
Possible causes:



- the smart logo in the radiator trim is dirty
- the function is impaired due to heavy rain or snow
- the radar sensor system is temporarily inoperative, e.g. due to electromagnetic radiation emitted by nearby TV or radio stations or other sources of electromagnetic radiation
- the system is outside the operating temperature range
- the on-board voltage is too low

Once the causes listed above no longer apply, the display message goes out.



The distance warning function is operational again.

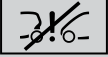

If the display message does not disappear:

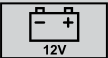

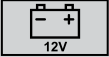

- Pull over and stop the vehicle safely as soon as possible, paying attention to road and traffic conditions.
- Secure the vehicle against rolling away (▷ page 138).
- Clean the smart logo in the radiator trim (▷ page 223).
- Restart the engine.





Display messages	Possible causes/consequences and ► Solutions
 <p>Electronics malfunction Visit workshop</p>	<p>The distance warning function is malfunctioning or temporarily inoperative. Possible causes:</p> <ul style="list-style-type: none"> <li>• the smart logo in the radiator trim is dirty</li> <li>• the function is impaired due to heavy rain or snow</li> <li>• the radar sensor system is temporarily inoperative, e.g. due to electromagnetic radiation emitted by nearby TV or radio stations or other sources of electromagnetic radiation</li> <li>• the system is outside the operating temperature range</li> <li>• the on-board voltage is too low</li> </ul> <p>If the causes listed above no longer apply, the distance warning function is operational again.</p> <p>If the display message continues to light up, the electronics of the distance warning function are malfunctioning.</p> <p>► Visit a qualified specialist workshop.</p>
 <p>Black ice warning</p>	<p>The outside temperature has fallen to 3 °C or lower. The road surface may be icy.</p> <p>If the outside temperature sinks below -3 °C, the colour display only shows the  symbol beside the outside temperature display.</p> <ul style="list-style-type: none"> <li>► Observe the information on the outside temperature display (▷ page 155).</li> <li>► Adapt your driving style and speed to suit the weather conditions.</li> </ul>

Engine	
Display messages	Possible causes/consequences and ► Solutions
 <p>Reduced power See Owner's Manual</p>	<p>The engine is running in emergency mode. For example, the fuel injection may be faulty.</p> <ul style="list-style-type: none"> <li>► Drive on carefully.</li> <li>► Visit a qualified specialist workshop immediately.</li> </ul>
 <p>Malfunction Visit workshop</p>	<p>The battery monitoring is malfunctioning.</p> <ul style="list-style-type: none"> <li>► Visit a qualified specialist workshop.</li> </ul>





Display messages	Possible causes/consequences and ► Solutions
 <p data-bbox="181 296 451 369">Stop See Owner's Manual</p>	<p data-bbox="521 233 997 264">The battery is not being charged.</p> <p data-bbox="521 279 756 310">Possible causes:</p> <ul data-bbox="521 331 1016 453" style="list-style-type: none"> <li>• faulty alternator</li> <li>• torn poly-V-belt</li> <li>• a malfunction in the electronics</li> </ul> <p data-bbox="521 474 1393 543">► Stop the vehicle immediately, paying attention to road and traffic conditions, and switch off the engine.</p> <p data-bbox="521 573 1393 642"><b>!</b> Do not continue driving. The engine could otherwise over-heat.</p> <p data-bbox="521 669 1300 701">► Secure the vehicle against rolling away (▷ page 138).</p> <p data-bbox="521 716 1133 747">► Consult a qualified specialist workshop.</p>
 <p data-bbox="181 846 440 919">Stop Switch off engine</p>	<p data-bbox="521 783 1393 814">The oil pressure is too low. There is a risk of engine damage.</p> <p data-bbox="521 835 1393 905">► Stop the vehicle immediately, paying attention to road and traffic conditions, and switch off the engine.</p> <p data-bbox="521 919 1300 951">► Secure the vehicle against rolling away (▷ page 138).</p> <p data-bbox="521 966 1008 997">► Check the oil level (▷ page 214).</p> <p data-bbox="521 1012 1227 1043">► If necessary, top up the engine oil (▷ page 215).</p> <p data-bbox="521 1064 1393 1134">Information on approved engine oils can also be obtained from any qualified specialist workshop.</p>



Display messages	Possible causes/consequences and ► Solutions
 <p>Stop Switch off engine</p>	<p>The coolant temperature has exceeded 110 °C. The airflow to the engine radiator may be blocked or the coolant level may be too low.</p> <p> <b>WARNING</b></p> <p>The engine is not being cooled sufficiently and may be damaged.</p> <p>Never drive with an overheated engine. Driving when your engine is overheated can cause some fluids which may have leaked into the engine compartment to catch fire.</p> <p>Steam from an overheated engine can cause serious burns, which can occur just by opening the engine compartment cover. There is a risk of injury.</p> <ul style="list-style-type: none"> <li>► Stop the vehicle immediately, paying attention to road and traffic conditions, and switch off the engine.</li> <li>► Secure the vehicle against rolling away (▷ page 138).</li> <li>► Leave the vehicle and keep a safe distance from the vehicle until the engine has cooled down.</li> <li>► Check the coolant level and top up the coolant. Observe the notes as you do so (▷ page 272).</li> <li>► If you have to top up the coolant frequently, have the engine cooling system checked.</li> <li>► Make sure that the air supply to the engine radiator is not blocked, e.g. by frozen slush.</li> <li>► Do not start the engine again until the coolant temperature is below 110 °C. The engine may otherwise be damaged.</li> </ul> <p>Avoid heavy loads on the engine as you do so, e.g. driving in mountainous terrain and stop-start traffic.</p>
 <p>Low fuel level</p>	<p>The fuel level has dropped into the reserve range.</p> <ul style="list-style-type: none"> <li>► Refuel at the nearest filling station.</li> </ul>







Driving systems	
Display messages	Possible causes/consequences and ► Solutions
 <p>Lane Keeping Assist inoperative</p>	<p>The  symbol in the top bar of the display also flashes white for approximately 3 seconds and a warning tone sounds. The symbol is then hidden.</p> <p>Lane Keeping Assist is malfunctioning and deactivated. Possible causes:</p> <ul style="list-style-type: none"> <li>• the windscreen is dirty in the camera's field of vision</li> <li>• visibility is impaired due to heavy rain, snow or fog</li> <li>• there are no lane markings for a longer period</li> <li>• the lane markings are worn, dark or covered, e.g. by dirt or snow</li> <li>• the system electronics are faulty</li> </ul> <p>Lane Keeping Assist is automatically operational again when the causes mentioned above no longer apply.</p> <p>If the windscreen is dirty:</p> <ul style="list-style-type: none"> <li>► Pull over and stop the vehicle safely as soon as possible, paying attention to road and traffic conditions.</li> <li>► Secure the vehicle against rolling away (▷ page 138).</li> <li>► Clean the outside of the windscreen (▷ page 222).</li> </ul> <p>If the windscreen is clean and the causes listed above do not apply, then the electronics are malfunctioning.</p> <ul style="list-style-type: none"> <li>► Visit a qualified specialist workshop.</li> </ul>
	<p>The symbol in the top bar of the display flashes green for a maximum of 5 seconds and a warning tone sounds.</p> <p>Lane Keeping Assist warning</p> <p>You are crossing a detected outer lane marking without indicating.</p> <ul style="list-style-type: none"> <li>► Remain in lane, paying attention to road and traffic conditions.</li> </ul> <p>or</p> <ul style="list-style-type: none"> <li>► Indicate to change lane.</li> </ul> <p>For further information about Lane Keeping Assist, see (▷ page 151).</p>
 <p>Limiter inoperative</p>	<p>The  symbol in the display footer also flashes for approximately 10 seconds and a warning tone sounds. The symbol is then hidden.</p> <p>The limiter is malfunctioning and deactivated automatically.</p> <ul style="list-style-type: none"> <li>► Visit a qualified specialist workshop.</li> </ul>





Display messages	Possible causes/consequences and ► Solutions
	<p>The symbol in the footer of the display is lit and the speed display flashes. A warning tone also sounds.</p> <p>The vehicle is exceeding the set limit speed.</p> <p>► If required, brake the vehicle, paying attention to road and traffic conditions.</p>
	<p>The symbol in the footer of the display is lit without a speed display.</p> <p>The limiter has been activated without a speed being entered or has been cancelled.</p> <p>► Set a limit speed .</p>
 <p>Cruise control inoperative</p>	<p>The  symbol in the display footer also flashes for approximately 10 seconds and a warning tone sounds. The symbol is then hidden.</p> <p>Cruise control is malfunctioning and deactivated automatically.</p> <p>► Visit a qualified specialist workshop.</p>
	<p>The symbol in the footer of the display is lit without a speed display.</p> <p>Cruise control has been activated without a speed being entered or has been cancelled.</p> <p>► Set a speed (▷ page 145).</p>











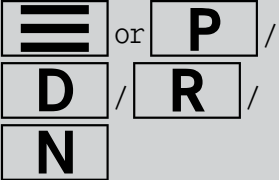

Tyres	
Display messages	Possible causes/consequences and ► Solutions
 <p>Tyre pressure Caution tyre malfunction</p>	<p>The tyre pressure in one or more tyres has dropped suddenly.</p> <p> <b>WARNING</b></p> <p>If you drive with a flat tyre, there is a risk of the following hazards:</p> <ul style="list-style-type: none"> <li>• a flat tyre affects the ability to steer or brake the vehicle</li> <li>• you could lose control of the vehicle</li> <li>• continued driving with a flat tyre will cause excessive heat build-up and possibly a fire</li> </ul> <p>There is a risk of an accident.</p> <p>► Stop the vehicle without making any sudden steering or braking manoeuvres. Pay attention to the traffic conditions as you do so.</p> <p>► Secure the vehicle against rolling away (▷ page 138).</p> <p>► Check the tyres and, if necessary, follow the instructions for a flat tyre (▷ page 229).</p>
 <p>Tyre pressure monitor inoperative</p>	<p>The tyre pressure monitor is malfunctioning or was not restarted after a wheel change.</p> <p> <b>WARNING</b></p> <p>The system is possibly unable to recognise or register low tyre pressure.</p> <p>There is a risk of an accident.</p> <p>► Restart the tyre pressure monitor after a wheel change (▷ page 254)</p> <p>The tyre pressure monitor is activated automatically after driving for a few minutes.</p> <p>If the display message continues to be displayed:</p> <ul style="list-style-type: none"> <li>► Drive on carefully.</li> <li>► Visit a qualified specialist workshop.</li> </ul>

Display messages	Possible causes/consequences and ► Solutions
 <p>Tyre pressure monitor inoperative wheel sensors missing</p>	<p>There is no signal from the tyre pressure sensor of one or several wheels, or the wheels fitted do not have suitable tyre pressure sensors. The tyre pressure monitor was not restarted after a wheel change.</p> <p> <b>WARNING</b></p> <p>The system is possibly unable to recognise or register low tyre pressure. There is a risk of an accident.</p> <ul style="list-style-type: none"> <li>► Have the faulty tyre pressure sensor replaced at a qualified specialist workshop.</li> </ul> <p>or</p> <ul style="list-style-type: none"> <li>► Fit wheels with suitable tyre pressure sensors.</li> </ul> <p>or</p> <ul style="list-style-type: none"> <li>► Restart the tyre pressure monitor after a wheel change (▷ page 254) The tyre pressure monitor is activated automatically after driving for a few minutes.</li> </ul> <p>If the display message continues to be displayed:</p> <ul style="list-style-type: none"> <li>► Drive on carefully.</li> <li>► Visit a qualified specialist workshop.</li> </ul>
 <p>Correct tyre pressure</p>	<p>The tyre pressure is too low in at least one of the tyres, or the tyre pressure difference between the wheels is too great.</p> <ul style="list-style-type: none"> <li>► Check the tyre pressures at the next opportunity (▷ page 253).</li> <li>► If necessary, correct the tyre pressure.</li> <li>► Restart the tyre pressure monitor (▷ page 254).</li> </ul>

Vehicle	
Display messages	Possible causes/consequences and ► Solutions
 Brake lamps inoperative	<p>The brake lights are not functioning. The actuation or the bulbs/LEDs are faulty.</p> <p> <b>WARNING</b></p> <p>Bulbs and lamps are an important aspect of vehicle safety. The brake lamps are not functioning and are no longer working when braking.</p> <p>There is a risk of an accident.</p> <ul style="list-style-type: none"> <li>► Pull over and stop the vehicle safely as soon as possible, paying attention to road and traffic conditions.</li> <li>► Secure the vehicle from rolling away (▷ page 138).</li> <li>► Consult a qualified specialist workshop.</li> </ul>
Switch off lights	<p>The lights are still switched on when you leave the vehicle. A warning tone also sounds.</p> <ul style="list-style-type: none"> <li>► Turn the light switch to <b>AUTO</b> or <b>0</b>.</li> </ul>
 (Example of all doors and tailgate open)	<p>A door or the tailgate is open. A warning tone also sounds. The display shows the open doors/tailgate.</p> <ul style="list-style-type: none"> <li>► Pull over, paying attention to road and traffic conditions, and stop the vehicle, then close the doors and tailgate.</li> </ul>
 Steering malfunction See Owner's Manual	<p>The power steering assistance is faulty.</p> <p> <b>WARNING</b></p> <p>You will need to use more force to steer.</p> <p>There is a risk of an accident.</p> <ul style="list-style-type: none"> <li>► Check whether you are able to apply the extra force required.</li> <li>► <b>If you are able to steer safely:</b> carefully drive on to a qualified specialist workshop.</li> <li>► <b>If you are unable to steer safely:</b> do not drive on. Contact the nearest qualified specialist workshop.</li> </ul>
 Electronics malfunction See Owner's Manual	<p>The power steering assistance may be malfunctioning. You may need to use more force to steer.</p> <ul style="list-style-type: none"> <li>► Drive on carefully to a qualified specialist workshop and have the steering checked immediately.</li> </ul>
 Malfunction See Owner's Manual	<p>The automatic Start/Stop function is malfunctioning and will be switched off.</p> <ul style="list-style-type: none"> <li>► Visit a qualified specialist workshop.</li> </ul>

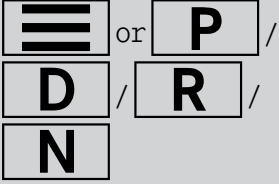
Display messages	Possible causes/consequences and ► Solutions
 <p>When exiting: remove key</p>	<p>The vehicle is in automatic engine stop. You have opened the driver's door or released the seat belt and the key is in the ignition lock.</p> <ul style="list-style-type: none"> <li>► The engine will not start automatically.</li> <li>► Please take note of the conditions for the automatic engine stop/engine start (▷ page 124).</li> </ul>
 <p>Depress clutch to start engine</p>	<p><b>Vehicles with manual transmission only:</b> you have stalled the engine when pulling away or when stopping.</p> <ul style="list-style-type: none"> <li>► Depress the clutch pedal fully. The engine starts automatically.</li> </ul>
 <p>Engage neutral to start engine</p>	<p><b>Vehicles with manual transmission only:</b> you have stalled the engine when pulling away or when stopping and the clutch sensor is inoperative.</p> <ul style="list-style-type: none"> <li>► Engage neutral (▷ page 127). The engine starts automatically.</li> </ul>
<p>To start engine: shift to neutral or depress clutch</p>	<p><b>Vehicles with manual transmission only:</b> you are trying to start the engine, a gear is engaged and the clutch pedal is not fully depressed.</p> <p>To start the engine:</p> <ul style="list-style-type: none"> <li>► Engage neutral. (▷ page 127)</li> </ul> <p>or</p> <ul style="list-style-type: none"> <li>► Depress the clutch pedal fully.</li> </ul>
<p>To start engine: shift to neutral</p>	<p><b>Vehicles with manual transmission only:</b> the clutch sensor is malfunctioning. You are trying to start the engine, a gear is engaged and the clutch pedal is fully depressed.</p> <ul style="list-style-type: none"> <li>► To start the engine, engage neutral. (▷ page 127)</li> <li>► Visit a qualified specialist workshop.</li> </ul>
 <p>Parking brake mal- function Apply parking brake to park</p>	<p><b>Only for vehicles with automatic transmission:</b> the letter <b>N</b> flashes in the middle of the display if you try to shift to <b>P</b>. A warning tone also sounds.</p> <p>The parking lock is malfunctioning.</p> <ul style="list-style-type: none"> <li>► Apply the parking brake to park.</li> </ul>

Display messages	Possible causes/consequences and ► Solutions
Shift to P or N to start	<p><b>Vehicles with automatic transmission only:</b> the currently selected transmission position is shown in the middle of the display.</p> <p>You have attempted to start the engine with the transmission in position <b>D</b> or <b>R</b>.</p> <p>► Shift to <b>P</b> or <b>N</b> to start.</p>
Shift to N to start	<p><b>Vehicles with automatic transmission only:</b> the currently selected transmission position is shown in the middle of the display.</p> <p>The engine switches off while the vehicle is in motion.</p> <p>► Shift to <b>N</b> to start.</p>
 <p>Apply brakes to start</p>	<p><b>Vehicles with automatic transmission only:</b> <b>N</b> is shown in the middle of the display.</p> <p>You have tried to start the engine in transmission position <b>N</b> without depressing the brake pedal.</p> <p>► Depress the brake pedal.</p>
Risk of vehicle rolling Transmission not in P	<p><b>Vehicles with automatic transmission only:</b> a warning tone also sounds.</p> <p>The driver's door is open/not fully closed and the gear lever is in position <b>R</b>, <b>N</b> or <b>D</b>.</p> <p> <b>WARNING</b></p> <p>The vehicle may roll away.</p> <p>There is a risk of an accident.</p> <p>► Shift the selector lever to position <b>P</b>.</p> <p>► Secure the vehicle to prevent it from rolling away.</p> <p>► Fully close the driver's door.</p>
 <p>Transmission malfunction Visit workshop</p>	<p><b>Vehicles with automatic transmission only:</b>  is shown.</p> <p>The automatic transmission is malfunctioning.</p> <p>► Consult a qualified specialist workshop.</p>
 <p>Clutch protection active See Owner's Manual</p>	<p><b>Vehicles with automatic transmission only:</b>  flashes alternately with the currently selected transmission position.</p> <p>The automatic transmission clutch has overheated. You will feel the clutch pedal pulsate.</p> <p>► Initially try to avoid pulling away or crawling manoeuvres. If the display message disappears, automatic transmission is available again.</p>



Display messages	Possible causes/consequences and ► Solutions
 <p>Transmission over-heated See Owner's Manual</p>	<p><b>Only for vehicles with automatic transmission:</b>  flashes alternately with the currently selected transmission position. A warning tone also sounds.</p> <p>Further pulling away or crawling manoeuvres have led to a critical clutch temperature.</p> <ul style="list-style-type: none"> <li>► Pull over and stop the vehicle safely as soon as possible, paying attention to road and traffic conditions.</li> <li>► Secure the vehicle to prevent it from rolling away.</li> <li>► Wait until the automatic transmission has cooled down and the display message does not reappear after acknowledging it.</li> </ul>
<p>Electronics malfunction Visit workshop</p>	<p>In addition, the  door warning lamp and other warning lamps, e.g. , light up.</p> <p>The central vehicle electronics system is malfunctioning. After the engine is switched off:</p> <ul style="list-style-type: none"> <li>• do not lock/unlock the doors using the remote control function of the key</li> <li>• you can no longer start the engine</li> <li>► Pull over and stop the vehicle safely as soon as possible, paying attention to road and traffic conditions. Do not continue driving under any circumstances.</li> <li>► Secure the vehicle against rolling away (▷ page 138).</li> <li>► Consult a qualified specialist workshop.</li> </ul>
<p>Electronics malfunction Visit workshop</p>	<p>The transmission electronics are malfunctioning or the idling sensor is faulty.</p> <p>The Start/Stop function and cruise control are deactivated automatically.</p> <p>Starting the engine is only possible with the clutch pedal fully depressed.</p> <ul style="list-style-type: none"> <li>► Visit a qualified specialist workshop.</li> </ul>
<p>Rain/light sensor inoperative</p>	<p>The rain/light sensor is malfunctioning.</p> <p>Automatic headlamp mode and automatic intermittent wipe are not available.</p> <ul style="list-style-type: none"> <li>► Switch on exterior lighting manually if required (▷ page 93).</li> <li>► Switch the windscreen wipers on or off manually as required (▷ page 101).</li> <li>► Visit a qualified specialist workshop.</li> </ul>









## Warning and indicator lamps in the instrument cluster

## Safety





## Seat belts







Problem	Possible causes/consequences and ► Solutions
 <p>Only for certain countries: the red seat belt warning lamp lights up for six seconds after the engine starts.</p>	<p>The seat belt warning lamp reminds the driver and front passenger to fasten their seat belts. An additional warning tone will sound if the driver's seat belt is not fastened.</p> <ul style="list-style-type: none"> <li>► Fasten your seat belt (▷ page 40). The warning tone ceases.</li> </ul>
 <p>After starting the engine, the red seat belt warning lamp lights up.</p>	<p>The driver or front passenger has not fastened their seat belt.</p> <ul style="list-style-type: none"> <li>► Fasten your seat belt (▷ page 40). The warning lamp goes out.</li> </ul>
 <p>The red seat belt warning lamp flashes and a warning tone sounds.</p>	<p>The driver or passenger has not fastened their seat belt. At the same time, you are driving faster than 20 km/h or have briefly driven faster than 20 km/h.</p> <ul style="list-style-type: none"> <li>► Fasten your seat belt (▷ page 40). The warning lamp goes out and the warning tone ceases.</li> </ul>

## Safety systems





Problem	Possible causes/consequences and ► Solutions
 <p>The red restraint system warning lamp is lit while the engine is running.</p>	<p>The restraint system is faulty.</p> <p> <b>WARNING</b></p> <p>The airbags or belt tensioners may either be triggered unintentionally or, in the event of an accident, may not be triggered.</p> <p>This poses an increased risk of injury.</p> <ul style="list-style-type: none"> <li>► Drive on carefully.</li> <li>► Have the restraint system checked at a qualified specialist workshop immediately.</li> </ul> <p>For further information about the restraint system, see (▷ page 38).</p>
   <p>The red brake system warning lamp, the yellow ESP<sup>®</sup> warning lamp and the yellow ABS warning lamp light up while the engine is running.</p>	<p>ABS (Anti-lock Braking System) and ESP<sup>®</sup> (Electronic Stability Program) are malfunctioning. This means that Crosswind Assist and hill start assist, for example, are also unavailable. Further driving systems could be switched off automatically.</p> <p> <b>WARNING</b></p> <p>The brake system continues to function normally, but without the functions listed above. The front and rear wheels could therefore lock if you brake hard, for example.</p> <p>The steerability and braking characteristics may be severely affected. The braking distance in an emergency braking situation can increase.</p> <p>If ESP<sup>®</sup> is not operational, ESP<sup>®</sup> is unable to stabilise the vehicle.</p> <p>The danger of skidding and having an accident increases.</p> <ul style="list-style-type: none"> <li>► Pull over and stop the vehicle safely as soon as possible, paying attention to road and traffic conditions. Do not continue driving under any circumstances.</li> <li>► Secure the vehicle against rolling away (▷ page 138).</li> <li>► Consult a qualified specialist workshop.</li> </ul>
 <p>The red brake system warning lamp comes on while the vehicle is moving. A warning tone also sounds.</p>	<p>You are driving with the parking brake applied.</p> <ul style="list-style-type: none"> <li>► Release the parking brake.</li> </ul> <p>The warning lamp goes out and the warning tone ceases.</p>





Problem	Possible causes/consequences and ► Solutions
<p></p> <p>The red brake system warning lamp comes on while the engine is running. A warning tone also sounds.</p>	<p>There is insufficient brake fluid in the brake fluid reservoir.</p> <p> <b>WARNING</b></p> <p>The braking efficiency may be impaired. There is a risk of an accident.</p> <ul style="list-style-type: none"> <li>► <b>Vehicles with a colour display:</b> observe the additional display messages.</li> <li>► Pull over and stop the vehicle safely as soon as possible, paying attention to road and traffic conditions. Do not continue driving under any circumstances.</li> <li>► Secure the vehicle against rolling away (▷ page 138).</li> <li>► Do not top up the brake fluid. Topping up will not rectify the fault.</li> <li>► Consult a qualified specialist workshop.</li> </ul>
<p></p> <p>The red brake system warning lamp comes on while the engine is running. A warning tone also sounds.</p>	<p>EBD (electronic brake force distribution) is malfunctioning. This means that ABS, ESP<sup>®</sup>, Crosswind Assist and hill start assist, for example, are also unavailable. Further driving systems could be switched off automatically.</p> <p> <b>WARNING</b></p> <p>The brake system continues to function normally, but without the functions listed above. The wheels could therefore lock early if you brake hard, for example. The steerability and braking characteristics may be severely affected. The braking distance in an emergency braking situation can increase. If ESP<sup>®</sup> is not operational, ESP<sup>®</sup> is unable to stabilise the vehicle. The danger of skidding and having an accident increases.</p> <ul style="list-style-type: none"> <li>► Pull over and stop the vehicle safely as soon as possible, paying attention to road and traffic conditions. Do not continue driving under any circumstances.</li> <li>► Secure the vehicle against rolling away (▷ page 138).</li> <li>► Consult a qualified specialist workshop.</li> </ul>





Problem	Possible causes/consequences and ► Solutions
 <p>The yellow ABS warning lamp is lit while the engine is running.</p>	<p>ABS is malfunctioning. This means that ESP<sup>®</sup>, Crosswind Assist and hill start assist, for example, are also unavailable. Further driving systems could be switched off automatically.</p> <p> <b>WARNING</b></p> <p>The brake system continues to function normally, but without the functions listed above. The wheels could therefore lock if you brake hard, for example.</p> <p>The steerability and braking characteristics may be severely affected. The braking distance in an emergency braking situation can increase.</p> <p>If ESP<sup>®</sup> is not operational, ESP<sup>®</sup> is unable to stabilise the vehicle.</p> <p>The danger of skidding and having an accident increases.</p> <ul style="list-style-type: none"> <li>► Drive on carefully.</li> <li>► Visit a qualified specialist workshop.</li> </ul> <p>If the ABS control unit is faulty, there is also a possibility that other systems may be unavailable.</p>
 <p>The yellow ESP<sup>®</sup> warning lamp is on when you are driving.</p> <p>In addition, the  door warning lamp and other warning lamps, e.g. , light up.</p>	<p>The central vehicle electronics system is malfunctioning.</p> <p>After the engine is switched off:</p> <ul style="list-style-type: none"> <li>• do not lock/unlock the doors using the remote control function of the key</li> <li>• you can no longer start the engine</li> </ul> <ul style="list-style-type: none"> <li>► <b>Vehicles with a colour display:</b> observe the additional display messages.</li> <li>► Pull over and stop the vehicle safely as soon as possible, paying attention to road and traffic conditions. Do not continue driving under any circumstances.</li> <li>► Secure the vehicle against rolling away (▷ page 138).</li> <li>► Consult a qualified specialist workshop.</li> </ul>
 <p>The yellow ESP<sup>®</sup> warning lamp flashes while the vehicle is in motion.</p>	<p>ESP<sup>®</sup> or traction control has intervened because there is a risk of skidding or at least one wheel has started to spin. Cruise control is automatically deactivated.</p> <ul style="list-style-type: none"> <li>► Only depress the accelerator pedal as far as necessary when pulling away.</li> <li>► Accelerate more gently while the vehicle is in motion.</li> <li>► Adapt your driving style to suit the road and weather conditions.</li> </ul>





Problem	Possible causes/consequences and ► Solutions
<p data-bbox="185 226 253 268"></p> <p data-bbox="185 281 496 394">The yellow ESP<sup>®</sup> warning lamp is lit while the engine is running.</p>	<p data-bbox="522 235 1130 268">ESP<sup>®</sup> is not available due to a malfunction.</p> <p data-bbox="522 281 1354 352">This means that Crosswind Assist and hill start assist, for example, are also unavailable.</p> <p data-bbox="522 365 1390 399">Further driving systems could be switched off automatically.</p> <p data-bbox="535 424 717 466"> <b>WARNING</b></p> <p data-bbox="522 478 1390 550">The brake system continues to function normally, but without the functions listed above.</p> <p data-bbox="522 562 1383 634">The braking distance in an emergency braking situation can thus increase.</p> <p data-bbox="522 646 1354 718">The brake lamps may not be functioning and thus no longer working when braking.</p> <p data-bbox="522 730 1344 802">If ESP<sup>®</sup> is not operational, ESP<sup>®</sup> is unable to stabilise the vehicle.</p> <p data-bbox="522 814 1344 848">The danger of skidding and having an accident increases.</p> <ul style="list-style-type: none"> <li data-bbox="522 861 1396 974">► Pull over and stop the vehicle safely as soon as possible, paying attention to road and traffic conditions. Do not continue driving under any circumstances.</li> <li data-bbox="522 987 1302 1020">► Secure the vehicle against rolling away (▷ page 138).</li> <li data-bbox="522 1033 1396 1104">► <b>Vehicles with a colour display:</b> observe the additional display messages.</li> <li data-bbox="522 1117 1117 1150">► Check that the brake lamps are working.</li> </ul> <p data-bbox="522 1176 1019 1209">If the brake lamps are not working:</p> <ul style="list-style-type: none"> <li data-bbox="522 1222 1133 1255">► Consult a qualified specialist workshop.</li> </ul> <p data-bbox="522 1281 967 1314">If the brake lamps are working:</p> <ul style="list-style-type: none"> <li data-bbox="522 1327 824 1360">► Drive on carefully.</li> <li data-bbox="522 1373 1101 1407">► Visit a qualified specialist workshop.</li> </ul>
<p data-bbox="185 1449 253 1491"></p> <p data-bbox="185 1503 496 1688">The yellow distance warning function warning lamp comes on while the vehicle is moving.</p> <p data-bbox="185 1701 496 1856">In addition, the  door warning lamp and other warning lamps, e.g. , light up.</p>	<p data-bbox="522 1457 1354 1491">The central vehicle electronics system is malfunctioning.</p> <p data-bbox="522 1503 987 1537">After the engine is switched off:</p> <ul style="list-style-type: none"> <li data-bbox="522 1549 1396 1621">• do not lock/unlock the doors using the remote control function of the key</li> <li data-bbox="522 1633 1036 1667">• you can no longer start the engine</li> </ul> <ul style="list-style-type: none"> <li data-bbox="522 1680 1396 1793">► Pull over and stop the vehicle safely as soon as possible, paying attention to road and traffic conditions. Do not continue driving under any circumstances.</li> <li data-bbox="522 1806 1302 1839">► Secure the vehicle against rolling away (▷ page 138).</li> <li data-bbox="522 1852 1133 1885">► Consult a qualified specialist workshop.</li> </ul>





Problem	Possible causes/consequences and ► Solutions
 <p>The yellow distance warning function warning lamp comes on while the vehicle is moving.</p>	<p>The distance warning function is malfunctioning or temporarily inoperative. Possible causes:</p> <ul style="list-style-type: none"> <li>• the smart logo in the radiator trim is dirty</li> <li>• the function is impaired due to heavy rain or snow</li> <li>• the radar sensor system is temporarily inoperative, e.g. due to electromagnetic radiation emitted by nearby TV or radio stations or other sources of electromagnetic radiation</li> <li>• the system is outside the operating temperature range</li> <li>• the on-board voltage is too low</li> </ul> <p>If the causes listed above no longer apply, the distance warning function is operational again.</p> <p>If the distance warning lamp continues to light up, the distance warning function electronics are malfunctioning.</p> <p>► Visit a qualified specialist workshop.</p>
 <p>The red distance warning lamp lights up while the vehicle is in motion. A warning tone also sounds.</p>	<p>You are approaching a vehicle or a stationary obstacle in your line of travel at too high a speed.</p> <ul style="list-style-type: none"> <li>► Be prepared to brake immediately.</li> <li>► Pay careful attention to the traffic situation. You may have to brake or take evasive action.</li> </ul> <p>Further information on the distance warning function (▷ page 62).</p>
 <p>The red distance warning lamp lights up while the vehicle is in motion.</p>	<p>The distance to the vehicle in front is too small for the speed selected.</p> <ul style="list-style-type: none"> <li>► Increase the distance.</li> </ul>





Engine	
Problem	Possible causes/consequences and ► Solutions
 <p>The yellow engine diagnostics warning lamp flashes while the engine is running.</p>	<p>The ignition system is malfunctioning. The engine is misfiring, for example, which means the catalytic converter could become damaged.</p> <p>► Visit a qualified specialist workshop immediately.</p>
 <p>The yellow engine diagnostics warning lamp lights up while the engine is running. The engine power output is also reduced.</p>	<p>The engine is running in emergency mode. This may lead to a malfunctioning of the fuel injection system, for example.</p> <p>► Drive on carefully.</p> <p>► Visit a qualified specialist workshop immediately.</p>
 <p>The yellow engine diagnostics warning lamp lights up while the engine is running.</p>	<p>There may be a fault, for example:</p> <ul style="list-style-type: none"> <li>• in the engine management</li> <li>• in the exhaust system</li> <li>• in the fuel system</li> <li>• with the accelerator pedal sensor</li> </ul> <p>► Visit a qualified specialist workshop immediately.</p>
 <p>The red battery warning lamp is lit while the engine is running. A warning tone also sounds.</p>	<p>The battery is not being charged.</p> <p>Possible causes:</p> <ul style="list-style-type: none"> <li>• faulty alternator</li> <li>• the battery is faulty</li> <li>• torn poly-V-belt</li> <li>• a malfunction in the electronics</li> </ul> <p>► Stop the vehicle immediately, paying attention to road and traffic conditions, and switch off the engine.</p> <p><b>!</b> Do not continue driving. The engine could otherwise overheat.</p> <p>► Secure the vehicle against rolling away (▷ page 138).</p> <p>► Consult a qualified specialist workshop.</p>





Problem	Possible causes/consequences and ► Solutions
 <p>The red oil pressure indicator lamp is lit while the engine is running. A warning tone also sounds.</p>	<p>The engine oil pressure is too low. There is a risk of engine damage.</p> <ul style="list-style-type: none"> <li>► Pull over and stop the vehicle safely as soon as possible, paying attention to road and traffic conditions. Do not continue driving under any circumstances.</li> <li>► Switch off the engine.</li> <li>► Secure the vehicle against rolling away (▷ page 138).</li> <li>► Check the oil level (▷ page 214).</li> <li>► If necessary, top up the engine oil (▷ page 215).</li> </ul> <p>Information on approved engine oils can also be obtained from any qualified specialist workshop.</p>
 <p>The red coolant temperature warning lamp comes on while the engine is running. A warning tone also sounds.</p>	<p>The coolant temperature has exceeded 110 °C. The airflow to the engine radiator may be blocked or the coolant level may be too low.</p> <p> <b>WARNING</b></p> <p>The engine is not being cooled sufficiently and may be damaged.</p> <p>Never drive with an overheated engine. Driving when your engine is overheated can cause some fluids which may have leaked into the engine compartment to catch fire.</p> <p>Steam from an overheated engine can cause serious burns, which can occur just by opening the engine compartment cover. There is a risk of injury.</p> <ul style="list-style-type: none"> <li>► Pull over and stop the vehicle safely as soon as possible, paying attention to road and traffic conditions. Do not continue driving under any circumstances.</li> <li>► Switch off the engine.</li> <li>► Secure the vehicle against rolling away (▷ page 138).</li> <li>► Leave the vehicle and keep a safe distance from the vehicle until the engine has cooled down.</li> <li>► Check the coolant level and top up the coolant. Observe the notes as you do so (▷ page 272).</li> <li>► If you have to top up the coolant frequently, have the engine cooling system checked.</li> <li>► Make sure that the air supply to the engine radiator is not blocked, e.g. by frozen slush.</li> <li>► Do not start the engine again until the coolant temperature is below 110 °C. The engine may otherwise be damaged.</li> </ul> <p>Avoid heavy loads on the engine as you do so, e.g. driving in mountainous terrain and stop-start traffic.</p>







Tyres	
Problem	Possible causes/consequences and ► Solutions
 You are driving and the yellow tyre pressure monitor warning lamp (pressure loss/malfunction) is lit. In addition, the  door warning lamp and other warning lamps, e.g.  , light up.	The central vehicle electronics system is malfunctioning. After the engine is switched off: <ul style="list-style-type: none"> <li>• do not lock/unlock the doors using the remote control function of the key</li> <li>• you can no longer start the engine</li> </ul> ► <b>Vehicles with a colour display:</b> observe the additional display messages. ► Pull over and stop the vehicle safely as soon as possible, paying attention to road and traffic conditions. Do not continue driving under any circumstances. ► Secure the vehicle against rolling away (▷ page 138). ► Consult a qualified specialist workshop.
 You are driving and the yellow tyre pressure monitor warning lamp (pressure loss/malfunction) is lit. A warning tone also sounds.	The tyre pressure in one or more tyres has dropped suddenly. <p> <b>WARNING</b></p> If you drive with a flat tyre, there is a risk of the following hazards: <ul style="list-style-type: none"> <li>• a flat tyre affects the ability to steer or brake the vehicle</li> <li>• you could lose control of the vehicle</li> <li>• continued driving with a flat tyre will cause excessive heat build-up and possibly a fire</li> </ul> There is a risk of an accident. <ul style="list-style-type: none"> <li>► Stop the vehicle without making any sudden steering or braking manoeuvres. Pay attention to the traffic conditions as you do so.</li> <li>► Secure the vehicle against rolling away (▷ page 138).</li> <li>► Check the tyres and, if necessary, follow the instructions for a flat tyre (▷ page 229).</li> </ul>

Problem	Possible causes/consequences and ► Solutions
<p></p> <p>The yellow tyre pressure monitor warning lamp (pressure loss/malfunction) flashes for approximately 1 minute and then remains lit.</p>	<p>There is no signal from the tyre pressure sensor of one or several wheels, or the wheels fitted do not have suitable tyre pressure sensors. The tyre pressure monitor was not restarted after a wheel change.</p> <p> <b>WARNING</b></p> <p>The system is possibly unable to recognise or register low tyre pressure. There is a risk of an accident.</p> <p>► <b>Vehicles with a colour display:</b> observe the additional display messages.</p> <p>► Have the faulty tyre pressure sensor replaced at a qualified specialist workshop.</p> <p>or</p> <p>► Fit wheels with suitable tyre pressure sensors.</p> <p>or</p> <p>► Restart the tyre pressure monitor after a wheel change (▷ page 254). The tyre pressure monitor is activated automatically after driving for a few minutes.</p> <p>If the yellow tyre pressure monitor warning lamp continues to remain on:</p> <p>► Drive on carefully.</p> <p>► Visit a qualified specialist workshop.</p>
<p></p> <p>You are driving and the yellow tyre pressure monitor warning lamp (pressure loss/malfunction) is lit.</p>	<p>The tyre pressure is too low in at least one of the tyres, or the tyre pressure difference between the wheels is too great.</p> <p>► Check the tyre pressures at the next opportunity (▷ page 253).</p> <p>► If necessary, correct the tyre pressure.</p> <p>► Restart the tyre pressure monitor (▷ page 254).</p>



Vehicle	
Problem	Possible causes/consequences and ► Solutions
 <p>The red door warning lamp comes on while the vehicle is moving. In addition, further warning lamps light up, such as .</p>	<p>The central vehicle electronics system is malfunctioning. After the engine is switched off:</p> <ul style="list-style-type: none"> <li>• do not lock/unlock the doors using the remote control function of the key</li> <li>• you can no longer start the engine</li> </ul> <p>► <b>Vehicles with a colour display:</b> observe the additional display messages.</p> <p>► Pull over and stop the vehicle safely as soon as possible, paying attention to road and traffic conditions. Do not continue driving under any circumstances.</p> <p>► Secure the vehicle against rolling away (▷ page 138).</p> <p>► Consult a qualified specialist workshop.</p>
 <p>The red door warning lamp is on.</p>	<p>A door or the tailgate is open. If you are driving at speeds above 20 km/h, an additional warning tone will sound.</p> <p>► <b>Vehicles with a colour display:</b> observe the additional display messages.</p> <p>► Pull over at a suitable place and stop the vehicle safely, paying attention to road and traffic conditions.</p> <p>► Secure the vehicle against rolling away (▷ page 138).</p> <p>► Close all doors and the tailgate.</p>
 <p>The yellow power steering warning lamp is lit while the engine is running.</p>	<p>The power steering assistance is faulty.</p> <p> <b>WARNING</b></p> <p>You may need to use more force to steer. There is a risk of an accident.</p> <p>► <b>Vehicles with a colour display:</b> observe the additional display messages.</p> <p>► Check whether you are able to apply the extra force required.</p> <p>► <b>If you are able to steer safely:</b> carefully drive on to a qualified specialist workshop.</p> <p>► <b>If you are unable to steer safely:</b> do not drive on. Contact the nearest qualified specialist workshop.</p>

Problem	Possible causes/consequences and ► Solutions
 The yellow automatic Start/Stop function warning lamp is lit when the vehicle is stationary and while it is moving.	The automatic Start/Stop function is malfunctioning and will be switched off. ► Visit a qualified specialist workshop.
 The yellow automatic Start/Stop function warning lamp only lights up when the vehicle is stationary.	Not all conditions for the automatic engine switch-off have been met. ► Please take note of the conditions for automatic engine switch-off (► page 124).
 The green automatic Start/Stop system indicator lamp starts flashing when the vehicle is stationary and the engine is running.	<p><b>Vehicles with manual transmission only:</b> the vehicle is at a standstill. No stop preventers are active. The clutch pedal is fully depressed.</p> <p>The engine is not switched off automatically. The flashing indicator lamp is intended to remind you to activate the start/stop function in order to save fuel.</p> ► Shift to neutral and slowly release the clutch pedal. (► page 127). The engine is switched off automatically.
 The green automatic Start/Stop function indicator lamp flashes during the automatic engine switch-off. A warning tone also sounds.	<p>The vehicle is in automatic engine stop. The driver's door has been opened or the seatbelt removed while the ignition is switched on.</p> <p>The engine will not start automatically.</p> ► <b>Vehicles with manual transmission:</b> depress the clutch pedal completely. <b>Vehicles with automatic transmission:</b> release the brake. The engine starts automatically.
 The green automatic Start/Stop system indicator lamp starts flashing and the engine is switched off.	<p><b>Vehicles with manual transmission only:</b> you have stalled the engine when pulling away or when stopping.</p> ► Depress the clutch pedal fully. The engine starts automatically. <p>If the engine does not start automatically:</p> ► Engage neutral (► page 127). The engine starts automatically.



Useful information ..... 204  
Stowage areas ..... 204  
Features ..... 209

>> Stowing and features.



### Useful information

- i** This Owner's Manual describes all models, series and optional equipment for your vehicle that were available at the time of going to press. Country-specific differences are possible. Note that your vehicle may not be fitted with all features described. This is also the case for systems and functions relevant to safety.
- i** Read the information on qualified specialist workshops: (▷ page 21).

### Stowage areas

#### Loading guidelines

##### **WARNING**

If objects, luggage or loads are not secured or not secured sufficiently, they could slip, tip over or be flung around and thereby hit vehicle occupants. There is a risk of injury, especially when braking or abruptly changing directions.

Always store objects so that they cannot be flung around. Secure objects, luggage or loads against slipping or tipping before the journey.

##### **WARNING**

Combustion engines emit poisonous exhaust gases such as carbon monoxide. If the tailgate is open when the engine is running, particularly if the vehicle is moving, exhaust fumes could enter the passenger compartment. There is a risk of poisoning.

Turn off the engine before opening the tailgate. Never drive with the tailgate open.

Your vehicle has not been approved by the manufacturer for towing a trailer. A trailer could seriously impair driving safety.

The handling characteristics of a laden vehicle are dependent on the distribution of the load within the vehicle. For this reason, you should observe the following notes when transporting a load:

- never exceed the maximum permissible gross vehicle weight or the permissible axle loads for the vehicle (including occupants)
- the luggage compartment is the preferred place to carry objects
- stow heavy loads as far forwards and as low down in the load compartment as possible.
- the load must not protrude above the upper edge of the seat backrests
- always place the load against the rear or front seat backrests. Make sure that the seat backrests are securely locked into place
- always place the load behind unoccupied seats if possible
- use the lashing eyelets to transport loads and luggage
- only use lashing eyelets and fastening components that are suitable for the weight and size of the load
- stow objects in the ruffled pockets behind the front seats

### Stowage compartments

#### Important safety notes

##### **WARNING**

If you stow objects in the vehicle interior in an unsuitable way, they could slip or be thrown around and thus hit vehicle occupants. There is a risk of injury, especially in the case of heavy braking or a sudden change in direction.

- Always stow objects so they cannot be thrown around in these or similar situations.
- Always ensure that objects do not protrude over the top of stowage compartments or ruffled pockets.
- Close closable stowage compartments while driving.
- Always stow and secure heavy, hard, pointed, sharp-edged or fragile objects behind the last bench seat or under the passenger seats.

Observe the loading guidelines (▷ page 204).

### Glove compartment



Illustration of a closed glove compartment

► **To open:** pull handle ①.

The closed glove compartment can be locked with the key.

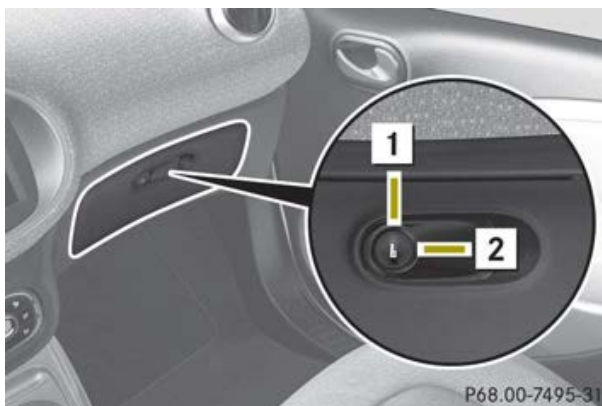

- **To lock:** insert the key into the lock and turn it 90° clockwise to position ②.
- **To unlock:** insert the key into the lock and turn it 90° anti-clockwise to position ①.

### Stowage compartment in the doors

The stowage compartments are located in the front and rear doors.



Stowage compartment in the driver's door

① Stowage compartment

Bottles can be stowed in the doors.

### Drawer in the centre console

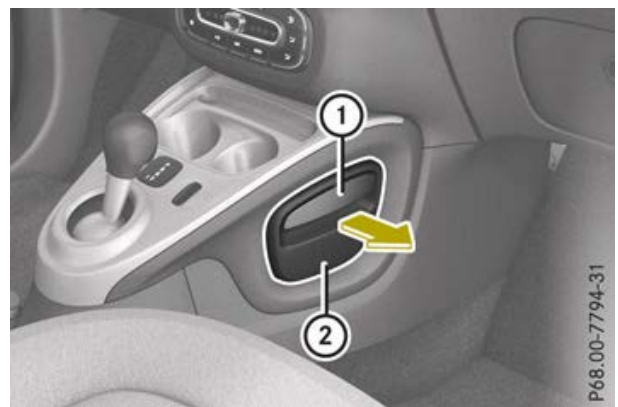

► Pull drawer ② by handle ① in the direction of the arrow.



### Rear stowage compartment (vehicles with readyspace seats)

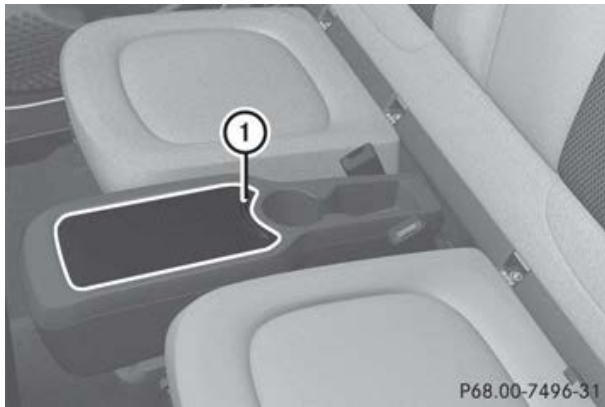

- ▶ **To open:** pull the cover forward from handle strip ①.

### Enlarging the luggage compartment

#### Important safety notes

#### ⚠ WARNING

If the rear bench seat/rear seat and seat backrest are not engaged they could fold forwards, e.g. when braking suddenly or in the event of an accident.

- The vehicle occupant would thereby be pushed into the seat belt by the rear bench seat/rear seat or by the seat backrest. The seat belt cannot protect as intended and could result in additional injury.
- Objects or loads in the boot/luggage compartment cannot be restrained by the seat backrest.

This poses an increased risk of injury.

Before every trip, make sure that the seat backrests and the rear bench seat/rear seat are engaged before every trip.

Observe the loading guidelines (▷ page 204).

The left-hand and right-hand rear seat backrests, or the entire back row, depending on vehicle equipment, can be folded forwards to increase the luggage compartment capacity.

### Folding the rear seat backrest forward

- ⚠ Vehicles with readyspace seats: if you fold the rear backrests forwards, ensure that the rear seat cushions are not rotated. Otherwise, the backrests may be damaged.

- ▶ Fully insert the backrest head restraints (▷ page 87).

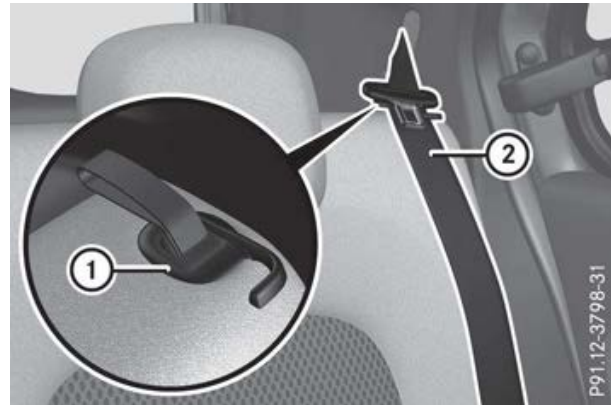

- ▶ Insert seat belt ② into seat-belt holder ①.

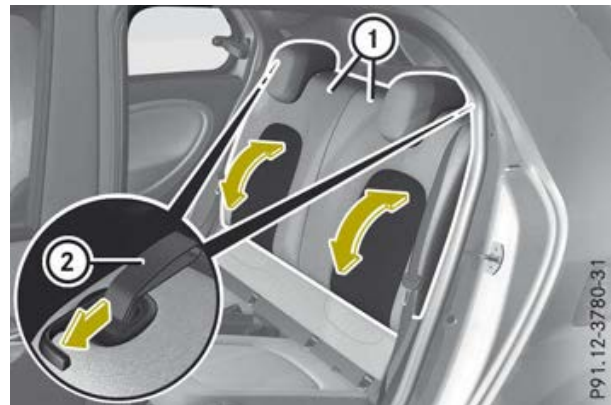

- ▶ **Vehicles with one-piece rear bench seat:** pull left and right loop ② on the backrest at the same time in the direction of the arrow. Backrest ① is released.
- ▶ Fold down complete backrest ① fully.
- ▶ **Vehicles with split rear bench seat:** pull left and right loop ② on the backrest in the direction of the arrow. The corresponding seat backrest ① is released.
- ▶ Fold down corresponding backrest ① fully.

## Folding the rear seat backrest back

**!** Make sure that the seat belt does not become trapped when folding the rear seat backrest back. Otherwise, it could be damaged.

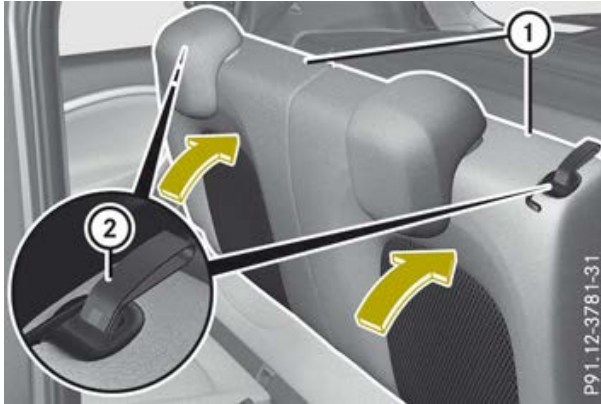

- ▶ **Vehicles with one-piece rear bench seat:** fold complete seat backrest ① back until it engages. Ensure that red lock status indicator ② on the loop is no longer visible.
- ▶ **Vehicles with split rear bench seat:** fold back left or right seat backrest ① until it engages. Ensure that red lock status indicator ② on the loop is no longer visible.
- ▶ Adjust the head restraints if necessary (▷ page 87).

## Adjusting the angle of the rear seat backrests (cargo position)



Vehicles with split rear bench seat: you can move the rear seat backrests to a more upright position (cargo position) to increase the luggage compartment capacity further.

- ▶ Release right-hand or left-hand seat backrest ② (▷ page 206).
- ▶ Fold right-hand or left-hand seat backrest ② slightly forwards.

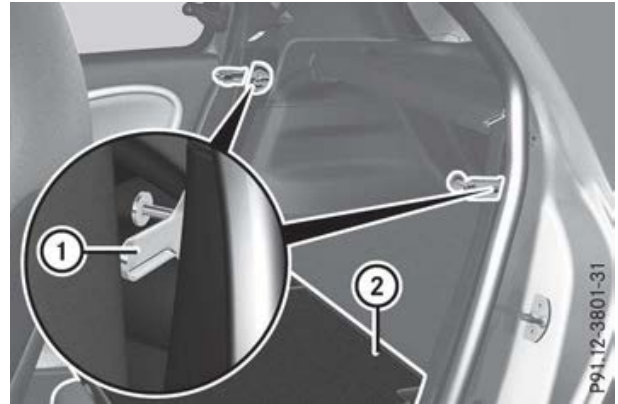

Illustration: seat backrest catch folded forwards

- ▶ Fold seat backrest catch ① forwards.
- ▶ Fold right-hand or left-hand seat backrest ① back to seat backrest catch ① until it locks. The cargo position has been set up.

## Readyspace seats

### General notes

You can rotate the rear seat cushions 180° and remove the cargo box. This will give you a flat loading surface and a larger load capacity in the rear.

### Rotating the seat cushions

#### **!** WARNING

If you rotate the rear seat cushion when the cargo box is removed, you or other vehicle occupants could be caught in the seat mechanism. There is a risk of injury.

Only rotate the seat cushion if the cargo box is fitted. Ensure that no parts of the

body are in the immediate vicinity of moving parts.

- ❗ Do not fold the rear seat backrests forwards if the rear seat cushions have been rotated. Otherwise, the rear seat backrests may be damaged.

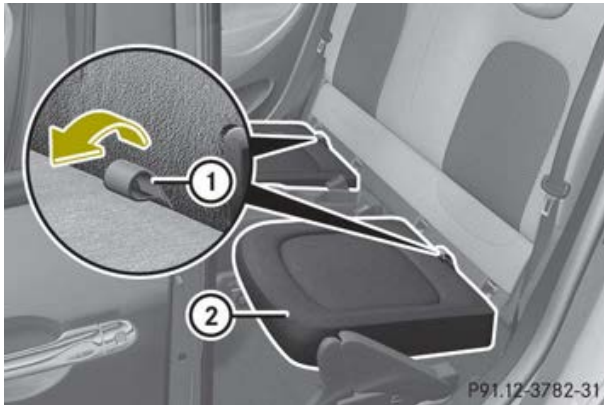

- ▶ Pull loop ① and rotate seat cushion ② 180°.

>> Stowing and features.

### Removing cargo box

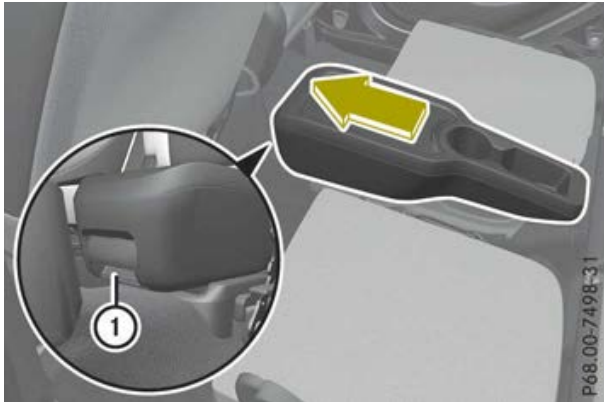

- ▶ Release the cargo box using release handle ①.
- ▶ Slide the cargo box forwards, in the direction of the arrow.
- ▶ Lift up and remove the cargo box.

### Parcel shelf

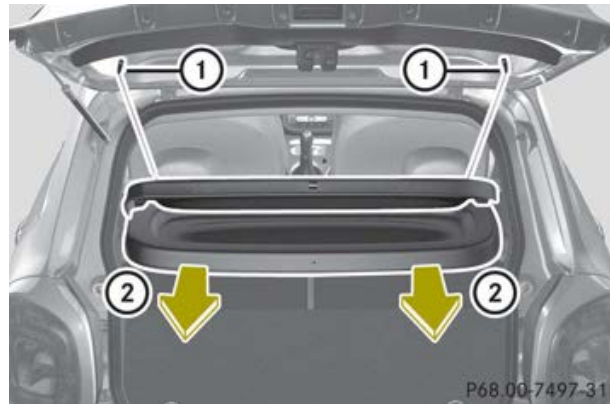

- ❗ The maximum load which may be placed on the parcel shelf is 3 kg.

- ▶ **To remove:** unhook straps ① from the tailgate.
- ▶ Fold the parcel shelf downwards.
- ▶ Pull the parcel shelf out to the rear ②.
- ▶ **To fit:** place the parcel shelf on the guide rails on the left and right.
- ▶ Push the parcel shelf evenly forwards using both hands until it engages.
- ▶ Fold the parcel shelf up.
- ▶ Hook straps ① to the tailgate.

### Lashing eyelets

Observe the following notes on securing loads:

- Observe the loading guidelines (▷ page 204).
- Secure the load using the lashing eyelets.
- Distribute the load on the lashing eyelets evenly.
- Do not use elastic straps or nets to secure a load, as these are only intended as an anti-slip protection for light loads.
- Do not route lashing materials across sharp edges or corners.
- Pad sharp edges for protection.

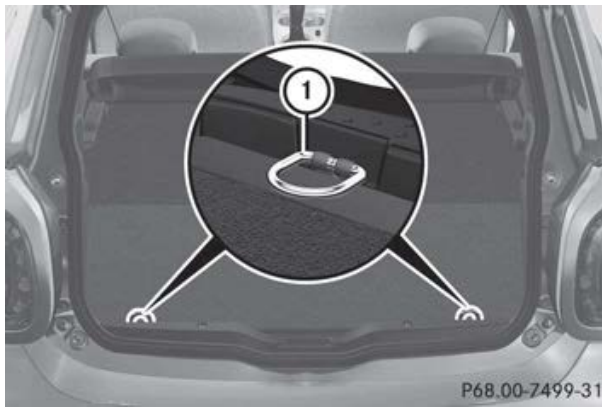

① Lashing eyelets

**Fitting/removing the subwoofer**

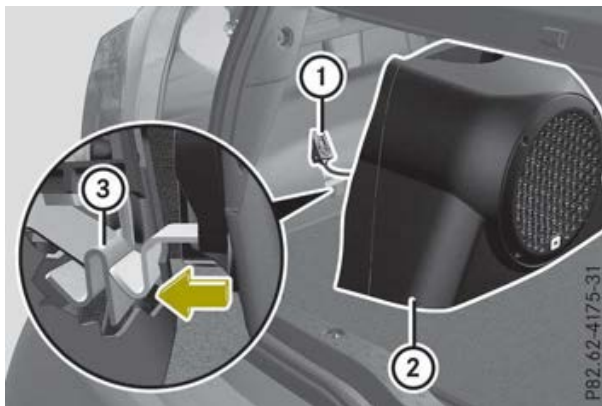

- ▶ **To fit:** insert connector ①.
- ▶ Place subwoofer ② on the side trim.
- ▶ Slide subwoofer ② to bracket ③.



- ▶ Slide the subwoofer up in the direction of the arrow on bracket ③.

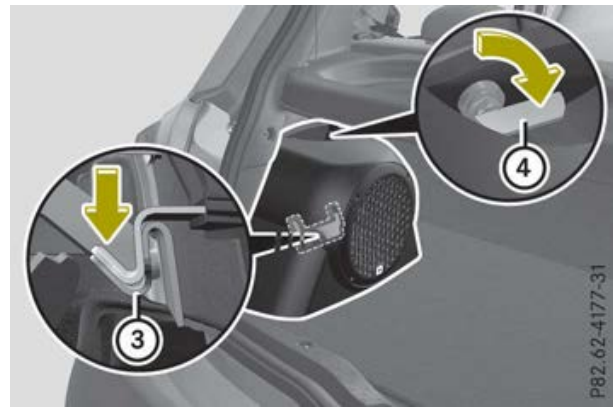

- ▶ Then slide the subwoofer over bracket ③ in the direction of the arrow until the subwoofer slides down.
- ▶ Close quick-release fastener ④.
- ▶ **To remove:** release quick-release fastener ④.
- ▶ Slide the subwoofer up over bracket ③ and remove.
- ▶ Disconnect plug ①.
- ▶ Take out subwoofer ①.

**Features**

**Cup holders**

**Important safety notes**

**⚠ WARNING**

The cup holder cannot secure a drinks container in place during a journey. If you use a cup holder during a journey, the drinks container could be flung around and liquid could be spilt. Vehicle occupants could come into contact with the liquid and, in particular, be scalded by hot liquid. You could be distracted from the traffic situation and lose control of the vehicle. There is a risk of an accident and injury.

Only use the cup holder when the vehicle is stationary. Only place containers of a suitable size in the cup holder. Seal the container, in particular when it contains hot liquid.

>> Stowing and features.

### WARNING

If you do not correctly store objects in the vehicle interior, they can slip or be flung around, thus striking vehicle occupants. There is a risk of injury, especially when braking or abruptly changing directions.

- Always store objects so that they cannot be flung around in these or in similar situations.
- Always make sure that objects do not protrude from stowage compartments, luggage nets or stowage nets.
- Close lockable stowage compartments while driving.
- Stow and secure objects that are heavy, hard, pointy, sharp-edged, fragile or too large in the luggage compartment.

**!** Only use the cup holders for containers of the right size and which have lids. The drinks could otherwise spill.

Observe the loading guidelines (▷ page 204).

### Cup holder in the front centre console



① Cup holders

### Cup holder in the centre console



① Cup holders

The cup holder has a recess for storing selected mobile phones.

### Cup holders in the rear compartment

Only available with readyspace seats.

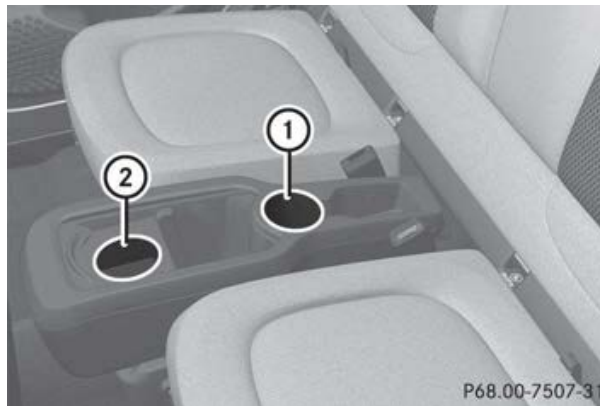

① Cup holders

② Cup holders

► To use cup holder ② open the stowage compartment.

Front cupholder ② can be removed. The maximum permissible load of the resulting stowage compartment is 1 kg

## Sun visors

### Overview

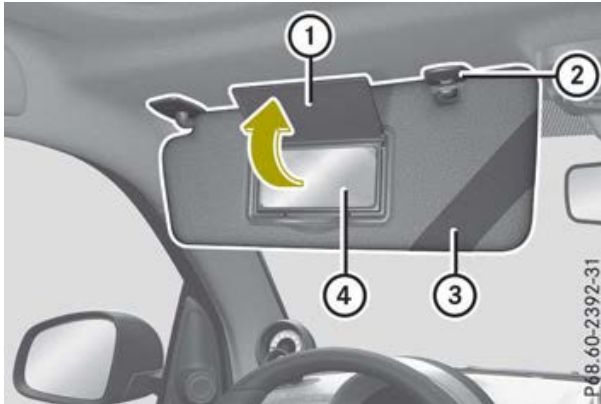

- ① Mirror cover
- ② Bracket
- ③ Retaining strap
- ④ Vanity mirror

### Glare from the side

- ▶ Fold down the sun visor.
- ▶ Pull the sun visor out of bracket ②.
- ▶ Swing the sun visor to the side.

## Ashtray

**!** The cup holder in the centre console is not heat resistant. Before placing lit cigarettes in the ashtray, make sure that the ashtray is fully inserted in the cup holder. Make sure that lit cigarettes do not fall into the cup holder.

Otherwise, the cup holder could be damaged.



- ▶ **To open:** lift up cover ①.
- ▶ **To close:** push down cover ①.
- ▶ **To remove:** pull the ashtray up and out.
- ▶ **To insert:** insert the ashtray into the cup holder.

**i** If you remove the ashtray, you can use the resulting compartment for stowage.

## Cigarette lighter

### Important safety notes

#### **⚠ WARNING**

You can burn yourself if you touch the hot heating element or the socket of the cigarette lighter.

In addition, flammable materials can ignite if:

- the hot cigarette lighter falls
- a child holds the hot cigarette lighter to objects, for example

There is a risk of fire and injury.

Always hold the cigarette lighter by the knob. Always make sure that the cigarette lighter is out of reach of children. Never leave children unattended in the vehicle.

Your attention must always be focused on the traffic conditions. Only use the cigarette lighter when road and traffic conditions permit.

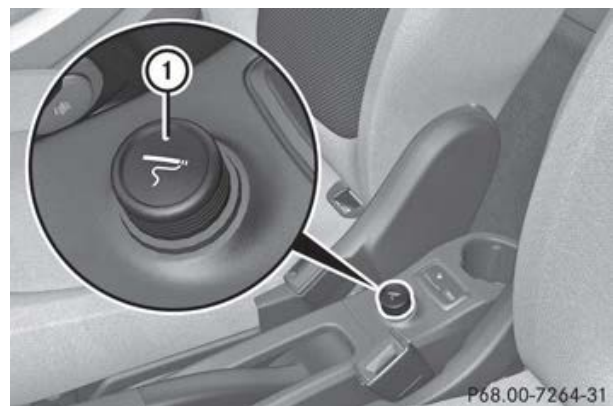

- ▶ Press in cigarette lighter ①.  
Cigarette lighter ① will pop out automatically when the heating element is red-hot.

### 12 V sockets

#### General notes

- ▶ Turn the key to position **1** in the ignition lock (▷ page 121).

The sockets can be used for accessories with a maximum draw of 120 W (10 A). Example accessories include mobile phone chargers.

If you use the sockets for long periods when the engine is switched off, the battery may discharge.

#### Socket in the front centre console

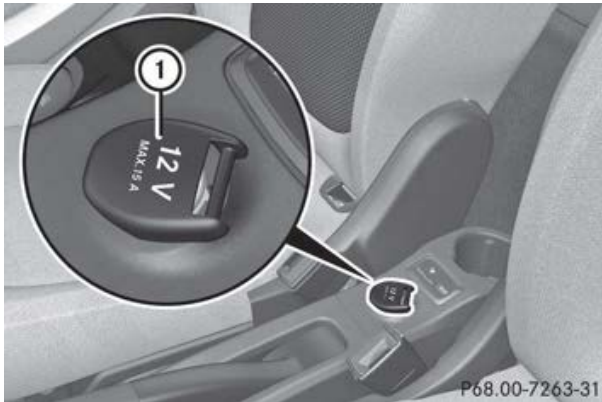

- ▶ Lift up the cover of socket ①.

#### Floormat on the driver's side

##### WARNING

Objects in the driver's footwell may restrict the clearance around the pedals or block a depressed pedal. This jeopardises the operating and road safety of the vehicle. There is a risk of an accident.

Stow all objects securely in the vehicle so that they do not get into the driver's footwell. Always fit the floormats securely and as prescribed in order to ensure that there

is always sufficient room for the pedals. Do not use loose floormats and do not place several floormats on top of one another.

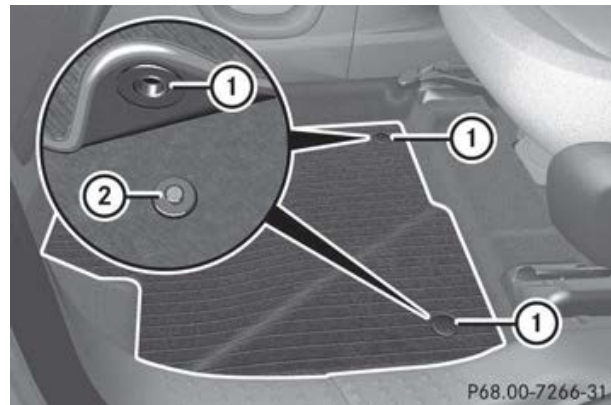

- ▶ Slide the driver's seat backwards.
- ▶ **To fit:** lay the floormat in the footwell.
- ▶ Press safety catch knobs ① onto retainers ②.
- ▶ **To remove:** pull the floormat from retainers ②.
- ▶ Remove the floormat.

Useful information .....	214
Checking service products .....	214
Service .....	218
Care .....	220

### Useful information

- i** This Owner's Manual describes all models, series and optional equipment for your vehicle that were available at the time of going to press. Country-specific differences are possible. Note that your vehicle may not be fitted with all features described. This is also the case for systems and functions relevant to safety.
- i** Read the information on qualified specialist workshops: (▷ page 21).

### Checking service products

#### Engine compartment (rear)

#### Engine compartment cover

#### WARNING

The engine compartment cover can become very hot. There is a risk of injury if you remove the engine compartment cover to work in the engine compartment.

Allow the engine to cool down before removing the engine compartment cover.

- ▶ **To open:** apply the parking brake.
- ▶ Select a gear.
- ▶ Switch the ignition off.
- ▶ Remove the key from the ignition lock.
- ▶ Open the tailgate (▷ page 75).
- ▶ For vehicles with the subwoofer: remove the subwoofer (▷ page 214).

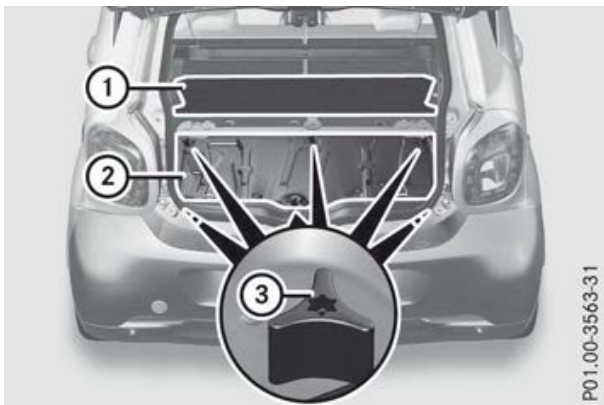

P01.00-3563-31

- ▶ Remove parcel shelf ① (▷ page 208) if necessary.
- ▶ Hold the carpet on the right and left sides and fold upwards.
- ▶ Remove the carpet from the vehicle.
- ▶ Unscrew screws ③ from engine compartment cover ② manually.
- ▶ Remove engine compartment cover ②.
- ▶ **To close:** slide engine compartment cover ② forward as far as it will go.
- ▶ Retighten screws ③ manually.
- ▶ Put the carpet back into the vehicle.
- ▶ Fold down the carpet and push it under the side panelling.
- ▶ For vehicles with the subwoofer: fit the subwoofer again (▷ page 214).
- ▶ Close the tailgate.

#### Engine oil

#### General notes

Depending on your driving style, the vehicle consumes up to 0.5 litres of oil per 1000 km. The oil consumption may be higher than this when the vehicle is new or if you frequently drive at high engine speeds.

When checking the oil level:

- park the vehicle on a level surface
- the engine should be switched off for approximately 5 minutes if the engine is at normal operating temperature
- if the engine is not at normal operating temperature, e.g. if the engine was only started briefly, wait approximately 30 minutes before carrying out the measurement

#### Checking the oil level using the oil dipstick

#### WARNING

Certain components in the engine compartment could be very hot, e.g. the engine, the radiator and parts of the exhaust system.

There is a risk of injury when accessing the engine compartment.

As far as possible, allow the engine to cool down and only touch the components described in the following.

**⚠ WARNING**

If you open the bonnet while the engine is overheating or while there is a fire in the engine compartment, you could come into contact with hot gases or other leaking service products. There is a danger of injury. Allow an overheating engine to cool down before opening the bonnet. If there is a fire in the engine compartment, leave the bonnet closed and notify the fire brigade.

**⚠ WARNING**

There are moving components in the engine compartment. Certain components may continue to move or suddenly move again even after the ignition has been switched off, e.g. the radiator fan. There is a risk of injury.

If you have to carry out work in the engine compartment:

- switch off the ignition
  - never touch the dangerous areas surrounding moving components, e.g. the rotation area of the fan
  - remove jewellery and watches
  - keep items of clothing and hair, for example, away from moving parts.
- Open the engine compartment cover (▷ page 214).

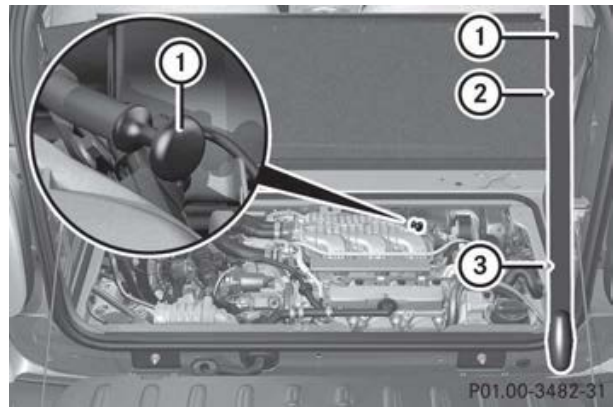

Example

- Pull oil dipstick ① out of the oil dipstick tube.
- Wipe off oil dipstick ①.
- Slowly slide oil dipstick ① into the guide tube to the stop, and take it out again.  
If the level is between MIN mark ③ and MAX mark ②, the oil level is correct.

### Adding engine oil

**⚠ WARNING**

Certain components in the engine compartment could be very hot, e.g. the engine, the radiator and parts of the exhaust system. There is a risk of injury when accessing the engine compartment.

As far as possible, allow the engine to cool down and only touch the components described in the following.

**⚠ WARNING**

If engine oil comes into contact with hot components in the engine compartment, it may ignite. There is a risk of fire and injury.

Make sure that engine oil does not spill out over the filler neck. Allow the engine to cool down and thoroughly clean the components that have come into contact with engine oil before you start the engine.

### 🌿 Environmental note

When topping up the oil, take care not to spill any. If oil enters the soil or waterways, it is harmful to the environment.

- ❗ Do not add too much oil. Topping up with too much engine oil can result in damage to the engine or to the catalytic converter. Have excess engine oil siphoned off.

You will find further information on engine oils you can use in the "Technical data" section (▷ page 271).



- ▶ Turn cap ① anti-clockwise and remove it.
- ▶ Top up the engine oil.  
If the oil level is at or below the MIN mark on the oil dipstick, top up once with a maximum of 1 l engine oil.
- ▶ Replace cap ① on the filler neck and turn clockwise.  
Make sure that the cap locks securely into place.
- ▶ Check the oil level again with the oil dipstick (▷ page 214).

## Front compartment

### Service cover

#### Important safety notes

### ⚠ WARNING

If the service cover is not locked, it may come loose during driving and block your

view or endanger other road users. There is a risk of an accident and injury.

Therefore, make sure that the service cover is locked before driving off.

### ⚠ WARNING

If the windscreen wipers start to move when the service cover is open, you could become caught up in the wiper rods. There is a risk of injury.

Always switch off the windscreen wipers and the ignition before you open the service cover.

- ❗ To ensure unhindered air intake, completely remove any dirt or snow from the ventilation slots above the service cover.

The service cover is attached to the rear side of the vehicle body with a strap.

- ▶ Park the vehicle on a flat, level surface.
- ▶ Apply the parking brake.
- ▶ Select a gear.
- ▶ Switch the ignition off.

#### Removing

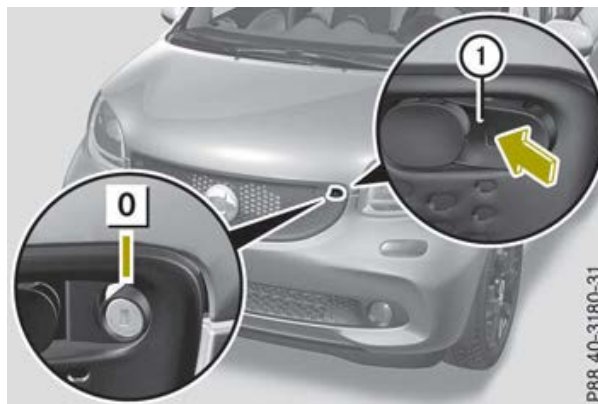

Vehicles with a lockable service cover:

- ▶ **To unlock:** remove lock cover ① (driver's side only) with the key.
- ▶ Insert the key into the lock and turn it to position 0.

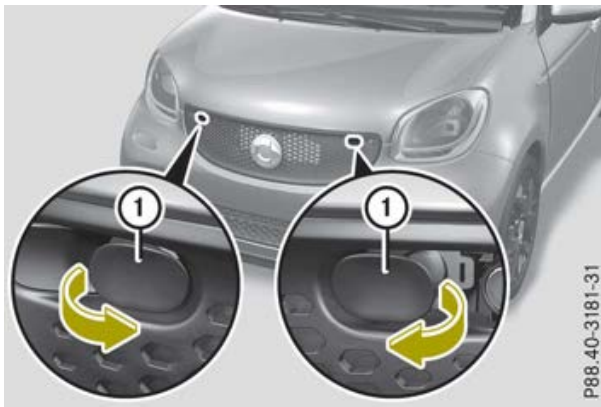

- ▶ Pull both levers ① with both index fingers in the direction of the arrows.

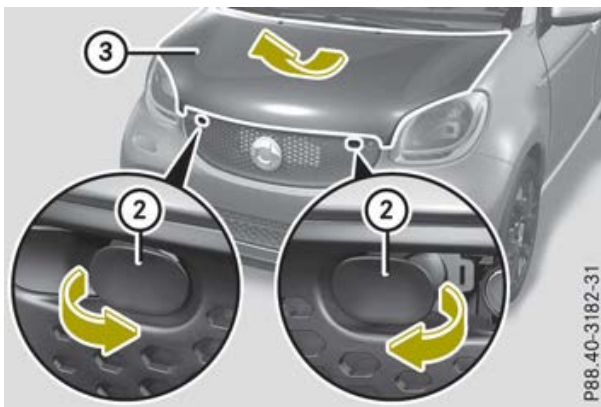

- ▶ First pull both levers ② forwards and then completely out.
- ▶ Lift service cover ③ and pull forwards.
- ▶ Put down service cover ③.

**Inserting**

- ▶ Unhook service cover ③.

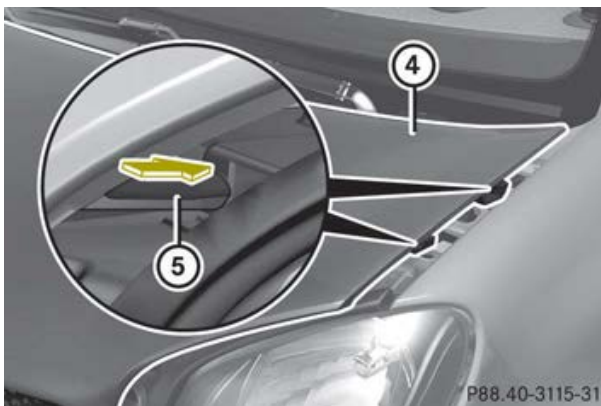

- ▶ Slide bars ⑤ on the left and right of the service cover under the bars on wing ④.

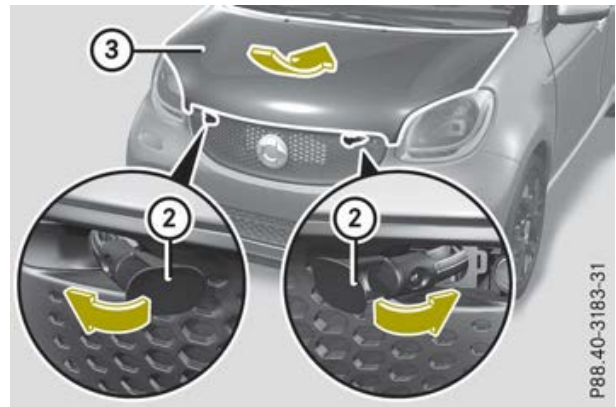

- ▶ Press service cover ③ down in the direction of the arrow.
- ▶ Slide both levers ② in and then back.
- ▶ Press lever ② in the radiator trim and allow it to engage.

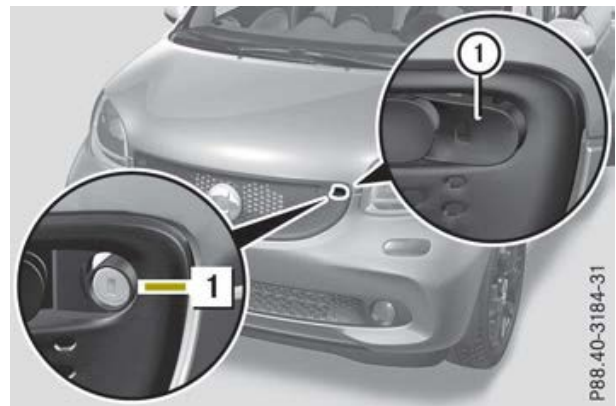

Vehicles with a lockable service cover:

- ▶ **To lock:** insert the key into the lock and turn it to position ①. Insert lock cover ① flush (on the driver's side) and clip it into place.

**Coolant**

**Important safety notes**

**⚠ WARNING**

The engine cooling system is under pressure, particularly if the engine is warm. You could be scalded by hot coolant spraying out when opening the cap. There is a danger of injury.

Allow the engine to cool before opening the cap. Wear gloves and protective eyewear

>> Maintenance and care.

when opening. Slowly turn the cap half a turn to allow pressure to escape.

### Checking the coolant

The coolant expansion tank is in the area under the service cover.

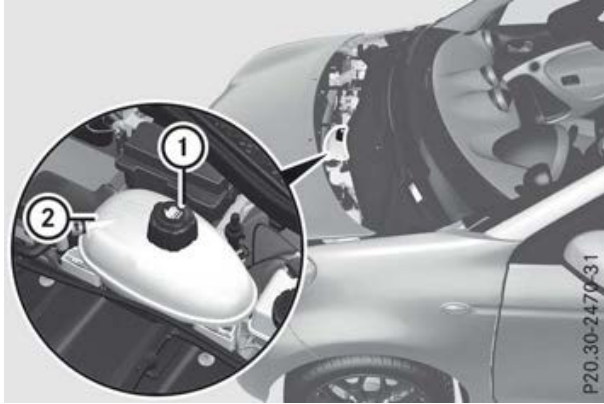

- ▶ Open the service cover (▷ page 216).
- ▶ Let the coolant cool down for at least 30 minutes.
- ▶ Park the vehicle on a level surface. Only check the coolant level if the vehicle is on a level surface and the engine has cooled down.
- ▶ Check the reservoir visually. The fluid level must be between MIN and MAX.

### Topping up the coolant

- ▶ Cover cap ① of coolant expansion tank ② with a cloth.
- ▶ Slowly turn cap ① by half a turn anti-clockwise to allow excess pressure to escape.
- ▶ Turn cap ① further anti-clockwise and remove it.
- ▶ Do not exceed the maximum filling level when adding coolant.
- ▶ Screw on cap ① tightly.

For further information on coolant, see (▷ page 272).

### Windscreen washer system

#### ⚠ WARNING

Windscreen washer concentrate is highly flammable. If it comes into contact with hot components in the front compartment, it may ignite. There is a risk of fire and injury.

Make sure that windscreen washer concentrate is not spilled next to the filler neck.

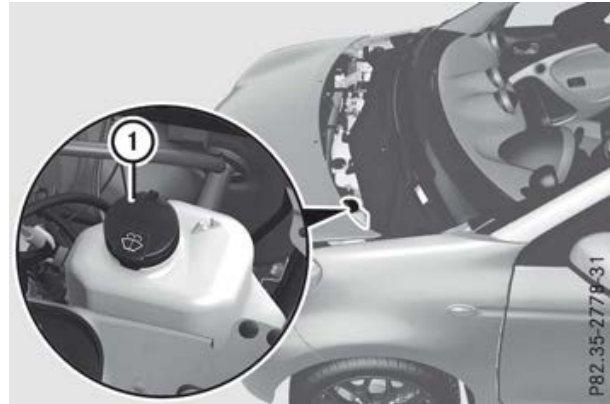

- ▶ Open the service cover (▷ page 216).
- ▶ **To open:** pull cap ① upwards by the tab.
- ▶ If available, pull the removable nozzle up as far as the stop.
- ▶ Top up with the premixed washer fluid.
- ▶ **To close:** if available, push the removable nozzle down and push it inside.
- ▶ Press cap ① onto the filler neck until it engages.

Further information on windscreen washer fluid/antifreeze (▷ page 273).

### Service

#### Service display

#### Service message

The service display informs you of the next service due date. Depending on the operating conditions of the vehicle, the remaining time or distance until the next service due date is displayed.



Information on the type of service and service intervals (see separate Service Booklet).

For further information enquire at any smart centre.



- i** The service display does not show any information on the engine oil level. Observe the notes on the engine oil level (▷ page 214).



Whenever a service is due, this is shown approximately 30 days or 1500 km (1000 mi) beforehand. After starting the engine, a service message appears in the instrument cluster display for a few seconds; see the following example.

- **Instrument cluster with monochrome display**

The  or  symbol flashes. If a service due date has been exceeded, a minus is shown before the information about the days or distance.

- **Instrument cluster with colour display**

**Next service due in .. days** together with the  or  symbol. If the service due date has been exceeded, **Service due .. days ago**.

The symbol shows the type of service.  stands for a minor service and  for a major service.

The service display does not take into account any periods of time during which the battery is disconnected.

Maintaining the time-dependent service schedule:

- ▶ Note down the service due date in the service display before disconnecting the battery.

or

- ▶ After reconnecting the battery, subtract the battery disconnection periods from the service date shown on the display.

## Hiding a service message

This function is only available with an instrument cluster with colour display.

- ▶ Press the  button on the multifunction steering wheel.



## Calling up the service display

- ▶ Switch the ignition on.
- ▶ Depending on the equipment in the vehicle, you can call up the service display with the buttons on the multifunction lever or on the multifunction steering wheel.

### Instrument cluster with monochrome display

- ▶ Use the  multifunction lever to select the **Service** menu. The service display shows when the service is due.

### Instrument cluster with colour display

- ▶ Press the  or  button on the steering wheel to select the **Messages and service** menu. The service display shows when the service is due.

## Information about Service

### Resetting the service display

- !** Have service work carried out as described in the Service Booklet. This may otherwise lead to increased wear and damage to the major assemblies or the vehicle.

A qualified specialist workshop, e.g. a smart centre, will reset the service interval display after the service work has been carried out. You can also obtain further information on maintenance work, for example.

### Special service requirements

The prescribed service interval is based on normal operation of the vehicle. Service work will need to be performed more often if the vehicle is operated under arduous conditions or increased loads, for example:

- regular city driving with frequent intermediate stops
- if the vehicle is primarily used to travel short distances
- for frequent operation in mountainous terrain or on poor road surfaces
- if the engine is often left idling for long periods

In these or similar operating conditions, have, for example, the air filter, engine oil and oil filter changed more frequently. The tyres must be checked more frequently if the vehicle is operated under increased loads. You can obtain further information at a qualified specialist workshop, e.g. a smart centre.

### Driving abroad

An extensive smart service network is also available in other countries. For further information enquire at any smart centre.

## Care

### General notes

#### Environmental note

Dispose of empty packaging and cleaning cloths in an environmentally responsible manner.

**!** For cleaning your vehicle, do not use any of the following:

- dry, rough or hard cloths
- abrasive cleaning agents
- solvents
- cleaning agents containing solvents

Do not scrub.

Do not touch the surfaces or protective films with hard objects, e.g. a ring or ice scraper. You could otherwise scratch or damage the surfaces and protective film.

**!** Do not park up the vehicle for an extended period straight after cleaning it, particularly after having cleaned the wheels with wheel cleaner. Wheel cleaners could cause increased corrosion of the brake discs and brake pads/linings. For this reason, you should drive for a few minutes after cleaning. Braking heats the brake discs and the brake pads/linings, thus drying them. The vehicle can then be parked up.

Regular care of your vehicle is a condition for retaining the quality in the long term. Use care products and cleaning agents recommended and approved by smart.

## Care of the exterior

### Automatic car wash

#### WARNING

Braking efficiency is reduced after the vehicle has been washed. There is a risk of an accident.

After washing the vehicle, brake carefully while paying attention to the traffic conditions in order to restore full braking efficiency.

**!** Make sure that:

- the side windows are fully closed
- the climate control blower is switched off
- the windscreen wiper switch is at position **0**

The vehicle could otherwise be damaged.

You can wash the vehicle in an automatic car wash from the very start.

Wash off excess dirt before cleaning the vehicle in an automatic car wash.

After using an automatic car wash, wipe off wax from the windscreen and the wiper blades. This will prevent smears and reduce wiping noises caused by residue on the windscreen.

### Washing by hand

In some countries, washing by hand is only allowed at specially equipped washing bays. Observe the legal requirements for each individual country.

- ▶ Do not use hot water and do not wash the vehicle in direct sunlight.
- ▶ Use a soft sponge to clean.
- ▶ Use a mild cleaning agent, such as a car shampoo approved by smart.
- ▶ Thoroughly hose down the vehicle with a gentle jet of water.
- ▶ Do not point the water jet directly towards the air inlet.
- ▶ Use plenty of water and rinse out the sponge frequently.
- ▶ Rinse the vehicle with clean water and dry thoroughly with a chamois.
- ▶ Do not let the cleaning agent dry on the paintwork.

When using the vehicle in winter, remove all traces of road salt deposits carefully and as soon as possible.

### High-pressure cleaning equipment

#### WARNING

The water jet of circular-jet nozzles (dirt grinders) can cause damage not visible from the outside to tyres or chassis components. Components damaged in this way can unexpectedly fail. There is a risk of an accident.

Do not use high-pressure cleaners with circular-jet nozzles to clean the vehicle. Have damaged tyres or chassis components replaced immediately.

**!** Always maintain a distance of at least 30 cm between the vehicle and the high-pressure cleaner nozzle. Information about the correct distance is available from the equipment manufacturer.

Move the high-pressure cleaner nozzle around when cleaning your vehicle.

Do not aim directly at any of the following:

- tyres
- door gaps, roof gaps, joints etc.
- electrical components
- battery
- connectors
- lights
- seals
- ventilation slots

Damaged seals or electrical components can lead to leaks or failures.

### Cleaning the paintwork

**!** Do not affix:

- stickers
- films
- magnetic plates or similar items

to painted surfaces. You could otherwise damage the paintwork.

- ▶ Remove impurities immediately, where possible, whilst avoiding rubbing too hard.
- ▶ Soak insect remains with insect remover and rinse off the treated areas afterwards.
- ▶ Soak bird droppings with water and rinse off the treated areas afterwards.
- ▶ Remove coolant, brake fluid, tree resin, oils, fuels and greases by rubbing gently with a cloth soaked in petroleum ether or lighter fluid.
- ▶ Use tar remover to remove tar stains.
- ▶ Use silicone remover to remove wax.

The following cannot always be completely repaired:

- scratches
- corrosive deposits
- areas affected by corrosion
- damage caused by inadequate care

In such cases, visit a qualified specialist workshop.

### Cleaning the wheels

#### WARNING

The water jet of circular-jet nozzles (dirt grinders) can cause damage not visible from the outside to tyres or chassis components. Components damaged in this way can unexpectedly fail. There is a risk of an accident.

Do not use high-pressure cleaners with circular-jet nozzles to clean the vehicle. Have damaged tyres or chassis components replaced immediately.

**!** Do not use acidic wheel cleaning products to remove brake dust. This could damage wheel bolts and brake components.

**!** Do not park up the vehicle for an extended period straight after cleaning it, particularly after having cleaned the wheels with wheel cleaner. Wheel cleaners could cause increased corrosion of the brake discs and brake pads/linings. For this reason, you should drive for a few minutes after cleaning. Braking heats the brake discs and the brake pads/linings, thus drying them. The vehicle can then be parked up.

### Cleaning the windows

#### WARNING

If the windscreen wipers are set in motion when cleaning the windscreen or wiper blades, you could become trapped. There is a danger of injury.

Always switch off the windscreen wipers and the ignition before cleaning the windscreen or wiper blades.

**!** Do not use dry cloths, abrasive products, solvents or cleaning agents containing solvents to clean the inside of the windows. Do not touch the insides of the windows with hard objects, e.g. an ice scraper or ring. There is otherwise a risk of damaging the windows.

**!** Clean the water drainage channels of the windscreen and the rear window at regular intervals. Deposits such as leaves, petals and pollen may under certain circumstances prevent water from draining away. This can lead to corrosion damage and damage to electronic components.

► Clean the inside and outside of the windows with a damp cloth and a cleaning agent that is recommended and approved by smart.

### Cleaning the wiper blades

#### WARNING

If the windscreen wipers are set in motion when cleaning the windscreen or wiper blades, you could become trapped. There is a danger of injury.

Always switch off the windscreen wipers and the ignition before cleaning the windscreen or wiper blades.

**!** Do not pull on the wiper blade. Otherwise, the wiper blade could be damaged.

**!** Do not clean wiper blades too often and do not rub them too hard. Otherwise, the graphite coating could be damaged. This could cause wiper noise.

- ▶ Fold the wiper arms away from the windscreen.
- ▶ Carefully clean the wiper blades with a damp cloth.
- ▶ Fold the windscreen wipers back again before switching on the ignition.

**!** Hold the wiper arm securely when folding back. The windscreen could be damaged if the wiper arm hits against it suddenly.

### Cleaning the exterior lighting

**!** Only use cleaning agents or cleaning cloths that are suitable for plastic lenses. Unsuitable cleaning agents or cleaning cloths could scratch or damage the plastic lenses of the exterior lighting.

- ▶ Clean the plastic lenses of the exterior lighting using a wet sponge and a mild cleaning agent, e.g. smart car shampoo or cleaning cloths.

### Cleaning the sensors

**!** If you clean the sensors with a high-pressure cleaner, make sure that you keep a distance of at least 30 cm between the vehicle and the high-pressure cleaner nozzle. Information about the correct distance is available from the equipment manufacturer.

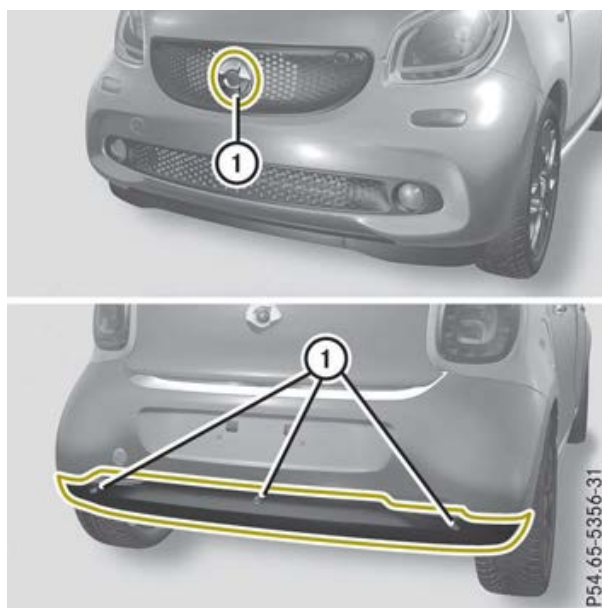

- ▶ Clean sensors ① of the driving systems with water, car shampoo and a soft cloth.

### Cleaning the reversing camera

**!** Do not clean the camera lens and the area around the reversing camera with a high-pressure cleaner.

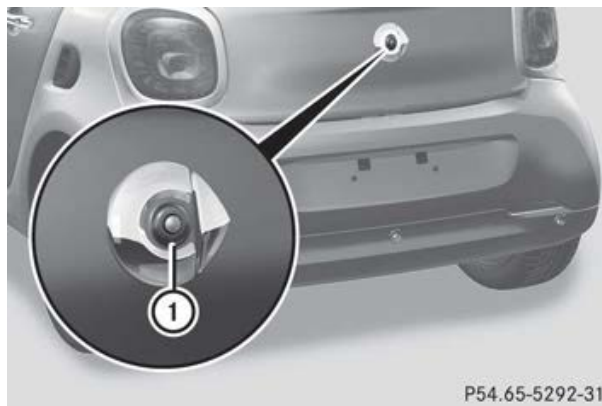

- ▶ Use clear water and a soft cloth to clean camera lens ①.

### Cleaning the exhaust pipe

Impurities combined with the effects of road grit and corrosive environmental factors may cause flash rust to form on the surface. You can restore the original shine of the exhaust pipe by cleaning it regularly, especially in winter and after washing.

- ❗ Do not clean the exhaust pipe with acid-based cleaning agents, such as sanitary cleanser or wheel cleaner.
- ▶ Clean the exhaust pipe with a care product tested and approved by smart.

### Interior care

#### Cleaning the display

- ❗ For cleaning, do not use any of the following:
  - alcohol-based thinner or petrol
  - abrasive cleaning agents
  - commercially-available household cleaning agents

These may damage the display surface. Do not put pressure on the display surface when cleaning. This could lead to irreparable damage to the display.

- ▶ Before cleaning the display, make sure that it is switched off and has cooled down.
- ▶ Clean the display surface using a commercially available microfibre cloth and TFT/LCD display cleaner.
- ▶ Dry the display surface using a dry microfibre cloth.

#### Cleaning the plastic trim

##### WARNING

Care products and cleaning agents containing solvents can cause surfaces in the cockpit to become porous. This could result in plastic parts breaking away when the airbags are deployed. There is a danger of injury.

Do not use care products and cleaning agents containing solvents to clean the cockpit.

- ❗ Do not affix the following to plastic surfaces:

- stickers
- films
- scented oil bottles or similar items

You could otherwise damage the plastic.

- ❗ Do not allow cosmetics, insect repellent or sunscreen to come in contact with the plastic trim. This maintains the high-quality look of the surfaces.

- ▶ Wipe the plastic trim with a damp, lint-free cloth, e.g. a microfibre cloth.
- ▶ **Heavy soiling:** use care products and cleaning agents recommended and approved by smart. The surface may change colour temporarily. Wait until the surface is dry again.

#### Cleaning the steering wheel and gear or selector lever

- ▶ Thoroughly wipe with a damp cloth or use leather care agents that have been recommended and approved by smart.

#### Cleaning the seat covers

##### General notes

- ❗ Do not use microfibre cloths to clean genuine leather, artificial leather or DINAMICA covers. If used often, these can damage the cover.
- i Note that regular care is essential to make sure that the appearance and comfort of the covers are retained over time.

##### Genuine leather seat covers

Leather is a natural product.

It has natural surface properties, e.g.:

- unevenness in structure
- marks caused by growth and injury
- subtle colour differences

These are characteristics of leather and not material faults.

**!** To maintain the leather's natural appearance, observe the following cleaning tips:

- clean genuine leather covers carefully with a damp cloth and then wipe the covers down with a dry cloth.
- Make sure that the leather does not become soaked. It may otherwise become rough and cracked.
- Only use leather care agents that have been recommended by smart. You can obtain these from a qualified specialist workshop.

### Seat covers from other materials

**!** Observe the following when cleaning:

- clean artificial leather covers with a cloth moistened with a solution containing 1% detergent (e.g. washing-up liquid).
- clean cloth covers with a microfibre cloth moistened with a solution containing 1% detergent (e.g. washing-up liquid). Rub carefully, and always wipe entire seat sections to avoid leaving visible lines. Leave the seat to dry afterwards. Cleaning results depend on the type of dirt and how long it has been there.
- Clean DINAMICA covers with a damp cloth. Make sure that you wipe entire seat sections to avoid leaving visible lines.

### Cleaning the seat belts

#### **WARNING**

Seat belts may be severely weakened if bleached or coloured. This may lead to the seat belts, for example, tearing or failing in an accident. There is an increased risk of injury, possibly even fatal.

Never bleach or colour seat belts.

**!** Do not clean the seat belts using chemical cleaning agents. Do not dry the seat

belts at temperatures above 80 °C or in direct sunlight.

- ▶ Use clean, lukewarm water and soap solution.

### Cleaning the roof lining and carpets

- ▶ **Roof lining:** if it is very dirty, use a soft brush or a cleaning agent recommended and approved by smart.
- ▶ **Carpets:** use the carpet and textile cleaning agents recommended and approved by smart.



Useful information .....	228
Where will I find...? .....	228
Flat tyres .....	229
Battery (vehicle) .....	233
Jump-starting .....	236
Towing and tow-starting .....	238
Electrical fuses .....	241

## Useful information

**i** This Owner's Manual describes all models, series and optional equipment for your vehicle that were available at the time of going to press. Country-specific differences are possible. Note that your vehicle may not be fitted with all features described. This is also the case for systems and functions relevant to safety.

**i** Read the information on qualified specialist workshops: (▷ page 21).

>> Breakdown assistance.

## Where will I find...?

## Warning triangle

## Removing/replacing the warning triangle

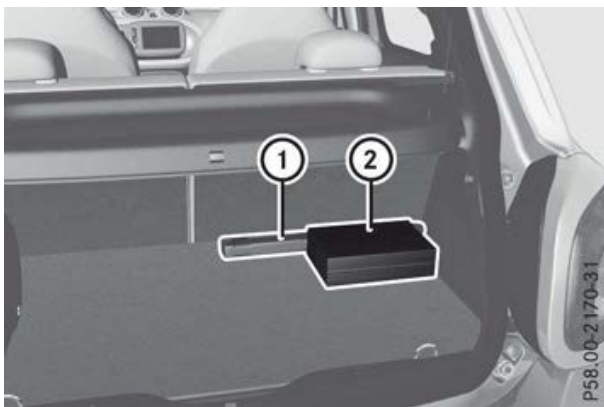

Warning triangle ① is located in the boot behind the rear seat backrest, secured to the carpet with a Velcro fastener.

- ▶ Remove warning triangle ① from the boot.
- ▶ **To replace:** press the side of warning triangle ① with the Velcro fastener firmly in the relevant position.

## Setting up the warning triangle

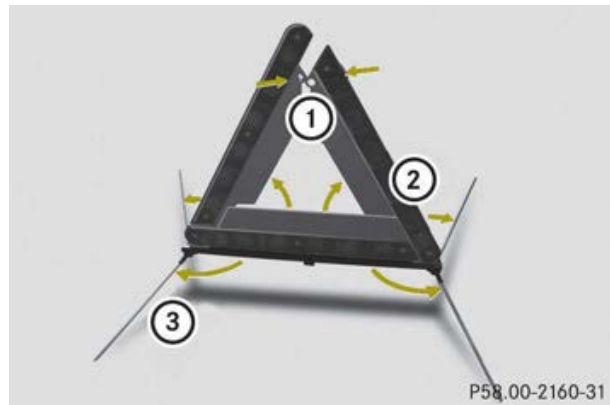

- ▶ Fold feet ③ out to the side.
- ▶ Pull side reflectors ② upwards to form a triangle and lock them at the top using upper press-stud ①.

## First-aid kit

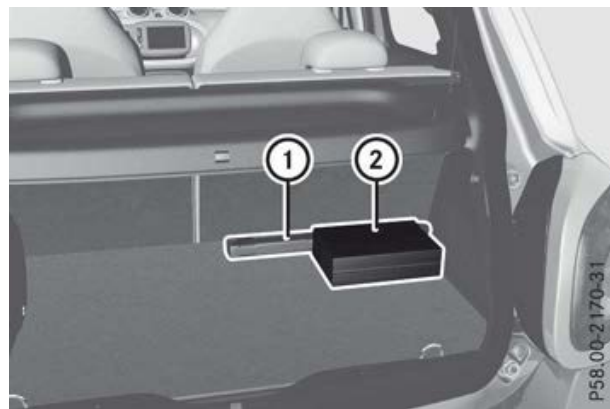

First-aid kit ② is located in the boot behind the rear seat backrest, secured to the carpet with a Velcro fastener.

- ▶ **To remove:** remove first-aid kit ②.
- ▶ **To replace:** press the side of first-aid kit ② with the Velcro fastener firmly in the relevant position.

**i** Check the use-by date on first-aid kit ② at least once a year. Replace the contents if necessary, and replace any missing items.

### Fire extinguisher

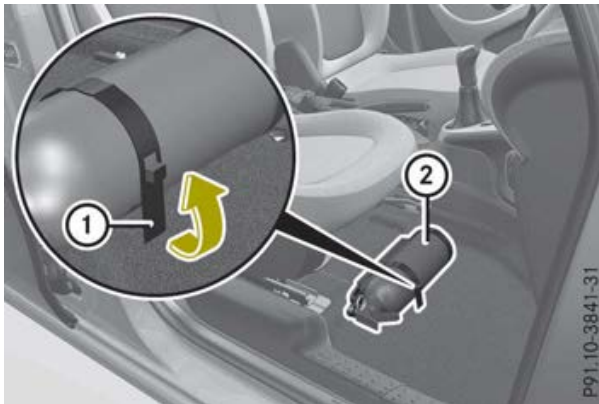

Fire extinguisher ② is located in front of the passenger's seat.

- ▶ Pull tab ① forwards.
- ▶ Remove fire extinguisher ②.

**i** Have fire extinguisher ② refilled after each use and checked every one to two years. It may otherwise fail in an emergency.

Observe the legal requirements for each individual country.

### Vehicle tool kit

The TIREFIT kit and the towing eye are located in the stowage well under the front-passenger footwell.

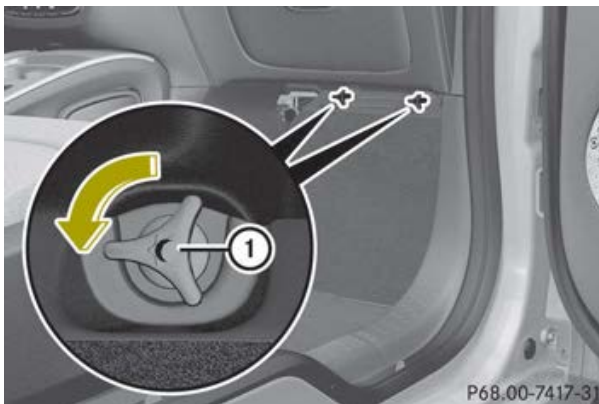

- ▶ Unscrew wing nuts ①.
- ▶ Remove the vehicle tool tray.



- ① Towing eye
- ② Tyre sealant filler bottle
- ③ Tyre inflation compressor

### Flat tyres

#### Preparing the vehicle

Your vehicle may be equipped with a TIREFIT kit (▷ page 229).

Information on changing a wheel/fitting (▷ page 256).

- ▶ Stop the vehicle as far away as possible from traffic on solid, non-slippery and level ground.
- ▶ Switch on the hazard warning lamps.
- ▶ Secure the vehicle against rolling away (▷ page 138).
- ▶ If possible, bring the front wheels into the straight-ahead position.
- ▶ Switch off the engine.
- ▶ Remove the key from the ignition lock.
- ▶ Make sure that the passengers are not endangered as they get out of the vehicle. Make sure that no one is near the danger area while a wheel is being changed. Anyone who is not directly assisting in the wheel change should, for example, stand behind the barrier.
- ▶ Get out of the vehicle. Pay attention to traffic conditions when doing so.

>> Breakdown assistance.

- ▶ Close the driver's door.
- ▶ Place the warning triangle a suitable distance away (▷ page 228). Observe legal requirements.

### TIREFIT kit

#### Important safety notes

TIREFIT is a tyre sealant.

You can use TIREFIT to seal punctures of up to 4 mm, particularly those in the tyre tread. You can use TIREFIT at outside temperatures down to -20 °C.

#### ⚠ WARNING

In the following situations, the tyre sealant is unable to provide sufficient breakdown assistance, as it is unable to seal the tyre properly:

- there are cuts or punctures in the tyre larger than those mentioned above.
- the wheel rim is damaged.
- you have driven at very low tyre pressures or on a flat tyre.

There is a risk of an accident.

Do not drive any further. Contact a qualified specialist workshop.

#### ⚠ WARNING

The tyre sealant is harmful and causes irritation. It must not come into contact with your skin, eyes or clothing or be swallowed. Do not inhale TIREFIT fumes. Keep tyre sealant away from children. There is a risk of injury.

If you come into contact with the tyre sealant, observe the following:

- Rinse off the tyre sealant from your skin immediately with water.
- If the tyre sealant comes into contact with your eyes, immediately rinse them thoroughly with clean water.
- If tyre sealant is swallowed, immediately rinse your mouth out thoroughly and

drink plenty of water. Do not induce vomiting, and seek medical attention immediately.

- Immediately change out of clothing which has come into contact with tyre sealant.
- If an allergic reaction occurs, seek medical attention immediately.

**!** Do not operate the tyre inflation compressor for longer than 15 minutes at a time without a break. It may otherwise overheat.

The tyre inflation compressor can be operated again once it has cooled down.

Comply with the manufacturer's safety instructions on the sticker on the tyre inflation compressor.

#### Using the TIREFIT kit

- ▶ Do not remove any foreign objects which have penetrated the tyre, e.g. screws or nails.
- ▶ Remove the tyre sealant bottle and the tyre inflation compressor from the front-passenger footwell (▷ page 229).
- ▶ Affix the 80 km/h maximum speed sticker to the instrument cluster within the driver's field of vision.

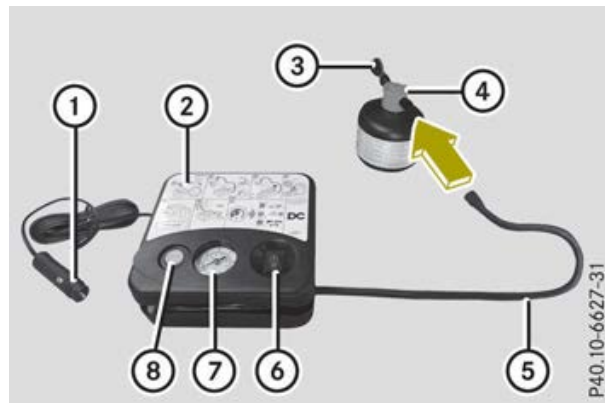

- ▶ Unwind plug ① with the cable from the tyre inflation compressor ②.
- ▶ Remove hose ⑤ from the bottom section of tyre inflation compressor housing ②.
- ▶ Remove cap on tyre sealant bottle ④ and connect hose ⑤.



- ▶ Remove the cap from valve ⑨ on the faulty tyre.
- ▶ Remove cap on filler hose ③ and screw filler hose ③ onto the valve.
- ▶ Insert plug ① into the socket of the cigarette lighter (▷ page 211) or into the 12 V power socket in your vehicle (▷ page 212).
- ▶ Turn the key to position 1 in the ignition lock (▷ page 121).
- ▶ Press on/off switch ⑥ on tyre inflation compressor ② to I.  
The tyre inflation compressor is switched on. The tyre is inflated.

**i** First, tyre sealant is pumped into the tyre. The pressure can briefly rise to approximately 600 kPa (6.0 bar/86 psi).

**Do not switch off the tyre inflation compressor during this phase.**

- ▶ Let the tyre inflation compressor run for a maximum of 15 minutes. The tyre should then have attained a pressure of at least 180 kPa (1.8 bar/26 psi).

If a tyre pressure of 180 kPa (1.8 bar/26 psi) is achieved after a maximum of 15 minutes, see "Tyre pressure is achieved" (▷ page 231).

If a tyre pressure of 180 kPa (1.8 bar/26 psi) has not been achieved after a maximum of 15 minutes, see "Tyre pressure is not achieved" (▷ page 231).

**i** If the tyre sealant leaks out, allow it to dry. It can then be removed like a layer of film.

If you get tyre sealant on your clothing, have it cleaned as soon as possible with perchloroethylene.

### Tyre pressure not reached

If a tyre pressure of 180 kPa (1.8 bar/26 psi) has not been achieved after a maximum of 10 minutes:

- ▶ Switch off the tyre inflation compressor.
- ▶ Unscrew the filler hose from the valve of the defective tyre.
- ▶ Very slowly drive forwards or reverse approximately 10 m.
- ▶ Pump up the tyre again.  
After a maximum of 10 minutes, the tyre pressure must be at least 180 kPa (1.8 bar/26 psi).

#### **⚠ WARNING**

If the required tyre pressure is not reached after the specified time, the tyre is too badly damaged. The tyre sealant cannot repair the tyre in this instance. Damaged tyres and a tyre pressure that is too low can significantly impair the vehicle's braking and driving characteristics. There is a risk of accident.

Do not continue driving. Contact a qualified specialist workshop.

### Tyre pressure reached

#### **⚠ WARNING**

A tyre temporarily sealed with tyre sealant impairs the driving characteristics and is not suitable for higher speeds. There is a risk of accident.

You should therefore adapt your driving style accordingly and drive carefully. Do not exceed the specified maximum speed with a tyre that has been repaired using tyre sealant.

The maximum speed for a tyre sealed with tyre sealant is 80 km/h. The 80 km/h maximum speed sticker must be affixed to the instrument cluster within the driver's field of vision.

**!** After use, excess tyre sealant may run out of the filler hose. This could cause stains.

Therefore, place the filler hose in the plastic bag that contained the TIREFIT kit.

**♻ Environmental note**

Have the used tyre sealant bottle disposed of professionally, e.g. at a qualified specialist workshop.

If a tyre pressure of 180 kPa (1.8 bar/26 psi) has been achieved after 10 minutes:

- ▶ Switch off the tyre inflation compressor.
- ▶ Unscrew the filler hose from the valve of the defective tyre.
- ▶ Stow the tyre sealant bottle, the tyre inflation compressor and the warning triangle.
- ▶ **Pull away immediately.**
- ▶ Stop after driving for approximately 3 km and check the tyre pressure with the tyre inflation compressor. The tyre pressure must now be at least 130 kPa (1.3 bar/19 psi).

**⚠ WARNING**

If the required tyre pressure is not reached after driving for a short period, the tyre is too badly damaged. The tyre sealant cannot repair the tyre in this instance. Damaged tyres and a tyre pressure that is too low can significantly impair the vehicle's braking

and driving characteristics. There is a risk of accident.

Do not continue driving. Contact a qualified specialist workshop.

- ▶ Correct the tyre pressure if it is still at least 130 kPa (1.3 bar/19 psi). For values, see the tyre pressure information label on the driver's side B-pillar.
- ▶ **To increase the tyre pressure:** switch on the tyre inflation compressor.



- ▶ **To reduce the tyre pressure:** depress pressure release button ① next to pressure gauge ②.
- ▶ If the tyre pressure is correct, unscrew the filler hose from the valve of the sealed tyre.
- ▶ Screw the valve cap onto the valve of the sealed tyre.
- ▶ Drive to the nearest qualified specialist workshop and have the tyre changed there.
- ▶ Have the tyre sealant bottle and the filler hose replaced as soon as possible at a qualified specialist workshop.
- ▶ Have the tyre sealant bottle replaced every four years at a qualified specialist workshop.

**Battery (vehicle)****Important safety notes**

Work on the battery, e.g. removing or installing, requires specialist knowledge and the use of special tools. Therefore, always have work on the battery carried out at a qualified specialist workshop.

**⚠ WARNING**

Work carried out incorrectly on the battery can lead, for example, to a short circuit and thus damage the vehicle electronics. This can lead to function restrictions applying to safety-relevant systems, e.g the lighting system, the ABS (anti-lock braking system) or the ESP® (Electronic Stability Program). The operating safety of your vehicle may be restricted.

You could lose control of the vehicle, for example:

- when braking
- in the event of abrupt steering manoeuvres and/or when the vehicle's speed is not adapted to the road conditions

There is a risk of an accident.

In the event of a short circuit or a similar incident, contact a qualified specialist workshop immediately. Do not drive any further. Always have work on the battery carried out at a qualified specialist workshop.

Further information about ABS (▷ page 62) and esp® (▷ page 64).

**⚠ WARNING**

Electrostatic build-up can lead to the creation of sparks, which could ignite the highly explosive gases of a battery. There is a risk of an explosion.

Before handling the battery, touch the vehicle body to remove any existing electrostatic build-up.

The highly flammable gas mixture is created while the battery is charging and when jump-starting.

Always make sure that neither you nor the battery is electrostatically charged. Electrostatic charge is created, for example:

- by wearing synthetic fibre clothing
- due to friction between clothing and the seat
- when you pull or push the battery across carpet or other synthetic materials
- when you rub the battery with a cloth

**⚠ WARNING**

During the charging process, a battery produces hydrogen gas. If a short circuit occurs or sparks are created, the hydrogen gas can ignite. There is a risk of an explosion.

- Make sure that the positive terminal of a connected battery does not come into contact with vehicle parts.
- Never place metal objects or tools on a battery.
- It is important that you observe the described order of the battery terminals when connecting and disconnecting a battery.
- When jump-starting, make sure that the battery poles with identical polarity are connected.
- It is particularly important to observe the described order when connecting and disconnecting the jump leads.
- Never connect or disconnect the battery terminals while the engine is running.

**⚠ WARNING**

Battery acid is caustic. There is a risk of injury.

Avoid contact with the skin, eyes or clothing. Do not breathe in any battery gases. Do not lean over the battery. Keep the batteries out of the reach of children. Immediately rinse off battery acid thoroughly with

plenty of clean water and seek medical attention at once.

 **Environmental note**



Batteries contain pollutants. It is illegal to dispose of them with the household rubbish. They must be collected separately and disposed of in an environmentally responsible recycling system.



Dispose of batteries in an environmentally responsible manner. Take discharged batteries to a qualified specialist workshop or to a collection point for used batteries.

**!** Have the battery checked regularly at a qualified specialist workshop.

Observe the service intervals in the Service Booklet or contact a qualified specialist workshop for more information.

**!** You should have all work involving the battery carried out at a qualified specialist workshop. If, in exceptional circumstances, you need to disconnect the battery yourself, please make sure that:

- you have switched off the engine and removed the key. Check to see that there are no indicator lamps lighting in the instrument cluster. Electronic components such as the alternator may otherwise be damaged.
- you have first removed the negative terminal and then the positive terminal. Never mix up the terminal clamps. The vehicle's electronics system may otherwise be damaged.

The battery and the cover of the positive terminal clamp must be fitted securely during operation.

Comply with safety precautions and take protective measures when handling batteries.



WARNING



Fire, naked flames and smoking are prohibited when handling the battery. Avoid creating sparks.



Battery acid is caustic. Avoid contact with the skin, eyes or clothing.

Wear suitable protective clothing, in particular gloves, an apron and a face mask.

Immediately rinse acid splashes off with clean water. Consult a doctor if necessary.



Wear eye protection.



Keep children away.



Observe this Owner's Manual.

For safety reasons, smart recommends that you only use batteries which have been tested and approved specifically for your vehicle by smart. These batteries provide increased impact protection to prevent vehicle occupants from suffering acid burns should the battery be damaged in the event of an accident.

In order for the battery to achieve the maximum possible service life, it must always be sufficiently charged.

Like other batteries, the vehicle battery may discharge over time if you do not use the vehicle. In such cases, have the battery disconnected at a qualified specialist workshop. To maintain the charge, you can

also charge the battery with a charger recommended by smart. For more information, please contact a qualified specialist workshop.

Have the battery charge checked more frequently if you use the vehicle mainly for short trips or if you leave it standing idle for a lengthy period. Consult a qualified specialist workshop if you wish to leave your vehicle parked up for a long period of time.

- i** When you park the vehicle, remove the key if you do not require any electrical consumers. The vehicle will then use very little energy, thus conserving battery power.

### Charging the battery

#### WARNING

During charging and jump-starting, explosive gases can escape from the battery. There is a risk of an explosion.

Particularly avoid fire, naked flames, creating sparks and smoking. Ensure there is sufficient ventilation while charging and jump-starting. Do not lean over a battery.

#### WARNING

Battery acid is caustic. There is a risk of injury.

Avoid contact with the skin, eyes or clothing. Do not breathe in any battery gases. Do not lean over the battery. Keep the batteries out of the reach of children. Immediately rinse off battery acid thoroughly with plenty of clean water and seek medical attention at once.

#### WARNING

A discharged battery can freeze at temperatures below freezing point. When jump-starting the vehicle or charging the battery, gases can escape from the battery. There is a risk of an explosion.

Allow the frozen battery to thaw out before charging it or jump-starting.

- !** Only use battery chargers with a maximum charging voltage of 14.8 V.
- ▶ Open the service cover (▷ page 216).
- ▶ Connect the battery charger to the positive terminal and earth point in the same order as when connecting the donor battery in the jump-starting procedure (▷ page 236).

If the indicator/warning lamps do not light up at low temperatures, it is very likely that the discharged battery has frozen. In this case you may neither jump-start the vehicle nor charge the battery. The service life of a battery that has been thawed may be reduced. The starting characteristics may be impaired, especially at low temperatures. Have the thawed battery checked at a qualified specialist workshop.

Only charge the fitted battery with a battery charger which has been tested and approved by smart. A battery charger specially adapted for smart vehicles, and tested and approved by smart, is available as an accessory. It permits the charging of the battery in its installed position. Contact a smart centre for further information and availability. Read the battery charger's operating instructions before charging the battery.

## Jump-starting

### WARNING

Battery acid is caustic. There is a risk of injury.

Avoid contact with the skin, eyes or clothing. Do not breathe in any battery gases. Do not lean over the battery. Keep the batteries out of the reach of children. Immediately rinse off battery acid thoroughly with plenty of clean water and seek medical attention at once.

### WARNING

During charging and jump-starting, explosive gases can escape from the battery. There is a risk of an explosion.

Particularly avoid fire, naked flames, creating sparks and smoking. Ensure there is sufficient ventilation while charging and jump-starting. Do not lean over a battery.

### WARNING

During the charging process, a battery produces hydrogen gas. If a short circuit occurs or sparks are created, the hydrogen gas can ignite. There is a risk of an explosion.

- Make sure that the positive terminal of a connected battery does not come into contact with vehicle parts.
- Never place metal objects or tools on a battery.
- It is important that you observe the described order of the battery terminals when connecting and disconnecting a battery.
- When jump-starting, make sure that the battery poles with identical polarity are connected.
- It is particularly important to observe the described order when connecting and disconnecting the jump leads.
- Never connect or disconnect the battery terminals while the engine is running.

### WARNING

A discharged battery can freeze at temperatures below freezing point. When jump-starting the vehicle or charging the battery, gases can escape from the battery. There is a risk of an explosion.

Allow the frozen battery to thaw out before charging it or jump-starting.

**!** Avoid repeated and lengthy starting attempts. Otherwise, the catalytic converter could be damaged by the non-combusted fuel.

If the indicator/warning lamps do not light up at low temperatures, it is very likely that the discharged battery has frozen. In this case you may neither jump-start the vehicle nor charge the battery. The service life of a battery that has been thawed may be reduced. The starting characteristics may be impaired, especially at low temperatures. Have the thawed battery checked at a qualified specialist workshop.

Do not use a rapid charging device to start the vehicle. If your vehicle's battery is discharged, the engine can be jump-started from another vehicle or from a second battery using jump leads. Observe the following points:

- The battery is not accessible in all vehicles. If the other vehicle's battery is not accessible, jump-start the vehicle using a second battery or a jump-starting device.
- You may only jump-start the vehicle when the engine and exhaust system are cold.
- Do not start the engine if the battery is frozen. Let the battery thaw first.
- Jump-starting may only be performed from batteries with a nominal voltage of 12 V.
- Only use jump leads that have a sufficient cross-section and insulated terminal clamps.
- If the battery is fully discharged, leave the battery that is being used to jump-start connected for a few minutes before attempting to start. This charges the empty battery a little.
- Make sure that the two vehicles do not touch.

Make sure that:

- The jump leads are not damaged.
  - Bare parts of the terminal clamp do not come into contact with other metal parts while the jump leads are connected to the battery.
  - The jump leads cannot come into contact with parts which can move when the engine is running, such as the wiper rods or the fan.
- Secure the vehicle using the parking brake.
- Turn the key to position **0** in the ignition lock and remove it.
- Switch off all electrical consumers, e.g. rear window heating, lighting etc.
- Open the service cover.

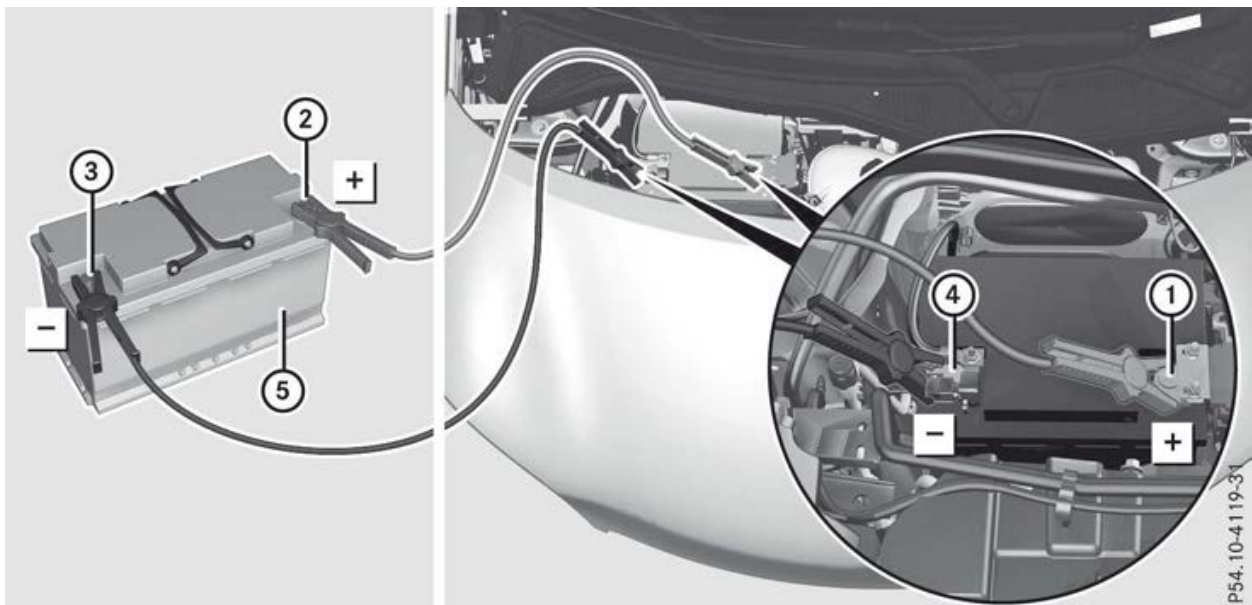

Position number ⑤ identifies the charged battery of the other vehicle or an equivalent jump-starting device.

- ▶ Remove the protective cover from positive terminal ①.
  - ▶ Connect positive terminal ① on your battery to positive terminal ② of donor battery ⑤ using the jump lead. Begin with your own battery.
  - ▶ Start the engine of the donor vehicle and run it at idling speed.
  - ▶ Connect negative terminal ③ of donor battery ⑤ to negative terminal ④ of your battery using the jump lead. Connect the jump lead to donor battery ⑤ first.
  - ▶ Start the engine.
  - ▶ Before disconnecting the jump leads, let the engines run for several minutes.
  - ▶ First disconnect the jump lead from negative terminal ④ and negative terminal ③ and then from positive terminal ① and positive terminal ②. Begin each time at the contacts on your own vehicle first.
  - ▶ Attach the protective cover to positive terminal ①.
  - ▶ Have the battery checked at a qualified specialist workshop.
- i** Jump-starting is not considered to be a normal operating condition.
- i** Jump-starting cables and further information regarding jump-starting can be obtained at any qualified specialist workshop.

>> Breakdown assistance.

## Towing and tow-starting

### Important safety notes

#### WARNING

Safety relevant functions are restricted or no longer available if:

- the engine is not running
- the brake system or power steering is malfunctioning
- there is a malfunction in the voltage supply or the vehicle's electrical system

When your vehicle is towed away or towed started, you may require considerably more effort to steer and brake. There is a risk of an accident.

In such cases use a rigid towing bar. Before being towed away or tow started, make sure the steering moves freely.

#### WARNING

If the steering wheel lock is engaged, the vehicle can no longer be steered. There is a risk of an accident.

Always switch on the ignition when towing with a tow rope or a towing bar.

#### WARNING

When towing or tow-starting another vehicle and its weight is greater than the permissible gross weight of your vehicle, the:

- towing eye may be torn off
- car/trailer combination may swerve or even overturn

There is a risk of an accident.

When towing or tow-starting another vehicle, its weight should not be greater than the permissible gross weight of your vehicle.

Information on your vehicle's gross vehicle weight rating can be found on the vehicle identification plate (▷ page 267).

**!** Observe the following points when towing with a tow rope:

- secure the tow rope on the same side on both vehicles.
- make sure that the tow rope is not longer than legally permitted. Mark the tow rope in the middle, e.g. with a white cloth (30 x 30 cm). This makes other road users aware that a vehicle is being towed.
- only secure the tow rope to the towing eye.
- observe the brake lamps of the towing vehicle while driving. Always maintain a distance so that the tow rope does not sag.
- do not use steel cables or chains to tow your vehicle. You could otherwise damage the vehicle.

**!** Do not use the towing eyes for recovery purposes as this could damage the vehicle. If in doubt, recover the vehicle with a crane.

**!** Pull away smoothly when towing away or tow-starting a vehicle. If the tractive power is too high, the vehicles could be damaged.

**!** You may tow the vehicle for a maximum of 50km. A towing speed of 50 km/h must not be exceeded.

For towing distances over 50 km, the entire vehicle must be lifted up and transported.

Observe the legal requirements for the relevant countries when towing and tow-starting.

It is better to have the vehicle transported than to have it towed.

The battery must be connected and charged. Otherwise, you cannot turn the key to position **2** in the ignition lock.

**i** Before the vehicle is towed, switch off the automatic locking feature (▷ page 73). You could otherwise be

locked out when pushing or towing the vehicle.

**i** **Vehicles with the basic carrier fitted:**

Do not tow away the vehicle with the basic carrier fitted.

Do not secure the tow cable or tow bar to the basic carrier.

### Fitting/removing the towing eye

#### Fitting the towing eye

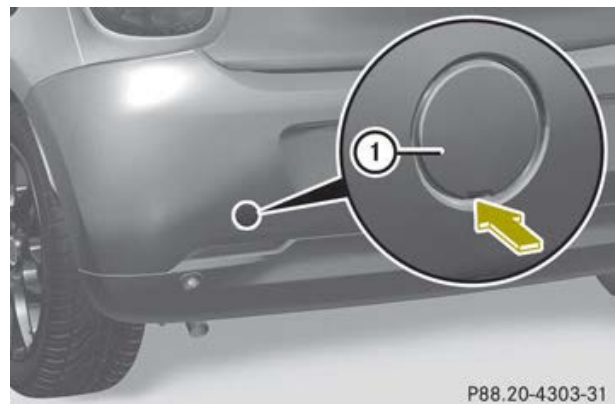

► Remove the towing eye from the stowage space.

The towing eye is located in the vehicle tool kit stowage compartment in the front-passenger footwell (▷ page 229).

► Carefully prise out cover **1** using a suitable tool, e.g. a plastic wedge.

► Screw in the towing eye clockwise to the stop and tighten it.

### Removing the towing eye

- ▶ Loosen the towing eye and unscrew it.
- ▶ Position top of cover ① in the bumper and press it in at the bottom until it engages.
- ▶ Place the towing eye in the vehicle tool kit stowage compartment in the front-passenger footwell (▷ page 229).

### Towing the vehicle with the rear axle raised

When towing your vehicle with the rear axle raised, it is important that you observe the safety instructions (▷ page 238).

- ❗ The ignition must be switched off if you are towing the vehicle with the rear axle raised. Intervention by ESP® could otherwise damage the brake system.
- ▶ Switch on the hazard warning lamps (▷ page 96).
- ▶ Bring the front wheels into the straight-ahead position.
- ▶ Turn the key to position **0** in the ignition lock and remove the key from the ignition lock.
- ▶ When leaving the vehicle, take the key with you.

### Towing the vehicle with both axles on the ground

- i In order to signal a change of direction when towing with the hazard warning lamps switched on, use the combination switch as usual. In this case, only the turn signals for the desired direction flash. When you reset the combination switch, the hazard warning lamps start flashing again.

- ▶ Make sure that the vehicle is stationary.
- ▶ Turn the key to position **2** in the ignition lock.
- ▶ Depress and hold the brake pedal.
- ▶ Leave the key in position **2** in the ignition lock.
- ▶ Release the brake pedal.
- ▶ Release the parking brake.
- ▶ Switch on the hazard warning lamps (▷ page 96).

It is important that you observe the safety instructions when towing away your vehicle (▷ page 238).

### Transporting the vehicle

- ❗ You may only secure the vehicle by the wheels, not by parts of the vehicle such as axle or steering components. Otherwise, the vehicle could be damaged.
- ▶ Turn the key to position **2** in the ignition lock.

### As soon as the vehicle is loaded:

- ▶ Prevent the vehicle from rolling away by applying the parking brake.
- ▶ Turn the key to position **0** in the ignition lock and remove it.
- ▶ Secure the vehicle.

The towing eye can be used to pull the vehicle onto a trailer or transporter for transporting purposes.

### Tow-starting (emergency engine starting)

- i You can find information on "Jump-starting" at (▷ page 236).

Before tow-starting the following conditions must be fulfilled:

- the battery is connected.
- the engine has cooled down.
- the exhaust system has cooled down.

When tow-starting, it is important that you observe the safety instructions (▷ page 238) and the legal requirements in each respective country.

- ▶ Switch on the hazard warning lamps (▷ page 96).
- ▶ Fit the towing eye (▷ page 239).
- ▶ Secure the rigid towing bar or the towing rope.
- ▶ Depress and hold the brake pedal.
- ▶ Turn the key to position **2** in the ignition lock.
- ▶ Depress the clutch pedal fully, engage second gear and keep the clutch pedal fully depressed.
- ▶ Release the brake pedal.
- ▶ Tow-start the vehicle.
- ▶ Release the clutch pedal slowly; do not depress the accelerator pedal while doing so.
- ▶ When the engine is started, immediately depress the clutch pedal fully and select neutral.
- ▶ Pull over at a suitable place and stop the vehicle safely, paying attention to road and traffic conditions.
- ▶ Secure the vehicle against rolling away with the parking brake.
- ▶ Remove the rigid towing bar or towing rope.
- ▶ Remove the towing eye (▷ page 240).
- ▶ Switch off the hazard warning lamps.

## Electrical fuses

### Important safety notes

#### **WARNING**

If you manipulate, bridge or replace a faulty fuse with a fuse of a higher amperage, the electric cables could be overloaded. This may result in a fire. There is a risk of an accident and injury.

Always replace faulty fuses with specified new fuses of the correct amperage.

**!** Only use fuses that have been approved for smart vehicles and which have the correct fuse rating for the system concerned. Components or systems could otherwise be damaged.

The fuses in your vehicle serve to disconnect faulty circuits. If a fuse blows, all the components on the circuit and their functions will fail.

Blown fuses must be replaced with fuses of the same rating, which you can recognise by the colour and fuse rating. The fuse ratings are listed in the fuse allocation chart (▷ page 243).

If the newly inserted fuse also blows, have the cause traced and rectified at a qualified specialist workshop, e.g. a Mercedes-Benz Service Centre.

### Before replacing a fuse

- ▶ Secure the vehicle against rolling away (▷ page 138).
- ▶ Switch off all electrical consumers.
- ▶ Turn the key to position **0** in the ignition lock and remove it (▷ page 121). All indicator lamps in the instrument cluster must be off.

The fuses are located in various fuse boxes:

- Fuse box in the front area
- Fuse box in the glove compartment

### Fuse box in the front area

Pay attention to the "Important safety notes" (▷ page 241).

#### **WARNING**

If the windscreen wipers start to move when the service cover is open, you could become caught up in the wiper rods. There is a risk of injury.

Always switch off the windscreen wipers and the ignition before you open the service cover.

- ❗ Make sure that no moisture can enter the fuse box when the cover is open.
- ❗ When closing the cover, make sure that it is lying correctly on the fuse box. Moisture seeping in or dirt could otherwise impair the operation of the fuses.
- ▶ Make sure that the windscreen wipers are switched off.

>> Breakdown assistance.



- ▶ Open the service cover (▷ page 216). You can now see fuse box ①.

### Fuse box in the glove compartment

#### Fuse box

- ❗ Do not use a pointed object such as a screwdriver to open the cover in the dashboard. You could damage the dashboard or the cover.
- ❗ Make sure that no moisture can enter the fuse box when the cover is open.
- ❗ When closing the cover, make sure that it is lying correctly on the fuse box. Moisture seeping in or dirt could otherwise impair the operation of the fuses.

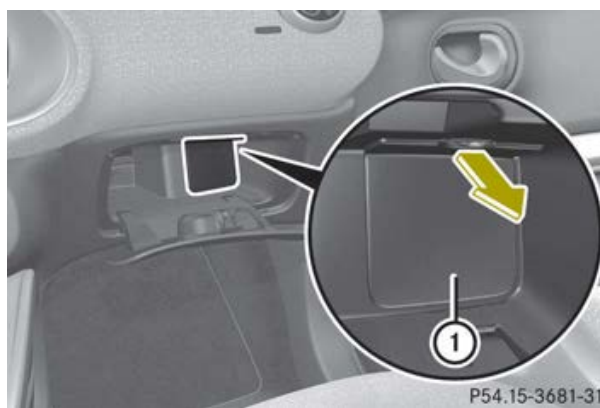

- ▶ Open the front-passenger door.
- ▶ **Vehicles with lockable glove compartment:** open the glove compartment.
- ▶ **To open:** open cover ① in the direction of the arrow.
- ▶ **To close:** insert and fold in cover ① until it engages.
- ▶ **Vehicles with lockable glove compartment:** close the glove compartment.

## Fuse allocation

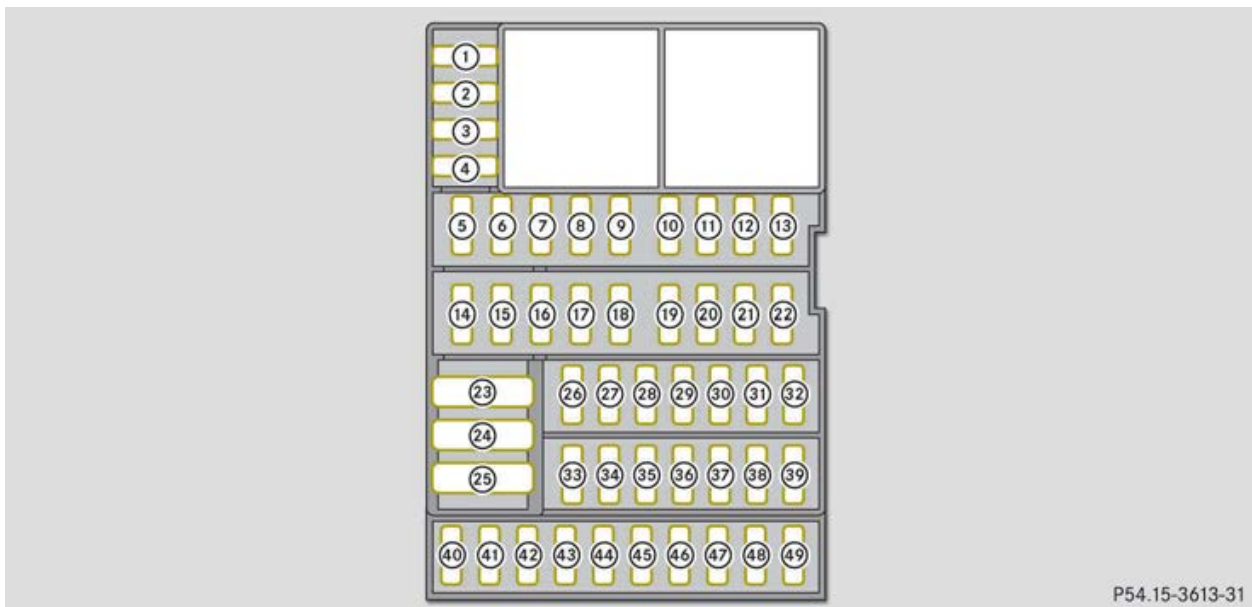

No.	Consumer	Current	Colour coding
1	Starter motor	5 A	Brown
2	Power steering control unit	5 A	Brown
3	Lighting control unit	5 A	Brown
4	Airbag	5 A	Brown
5	-	-	-
6	Instrument cluster	10 A	Red
7	Horn, alarm system	15 A	Blue
8	Control unit power supply	10 A	Red
9	Control unit power supply	10 A	Red
10	Central control unit	20 A	Yellow
11	Turn signals	15 A	Blue
12	Central control unit	10 A	Red
13	Central control unit	15 A	Blue
14	Power windows (anti-entrapment feature)	30 A	Green
15	esp®	5 A	Brown
16	Interior lighting	10 A	Red
17	Immobiliser	3 A	Violet

>> Breakdown assistance.

## &gt;&gt; Breakdown assistance.

No.	Consumer	Current	Colour coding
18	Electrical exterior mirror	5 A	Brown
19	Brake lamps	10 A	Red
20	Parking aid, headlamp settings, Lane Keeping Assist	15 A	Blue
21	Engine control unit	5 A	Brown
22	Rear window wiper	15 A	Blue
23	Starter motor	30 A	Green
24	Central locking	40 A	Orange
25	Front windscreen wipers	30 A	Green
26	Radio	20 A	Yellow
27	-	-	-
28	12 V socket, cigarette lighter	15 A	Blue
29	Power supply control unit	5 A	Brown
30	Horn	15 A	Blue
31	-	-	-
32	Central locking	15 A	Blue
33	Tail lamps, front foglamps, hazard warning lamp button, locking button, headlamp range control, power windows, licence plate lighting, radio, control unit for air-conditioning system, cruise control, limiter, parking aid button, program selector button, tailgate unlocking, Lane Keeping Assist camera, automatic start/stop system button	25 A	Cyan
34	Headlamps, daytime driving lamps	25 A	Cyan
35	Headlamps, daytime driving lamps	25 A	Cyan
36	-	-	-
37	-	-	-
38	-	-	-
39	-	-	-
40	-	-	-

No.	Consumer	Current	Colour coding
41	-	-	-
42	-	-	-
43	Exterior mirror heating	5 A	Brown
44	Anti-entrapment feature	25 A	Cyan
45	Transmission control unit	5 A	Brown
46	Radio amplifier	20 A	Yellow
47	-	-	-
48	-	-	-
49	-	-	-

>> Breakdown assistance.



Useful information .....	248
Important safety notes .....	248
Operation .....	248
Winter operation .....	250
Tyre pressure .....	251
Changing a wheel .....	255
Wheel and tyre combinations .....	260

### Useful information

- i** This Owner's Manual describes all models, series and optional equipment for your vehicle that were available at the time of going to press. Country-specific differences are possible. Note that your vehicle may not be fitted with all features described. This is also the case for systems and functions relevant to safety.
- i** Read the information on qualified specialist workshops: (▷ page 21).

### Important safety notes

#### WARNING

If wheels and tyres of the wrong size are used, the wheel brakes or suspension components may be damaged. There is a risk of an accident.

Always replace wheels and tyres with those that fulfil the specifications of the original part.

When replacing wheels, make sure to fit the correct:

- designation
- type

When replacing tyres, make sure to fit the correct:

- designation
- manufacturer
- type

#### Warning

A flat tyre severely impairs the driving, steering and braking characteristics of the vehicle. There is a risk of an accident. Do not drive with a flat tyre. Immediately replace the flat tyre with your spare wheel, or consult a qualified specialist workshop.

Accessories that are not approved for your vehicle by smart or that are not being used correctly can impair driving safety.

Before purchasing and using non-approved accessories, visit a qualified specialist workshop and enquire about:

- suitability
- legal stipulations
- factory recommendations

Information on dimensions and types of wheels and tyres for your vehicle (▷ page 260).

Information on air pressure for the tyres on your vehicle can be found:

- on the tyre pressure information label on the driver's side B-pillar
- under "Tyre pressure" (▷ page 251)

Modification work on the brake system and wheels is not permitted. The use of wheel spacers or brake dust shields is not permitted. This invalidates the general operating permit for the vehicle.

- i** Further information on wheels and tyres can be obtained at any qualified specialist workshop.

### Operation

#### Information on driving

- Check the tyre pressures when the vehicle is heavily laden and, if necessary, adjust before beginning your journey.
- While driving, pay attention to vibrations, noises and unusual handling characteristics, e.g. pulling to one side. This may indicate that the wheels or tyres are damaged. If you suspect that a tyre is defective, reduce your speed immediately. Stop the vehicle as soon as possible to check the wheels and tyres for damage. Hidden tyre damage could also be causing the unusual handling characteristics. If you find no signs of damage, have the tyres and wheels checked at a qualified specialist workshop.
- When parking your vehicle, make sure that the tyres do not get deformed by the

kerb or other obstacles. If it is necessary to drive over kerbs, speed humps or similar elevations, try to do so slowly and at an obtuse angle. Otherwise, the tyres, particularly the sidewalls, may be damaged.

### Regular checking of wheels and tyres

#### WARNING

Damaged tyres can cause tyre inflation pressure loss. As a result, you could lose control of your vehicle. There is a risk of accident.

Check the tyres regularly for signs of damage and replace any damaged tyres immediately.

Regularly check the wheels and tyres of your vehicle for damage, at least once a month, as well as after driving on rough roads. Damaged wheels can cause a loss of tyre pressure. Pay particular attention to damage such as:

- cuts in the tyres
- punctures in the tyres
- tears in the tyres
- bulges on tyres
- deformation or severe corrosion on wheels

Regularly check the tyre tread depth and the condition of the tread across the whole width of the tyre (▷ page 249). If necessary, turn the front wheels to full lock in order to inspect the inner side of the tyre surface. All wheels must have a valve cap to protect the valve against dirt and moisture. Do not fit anything onto the valve other than the standard valve cap or other valve caps approved for your vehicle by smart. Do not fit any other valve caps or systems, e.g. tyre pressure monitoring systems.

Regularly check the pressure of all the tyres, particularly prior to long trips.

Adjust the tyre pressure as necessary (▷ page 251).

The service life of tyres depends on various factors, including the following:

- driving style
- tyre pressure
- mileage

### Notes on tyre profile

#### WARNING

Insufficient tyre tread will reduce tyre traction. The tyre is no longer able to dissipate water. This means that on wet road surfaces, the risk of aquaplaning increases, in particular where speed is not adapted to suit the driving conditions. There is a risk of accident.

If the tyre pressure is too high or too low, tyres may exhibit different levels of wear at different locations on the tyre tread. Thus, you should regularly check the tread depth and the condition of the tread across the entire width of all tyres.

Minimum tyre tread depth for:

- summer tyres: 3 mm
- M+S tyres: 4 mm

For safety reasons, replace the tyres before the legally prescribed limit for the minimum tyre tread depth is reached.

### Selecting, fitting and replacing tyres

#### WARNING

Exceeding the stated tyre load-bearing capacity and the approved maximum speed could lead to tyre damage or the tyre bursting. There is a risk of accident.

Therefore, only use tyre types and sizes approved for your vehicle model. Observe the tyre load rating and speed rating required for your vehicle.

Pay special attention to the country-specific requirements for tyre approval. These requirements can stipulate a specific tyre type for your vehicle. Furthermore, the use of certain tyre types in certain regions and areas of operation can be highly beneficial. You can find further information regarding tyres at specialist tyre retailers, at qualified specialist workshops or at any smart centre.

- Only fit tyres and wheels of the same type and make.

Exception: it is permissible to fit a different type or make in the event of a flat tyre.

- Only fit tyres of the correct size onto the wheels.
- Run in new tyres at moderate speeds for the first 100 km. They only reach their full performance after this distance.
- Do not drive with tyres which have too little tread depth. This otherwise significantly reduces the traction on wet roads (aquaplaning).
- Replace the tyres after six years at the latest, regardless of wear.

## Winter operation

### General notes

Have your vehicle winterproofed at a qualified specialist workshop at the onset of winter.

Observe the notes in the "Changing a wheel" section (▷ page 255).

### Driving with summer tyres

At temperatures below +7 °C, summer tyres lose elasticity and therefore traction and braking power. Change the tyres on your vehicle to M+S tyres. Using summer tyres at very cold temperatures could cause tears to form, thereby damaging the tyres perma-

nently. smart cannot accept responsibility for this type of damage.

#### WARNING

Damaged tyres can cause tyre inflation pressure loss. As a result, you could lose control of your vehicle. There is a risk of accident.

Check the tyres regularly for signs of damage and replace any damaged tyres immediately.

### M+S tyres

#### WARNING

M+S tyres with a tyre tread depth of less than 4 mm are not suitable for use in winter as they do not provide sufficient traction. There is a risk of accident.

M+S tyres with a tread depth of less than 4 mm must be replaced.

At temperatures below +7 °C use winter tyres marked with M+S.

Only winter tyres bearing the  snowflake symbol in addition to the M+S marking provide the best possible grip in wintry road conditions. Only these tyres will allow driving safety systems such as ABS and ESP® to function optimally in winter. These tyres have been developed specifically for driving in snow.

Use M+S tyres of the same make and tread on all wheels to maintain safe handling characteristics.

Always observe the maximum permissible speed specified for the M+S tyres you have fitted. Therefore, only use tyre types and sizes approved for smart. Observe the tyre load rating and speed rating required for smart.

Tyres with a specified direction of rotation have additional benefits, e.g. if there is a risk of aquaplaning. These advantages can only be gained if the tyres are fitted

corresponding to the direction of rotation.

An arrow on the sidewall of the tyre indicates its correct direction of rotation.

If you fit M+S tyres that have a lower maximum permissible speed than that of the vehicle, affix an appropriate warning sign in the driver's field of vision. This can be obtained at a qualified specialist workshop.

Under these circumstances, you should also use the speed limiter to restrict the maximum speed of the vehicle so that it does not exceed the maximum permissible speed for the M+S tyres (▷ page 147).

When you have fitted the M+S tyres:

- ▶ Check the tyre pressures (▷ page 251).
- ▶ Restart the tyre pressure monitor (vehicles with black and white display) (▷ page 254).
- ▶ Restart the tyre pressure monitor (vehicles with colour display) (▷ page 254).

### Snow chains

#### WARNING

If you have fitted snow chains to the front wheels, they may scrape against the vehicle body or chassis components. This could cause damage to the vehicle or the tyres. There is a risk of an accident.

To avoid hazardous situations:

- never fit snow chains on the front wheels
- fit snow chains to the rear wheels in pairs.

**!** **Vehicles with steel wheels:** if you fit snow chains on steel wheels, you may damage the hub caps. Remove the hub caps from the relevant wheels before fitting the snow chains.

smart recommends that you only use snow chains that have been specially approved for smart. For more information, please

contact the smart centre or a qualified specialist workshop.

If you intend to fit snow chains, please bear the following points in mind:

- snow chains cannot be fitted to all wheel-tyre combinations. Permissible wheel-tyre combinations (▷ page 260).
- only use snow chains when the road surface is completely snow-covered. Remove the snow chains as soon as possible when you come to a road that is not snow-covered.
- local regulations may restrict the use of snow chains. Observe the appropriate regulations if you wish to fit snow chains.
- do not exceed the maximum permissible speed of 50 km/h.

### Tyre pressure

#### Tyre pressure specifications

#### WARNING

Underinflated or overinflated tyres pose the following risks:

- the tyres may burst, especially as the load and vehicle speed increase.
- the tyres may wear excessively and/or unevenly, which may greatly impair tyre traction.
- the driving characteristics, as well as steering and braking, may be greatly impaired.

There is a risk of an accident.

Observe the recommended tyre pressure and check the tyre pressure of all the tyres:

- at least every two weeks
- when the load changes
- before embarking on a longer journey
- for changed operating conditions, e.g. off-road driving

If necessary, correct the tyre pressure.

**⚠ WARNING**

If you mount unsuitable accessories onto tyre valves, the tyre valves may be overloaded and malfunction, which can cause tyre pressure loss. Aftermarket tyre pressure monitoring systems will cause the tyre valve to remain open. This can also result in tyre pressure loss. There is a risk of an accident.

Only screw standard valve caps or valve caps specifically approved by smart for your vehicle onto the tyre valve.

**⚠ WARNING**

If the tyre pressure drops repeatedly, the wheel, valve or tyre may be damaged. Tyre pressure that is too low may result in a tyre blow-out. There is a risk of accident.

- Check the tyre for foreign objects.
- Check whether the wheel is losing air or the valve is leaking.



If you are unable to rectify the damage, contact a qualified specialist workshop.

**🌿 Environmental note**

Check the tyre pressure regularly, at least every 14 days.

You will find a table with the recommended tyre pressure on the tyre pressure information label on the driver's side B-pillar. The tyre pressure information label may also state tyre pressures for different load conditions. These are defined in the table as different numbers of passengers and amounts of luggage. The actual number of seats may vary; for more information, please refer to the vehicle's registration documents.

If tyre sizes are not specified, the tyre pressures stated on the tyre pressure information label apply for all tyres approved for this vehicle.

 	
	
165/65/15 81T 185/50/16 81H	2,0 bar 29 psi
185/60/15 84H 205/45/16 83H	2,5 bar 36 psi
99090 3260 R	

P40.00-2252-31

If a tyre size precedes a tyre pressure, the following tyre pressure information is only valid for that tyre size.

Use a suitable pressure gauge to check the tyre pressure. The outer appearance of a tyre does not permit any reliable conclusion about the tyre pressure.

If possible, only correct tyre pressures when the tyres are cold.

The tyres are cold:

- if the vehicle has been parked with the tyres out of direct sunlight for at least three hours and
- if the vehicle has not been driven further than 2 km

Depending on the ambient temperature, the speed at which you are driving and the load on the tyres, the tyre temperature and thus the tyre pressure change by approximately: 10 kPa per 10 °C (0.1 bar/1.5 psi). Take this into account when checking the pressure of warm tyres. Only correct the tyre pressure if it is too low for the current operating conditions.

Driving with tyre pressure that is too high or too low can:

- shorten the service life of the tyres
- cause increased tyre damage
- have a negative effect on handling characteristics and thus the driving safety (e.g. aquaplaning)

## Tyre pressure monitor

### General notes

If a tyre pressure monitor system is fitted, the vehicle's wheels have sensors fitted that monitor the tyre pressures in all four tyres. The tyre pressure monitor warns you if the pressure drops in one or more of the tyres. The tyre pressure monitor only functions if the corresponding sensors are fitted to all wheels.

### Important safety notes

It is the driver's responsibility to set the tyre pressure to the recommended cold tyre pressure suitable for the operating situation (▷ page 251). Note that the correct tyre pressure for the current operating situation must first be taught-in to the tyre pressure monitor. If there is a substantial loss of pressure, the warning threshold for the warning message is aligned to the reference values taught-in. Restart the tyre pressure monitor after adjusting to the cold tyre pressure. The current pressures are saved as new reference values. This will ensure that a warning message will only appear if the tyre pressure drops significantly.

The tyre pressure monitor does not warn you of an incorrectly set tyre pressure. Observe the notes on the recommended tyre pressure (▷ page 251).

The tyre pressure monitor is not able to warn you of a sudden loss of pressure, e.g. if the tyre is penetrated by a foreign object. In the event of a sudden loss of pressure, bring the vehicle to a halt by braking carefully. Avoid abrupt steering manoeuvres.

The tyre pressure monitor has a yellow warning lamp in the instrument cluster for indicating a pressure loss or malfunction. Depending on how the warning lamp flashes or lights up, a tyre pressure that is too low or a malfunction in the tyre pressure monitor is indicated:

- if the warning lamp is lit continuously, the tyre pressure on one or more tyres is significantly too low. The tyre pressure monitor is not malfunctioning.
- if the warning lamp flashes for around a minute and then remains lit constantly, the tyre pressure monitor is malfunctioning.

**i On-board computer with colour display:** In addition to the warning lamp, a message appears in the display. Observe the information on display messages (▷ page 184).

If the tyre pressure monitor is malfunctioning, it may take up to ten minutes for the tyre pressure warning lamp to inform you of the malfunction. The malfunction will be indicated first by the tyre pressure warning lamp flashing for approximately one minute and then remaining lit. When the fault has been rectified, the tyre pressure warning lamp goes out after you have driven for a few minutes.

The operation of the tyre pressure monitor can be affected by interference from radio transmitting equipment (e.g. cordless headphones, two-way radios) that may be being operated in or near the vehicle.

### Tyre pressure monitor warning (on-board computer with black and white display)

If the tyre pressure monitor detects a pressure loss in one or more tyres, the yellow warning light in the tyre pressure monitor lights up. If the tyre pressure in one or more tyres suddenly sinks, a warning tone also sounds.

Observe the instructions and safety notes for the indicator and warning lamps in the instrument cluster in the "Tyres" section (▷ page 198).

### **Tyre pressure monitor warning messages (on-board computer with colour display)**

If the tyre pressure monitor detects a pressure loss in one or more tyres, a warning message is shown in the display. The yellow warning light in the tyre pressure monitor lights up. For certain display messages a warning tone also sounds.

- If the **Correct tyre pressure** message appears in the display, the tyre pressure in at least one tyre is too low. Correct the tyre pressure at the next opportunity.
- If the **Tyre pressure Caution tyre malfunction** message appears in the display, the tyre pressure in one or more tyres has dropped suddenly and the tyres must be checked.

Observe the instructions and safety notes for the display messages in the "Tyres" section (▷ page 184) and the indicator and warning lamps in the instrument cluster in the "Tyres" section (▷ page 198).

### **Restarting the tyre pressure monitor**

When you restart the tyre pressure monitor, all existing warning messages are deleted and the warning lamps go out. The monitor uses the currently set tyre pressures as the reference values for monitoring. In most cases, the tyre pressure monitor will automatically detect the new reference values after you have changed the tyre pressure. However, you can also define reference values manually as described here. The tyre pressure monitor then monitors the new tyre pressure values.



- ▶ Using the tyre pressure information label on the driver's side B-pillar, ensure that the tyre pressure of all four

wheels is correctly set for the operating conditions.

Also observe the notes in the section on tyre pressures (▷ page 251).

### **On-board computer with a monochrome display**

#### **▶ To restart the tyre pressure monitor:**

press the  button on the multifunction lever repeatedly until the **SET**  symbols are displayed.



- ▶ Press and hold the **OK** button on the multifunction lever.



The **SET**  symbols flash for about 5 seconds. The symbols then both remain lit.

The tyre pressure monitor is restarted.

### **On-board computer with a colour display**



#### **▶ To restart the tyre pressure monitor:**

press the  or  button on the steering wheel to select the **Settings** menu and press **OK** on the steering wheel to confirm.

- ▶ Press the  or  button to select the **Tyre pressure monitor** submenu and confirm with **OK**.

The **Tyre pressure monitor Adopt current pressures as new reference values?** message appears in the display.

#### **If you wish to confirm the restart:**

- ▶ Press the  or  button to select **yes** and press the **OK** button to confirm. The **Tyre pressure monitor restarted** message appears in the display.



- ▶ Press **OK** to confirm.

After a short while, the message is also hidden without pressing the **OK** button.

After you have driven for a few minutes, the system checks whether the current tyre pressures are within the specified range. The new tyre pressures are then accepted as reference values and monitored.

**i** If the **Tyre pressure monitor restarted** message does not appear after approximately 5 seconds, the restart was not successful. If this occurs, repeat the restart.

**If you wish to cancel the restart:**

- ▶ Press the  or  button to select **no** and press the  button to confirm. The tyre pressure values stored at the last restart will continue to be monitored.

**Radio type approval for the tyre pressure monitor**

Country	Radio type approval number
Argentina	MW2433A H-12337 GG4 H-12338
Brazil	2770-12-8001 Model: MW2433A 0381-13-8001 Model: GG4
Abu Dhabi Dubai	TRA, Registered-NO ER0092100/12 TRA, Registered-NO ER0099792/12 TRA, Registered-NO ER0076990/11 Dealer-NO: DA0047074/10

Country	Radio type approval number
Jordan	Model: Gen Alpha Wal 2 TPMS transmitter Type Approval Number: TRC/LPD/2012/114 Model: Gen Gamma Gen 4 433.92 MHz. Type Approval Number: TRC/LPD/2012/190 Model: Corax 3 MRXMC34MA4 Type Approval Number: TRC/LPD/2011/158 Type Number: LPD
Morocco	MR7319 ANRT 2012/ 11/07/2012 MR7672 ANRT 2012/ 23/11/2012 MR6706 ANRT 2011
Moldova	1024
Philippines	No: ESD-1206394C No: ESD-1306871C
Serbia	I 011 12
Singapore	Compliance with IDA Standard DA- 103365
South Africa	TA-2012/719 TA-2012/1540 TA-2011/1370

**>> Wheels and tyres.**

**Changing a wheel**

**Flat tyres**

You can find information on what to do in the event of flat tyre in the "Flat tyre" section (▷ page 229).

**Interchanging the wheels**

 **WARNING**

Never interchange the front and rear wheels as they have different dimensions, e.g. size, offset etc. Otherwise, there could be a

negative effect on the road holding and you could endanger yourself or others.

**!** On vehicles fitted with a tyre pressure monitor, electronic components are located in the wheel.

Tyre-fitting tools should not be applied in the area of the valve, as this could damage the electronic components.

Only have tyres changed at a qualified specialist workshop.

Various types of steel wheel can be fitted on your vehicle. Some steel wheels have a red mark in the hub cap area. The hub cap has to be removed to see the red mark, see "Raising the vehicle" in the "Wheel change" section (▷ page 257). When changing the wheels, always fit wheels of the same type on all axles.

Interchanging the front and rear wheels of differing dimensions can render the general operating permit invalid.

Always pay attention to the instructions and safety notes when changing a wheel (▷ page 255).

The wear patterns on the front and rear tyres differ, depending on the operating conditions. Front tyres typically wear more on the shoulders and the rear tyres in the centre.

Clean the contact surfaces of the wheel and the brake disc thoroughly every time a wheel is interchanged. Check the tyre pressure and reactivate the tyre pressure monitor if necessary.

### Direction of rotation

Tyres with a specified direction of rotation have additional benefits, e.g. if there is a risk of aquaplaning. These advantages can only be gained if the tyres are fitted corresponding to the direction of rotation.

An arrow on the sidewall of the tyre indicates its correct direction of rotation.

### Storing wheels

Store wheels in a cool, dry and preferably dark place if they are not being used. Protect the tyres against oil, grease, petrol and diesel.

### Fitting a wheel

#### Preparing the vehicle

- ▶ Make sure that you have the appropriate tyre-changing tools. For further information enquire at any smart centre.
- i** Necessary tyre-changing tools can include, for example:
  - jack
  - wheel chock
  - wheel wrench
- ▶ Stop the vehicle on solid, non-slippery and level ground.
- ▶ Apply the parking brake (▷ page 139).
- ▶ Bring the front wheels into the straight-ahead position.
- ▶ Depress the clutch pedal fully and engage first or reverse gear.
- ▶ Switch off the engine.
- ▶ Remove the key from the ignition lock.
- ▶ Also secure the vehicle against rolling away.

#### Securing the vehicle against rolling away



- ▶ **On level ground:** place chocks or other suitable items under the front and rear of the wheel that is diagonally opposite the wheel you wish to change.



- ▶ **On light downhill gradients:** place chocks or other suitable items in front of the wheels of the front and rear axle.

### Raising the vehicle

#### **WARNING**

If you do not position the jack correctly at the appropriate jacking point of the vehicle, the jack could tip over with the vehicle raised. There is a risk of injury.

Only position the jack at the appropriate jacking point of the vehicle. The base of the jack must be positioned vertically, directly under the jacking point of the vehicle.

### Observe the following when raising the vehicle:

- make sure you have a suitable jack and wheel wrench. If the jack is used incorrectly, it could tip over while the vehicle is raised.  
For further information enquire at any smart centre.
- the jack is designed only to raise and hold the vehicle for a short time while a wheel is being changed. It is not suited for performing maintenance work under the vehicle.

- avoid changing the wheel on uphill and downhill slopes.
- before raising the vehicle, secure it from rolling away by applying the parking brake and inserting wheel chocks. Never disengage the parking brake while the vehicle is raised.
- the jack must be placed on a firm, flat and non-slip surface. On a loose surface, a large, flat load-bearing underlay must be used. On a slippery surface, a non-slip underlay must be used, e.g. rubber mats.
- do not use wooden blocks or similar objects as a jack underlay. Otherwise, the jack will not be able to achieve its load-bearing capacity due to the restricted height.
- make sure that the distance between the underside of the tyres and the ground does not exceed 3 cm.
- never place your hands or feet under the raised vehicle.
- do not lie under the vehicle.
- do not start the engine when the vehicle is raised.
- do not open or close a door or the tailgate while the vehicle is raised.
- make sure that no persons are present in the vehicle when the vehicle is raised.

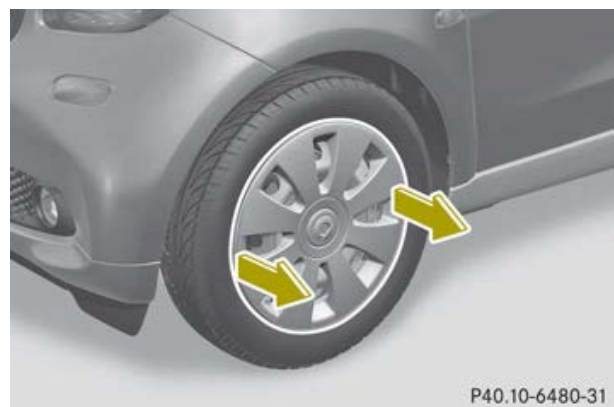

Steel wheel with wheel trim

- ▶ **Vehicles with steel wheels and hub caps:** carefully reach into two of the hub cap openings and remove the hub cap.



P40.10-6481-31

Steel wheel with hub cap

- ▶ **Vehicles with steel wheels and hub caps:** remove the hub cap.

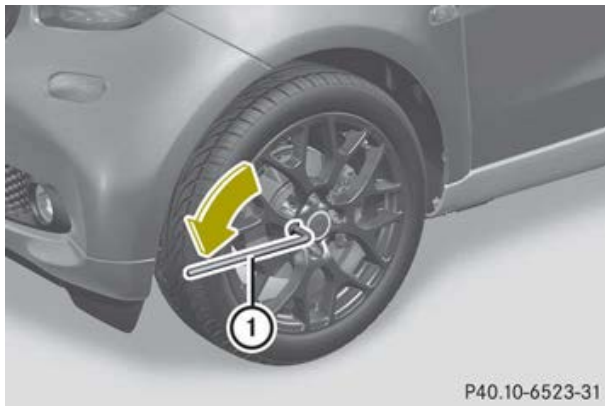

P40.10-6523-31

- ▶ Using wheel wrench (1), loosen the bolts on the wheel you wish to change by about one full turn. Do not unscrew the bolts completely.

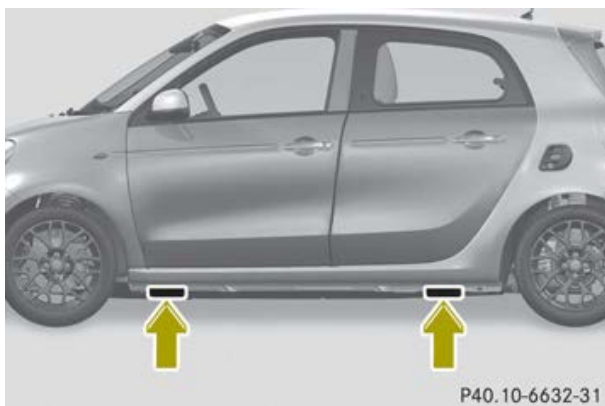

P40.10-6632-31

The vehicle may only be raised at the designated jacking points on the sill.

The jacking points are located just behind the front wheel arches and just in front of the rear wheel arches (arrows). You can

identify the jacking points by the triangular indentations on the sill.

To avoid damage, position the jack centrally under the triangular indentations.

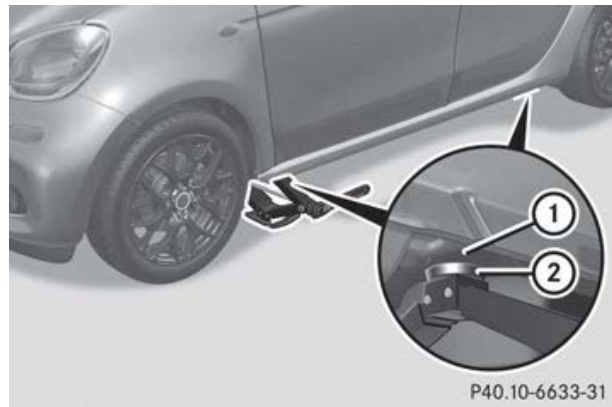

P40.10-6633-31

- ▶ Position jack (2) centrally under the triangular indentations at jacking points on the sill (1).

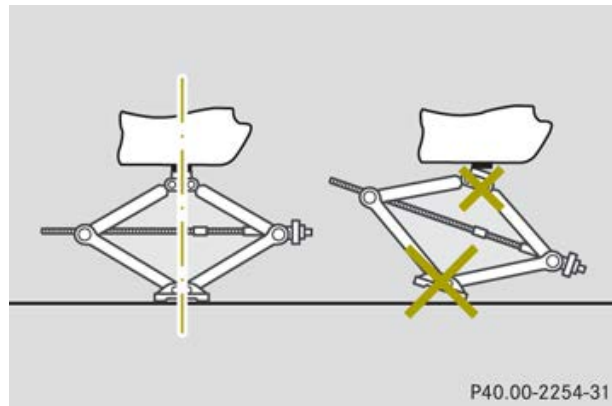

P40.00-2254-31

Example

- ▶ Make sure that the base of the jack is positioned vertically under the jacking point.
- ▶ Raise the vehicle with jack (2) until the tyre is at most 3 cm off the ground.

### Removing a wheel

**!** Do not place wheel bolts in sand or dirt. The threads of the wheel bolts and wheel hubs could otherwise be damaged when the bolts are tightened.

- ▶ Unscrew the wheel bolts.
- ▶ Remove the wheel.

## Fitting a new wheel

### WARNING

Oiled or greased wheel bolts or damaged wheel bolts/hub threads can cause the wheel bolts to come loose. As a result, you could lose a wheel while driving. There is a risk of accident.

Never oil or grease wheel bolts. In the event of damage to the threads, contact a qualified specialist workshop immediately. Have the damaged wheel bolts or hub threads replaced/renewed. Do not continue driving.

### WARNING

If you tighten the wheel bolts or wheel nuts when the vehicle is raised, the jack could tip over. There is a risk of injury.

Only tighten the wheel bolts or wheel nuts when the vehicle is on the ground.

Always pay attention to the instructions and safety notices in "Changing a wheel" (▷ page 255).

Only use wheel bolts that are designed for the wheel and the vehicle. For safety reasons, smart recommends that you only use wheel bolts which have been approved for smart vehicles and the respective wheel.

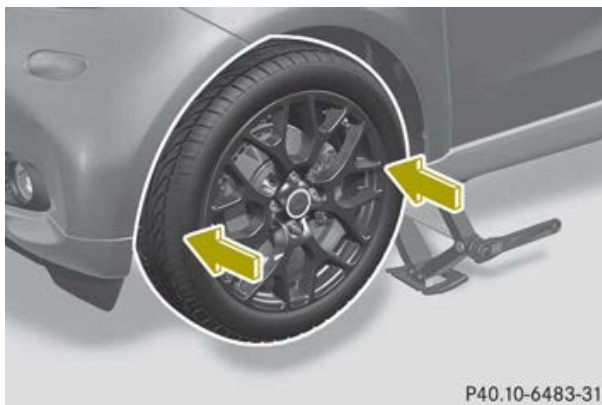

- ▶ Clean the wheel and wheel hub contact surfaces.
- ▶ Place the new wheel on the wheel hub and push it on.

- ▶ Tighten the wheel bolts until they are finger-tight.

## Lowering the vehicle

### WARNING

The wheels could work loose if the wheel nuts and bolts are not tightened to the specified tightening torque. There is a risk of accident.

Have the tightening torque immediately checked at a qualified specialist workshop after a wheel is changed.

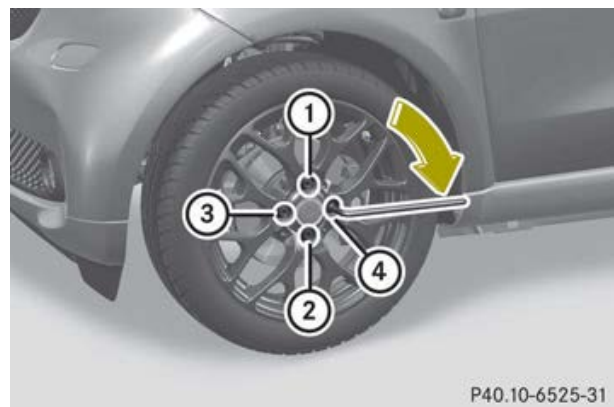

- ▶ Lower the vehicle until it is once again standing firmly on the ground.
- ▶ Place the jack to one side.
- ▶ Tighten the wheel bolts evenly in a crosswise pattern in the sequence indicated (① to ④). The tightening torque must be **105 Nm**.
- ▶ Check the air pressure of the newly fitted wheel and adjust accordingly. Observe the recommended tyre pressure (▷ page 251).
- i** Vehicles with tyre pressure control system: all fitted wheels must be equipped with functioning sensors.

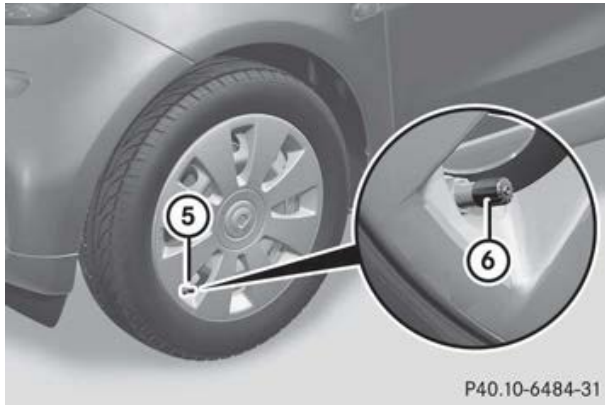

Steel wheel with wheel trim

- ▶ **Vehicles with steel wheels and hub caps:** fit hub cap ⑤ so that tyre valve ⑥ is not trapped.
- ▶ Press the hub cap ⑤ evenly onto the wheel with both hands.
- ▶ Check to make sure the hub cap ⑤ is seated safely on the wheel.
- ▶ **Vehicles with steel wheels and hub caps:** fit the hub cap.

### Wheel and tyre combinations

#### General notes

❗ For safety reasons, smart recommends that you only use tyres and wheels which have been specifically approved by smart for your vehicle. These are specially adapted to the control systems, such as ABS or ESP®.

Only use tyres and wheels specifically tested and approved by smart. Certain characteristics, e.g. handling, vehicle noise emissions or fuel consumption, may otherwise be adversely affected. In addition, when driving with a load, dimensional variations and different tyre deformation characteristics could cause the tyres to make contact with the bodywork and axle components. This could result in damage to the tyres or the vehicle.

smart accepts no liability for damage resulting from the use of tyres or wheels other than those tested and approved.

Information on wheels and tyres can be obtained at a qualified specialist workshop, e.g. a smart centre.

❗ Retreaded tyres have not been tested by smart and the fitment of such tyres is not recommended. Previous damage sustained by the tyres (before the retreading process) cannot always be recognised. As a result, smart cannot guarantee vehicle safety if retreaded tyres are fitted.

❗ Large wheels: the lower the section width for a certain wheel size, the lower the ride comfort is on poor road surfaces. Roll comfort and suspension comfort are reduced and the risk of damage to the wheels and tyres as a result of driving over obstacles increases.

Overview of abbreviations used in the following tyre tables:

- BA: both axles
- FA: front axle
- RA: rear axle

You will find a table with the recommended tyre pressures on the tyre pressure information label on the driver's side B-pillar. For further information on tyre pressure, see (▷ page 251). Check tyre pressures regularly and only when the tyres are cold.

Notes on the vehicle equipment – always fit the vehicle:

- with tyres of the same size on a given axle (left/right)
- with the same type of tyres on all wheels at a given time (summer tyres, winter tyres)

Exception: it is permissible to fit a different type or make in the event of a flat tyre.

i Not all wheel/tyre combinations can be fitted at the factory in all countries.



**Tyres****smart forfour 45 kW****Summer tyres****R 15**

<b>Tyres</b>	<b>Wheels</b>
FA: 165/65 R15 81 T <sup>5</sup> RA: 185/60 R15 84 T	Steel wheels: FA: 5.0 J x 15 H2 ET 32 RA: 5.5 J x 15 H2 ET 42 Light-alloy wheels: FA: 5.0 J x 15 CH ET 32 RA: 5.5 J x 15 CH ET 42
FA: 165/65 R15 81 H <sup>5</sup> RA: 185/60 R15 84 H	Steel wheels: FA: 5.0 J x 15 H2 ET 32 RA: 5.5 J x 15 H2 ET 42 Light-alloy wheels: FA: 5.0 J x 15 CH ET 32 RA: 5.5 J x 15 CH ET 42

**R 16**

<b>Tyres</b>	<b>Wheels</b>
FA: 185/50 R16 81 H <sup>5</sup> RA: 205/45 R16 83 H <sup>5</sup>	Light-alloy wheels: FA: 6.0 J x 16 CH ET 44 RA: 6.5 J x 16 CH ET 40

**Winter tyres****R 15**

<b>Tyres</b>	<b>Wheels</b>
FA: 165/65 R15 81 T M+S  <sup>5</sup> RA: 185/60 R15 84 T M+S 	Steel wheels: FA: 5.0 J x 15 H2 ET 32 RA: 5.5 J x 15 H2 ET 42 Light-alloy wheels: FA: 5.0 J x 15 CH ET 32 RA: 5.5 J x 15 CH ET 42

<sup>5</sup> Use of snow chains not permitted. Observe the notes in the section "Snow chains".

## smart forfour 52 kW

## Summer tyres

## R 15



Tyres	Wheels
FA: 165/65 R15 81 T <sup>5</sup> RA: 185/60 R15 84 T	Steel wheels: FA: 5.0 J x 15 H2 ET 32 RA: 5.5 J x 15 H2 ET 42 Light-alloy wheels: FA: 5.0 J x 15 CH ET 32 RA: 5.5 J x 15 CH ET 42
FA: 165/65 R15 81 H <sup>5</sup> RA: 185/60 R15 84 H	Steel wheels: FA: 5.0 J x 15 H2 ET 32 RA: 5.5 J x 15 H2 ET 42 Light-alloy wheels: FA: 5.0 J x 15 CH ET 32 RA: 5.5 J x 15 CH ET 42

## R 16

Tyres	Wheels
FA: 185/50 R16 81 H <sup>5</sup> RA: 205/45 R16 83 H <sup>5</sup>	Light-alloy wheels: FA: 6.0 J x 16 CH ET 44 RA: 6.5 J x 16 CH ET 40

## Winter tyres

## R 15

Tyres	Wheels
FA: 165/65 R15 81 T M+S  <sup>5</sup> RA: 185/60 R15 84 T M+S 	Steel wheels: FA: 5.0 J x 15 H2 ET 32 RA: 5.5 J x 15 H2 ET 42 Light-alloy wheels: FA: 5.0 J x 15 CH ET 32 RA: 5.5 J x 15 CH ET 42

<sup>5</sup> Use of snow chains not permitted. Observe the notes in the section "Snow chains".

## smart forfour 66 kW Turbo

## Summer tyres

## R 15



Tyres	Wheels
FA: 165/65 R15 81 T <sup>5</sup> RA: 185/60 R15 84 T	Steel wheels: FA: 5.0 J x 15 H2 ET 32 RA: 5.5 J x 15 H2 ET 42 Light-alloy wheels: FA: 5.0 J x 15 CH ET 32 RA: 5.5 J x 15 CH ET 42
FA: 165/65 R15 81 H <sup>5</sup> RA: 185/60 R15 84 H	Steel wheels: FA: 5.0 J x 15 H2 ET 32 RA: 5.5 J x 15 H2 ET 42 Light-alloy wheels: FA: 5.0 J x 15 CH ET 32 RA: 5.5 J x 15 CH ET 42

## R 16

Tyres	Wheels
FA: 185/50 R16 81 H <sup>5</sup> RA: 205/45 R16 83 H <sup>5</sup>	Light-alloy wheels: FA: 6.0 J x 16 CH ET 44 RA: 6.5 J x 16 CH ET 40

## Winter tyres

## R 15

Tyres	Wheels
FA: 165/65 R15 81 T M+S  <sup>5</sup> RA: 185/60 R15 84 T M+S 	Steel wheels: FA: 5.0 J x 15 H2 ET 32 RA: 5.5 J x 15 H2 ET 42 Light-alloy wheels: FA: 5.0 J x 15 CH ET 32 RA: 5.5 J x 15 CH ET 42

<sup>5</sup> Use of snow chains not permitted. Observe the notes in the section "Snow chains".



Useful information .....	266
Information on technical data .....	266
Vehicle electronics .....	266
Identification plates .....	267
Service products and capacities .....	268
Vehicle data .....	273

### Useful information

- i** This Owner's Manual describes all models, series and optional equipment for your vehicle that were available at the time of going to press. Country-specific differences are possible. Note that your vehicle may not be fitted with all features described. This is also the case for systems and functions relevant to safety.
- i** Read the information on qualified specialist workshops: (▷ page 21).

### Information on technical data

#### General notes

You can find current technical data on the Internet on our smart homepage.

- i** The technical data was determined in accordance with EC Directives. All data applies to the vehicle's standard equipment. The data may therefore differ for vehicles with optional equipment. For further information enquire at any smart centre.

### Vehicle electronics

#### Tampering with the engine electronics

- !** Only have work carried out on the engine electronics and its associated parts, such as control units, sensors, actuating components and connector leads, at a qualified specialist workshop. Vehicle components may otherwise wear more quickly and the vehicle's operating permit may be invalidated.

#### Retrofitting two-way radios and mobile phones (RF transmitters)

##### WARNING

If RF transmitters are tampered with or not properly retrofitted, the electromagnetic radiation they emit can interfere with the vehicle electronics. This may jeopardise the operational safety of the vehicle. There is a risk of an accident.

You should have all work on electrical and electronic components carried out at a qualified specialist workshop.

##### WARNING

If you operate RF transmitters incorrectly in the vehicle, the electromagnetic radiation could interfere with the vehicle electronics, e.g.:

- if the RF transmitter is not connected to an exterior aerial
- the exterior aerial has been fitted incorrectly or is not a low-reflection type

This could jeopardise the operating safety of the vehicle. There is a risk of an accident.

Have the low-reflection exterior aerial fitted at a qualified specialist workshop. When operating RF transmitters in the vehicle, always connect them to the low-reflection exterior aerial.

- !** The operating permit may be invalidated if the instructions for installation and use of RF transmitters are not observed.

In particular, the following conditions must be complied with:

- only approved wavebands may be used.
- observe the maximum permissible output in these wavebands.
- only approved aerial positions may be used.

Excessive levels of electromagnetic radiation may cause damage to your health and to the health of others. The use of an exterior aerial takes into consideration the scientific discussion surrounding the possible health risk posed by electromagnetic fields.

The following aerial positions may be used if RF transmitters have been properly installed:

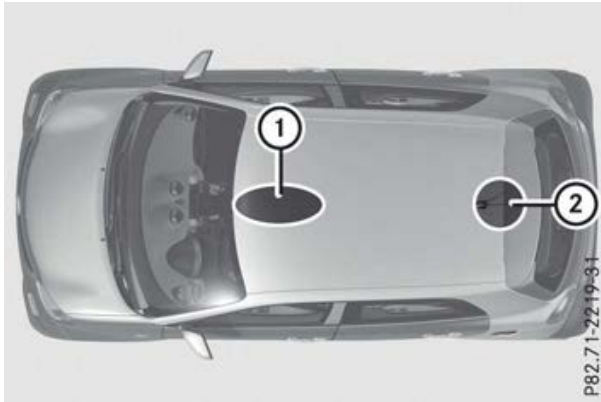

Approved aerial positions

- ① Front roof area
- ② Rear roof area

**i** On vehicles with a folding top, fitting an aerial to the front roof area is not permitted.

Use Technical Specification ISO/TS 21609 (Road Vehicles – "EMC guidelines for fitting aftermarket radio frequency transmitting equipment") when retrofitting RF (radio frequency) transmitters. Comply with the legal requirements for add-on parts.

If your vehicle has fittings for two-way radio equipment, use the power supply or aerial connections intended for use with the basic wiring. Be sure to observe the manufacturer's additional instructions when installing.

Deviations with respect to wavebands, maximum transmission outputs or aerial positions must be approved by Mercedes-Benz.

The maximum transmission output (PEAK) at the base of the aerial must not exceed the following values:

Waveband	Maximum transmission output
Tetra 380 - 410 MHz	20 W
Mobile communications generation 2G/3G/4G	6 W

The following can be used in the vehicle without restrictions:

- RF transmitters with a maximum transmission output of up to 100 mW
- Mobile phones (2G/3G/4G)

There are no restrictions when positioning the aerial on the outside of the vehicle for the following wavebands:

- Tetra
- Mobile communications (2G/3G/4G)

### Identification plates

#### Vehicle identification plate with vehicle identification number (VIN)

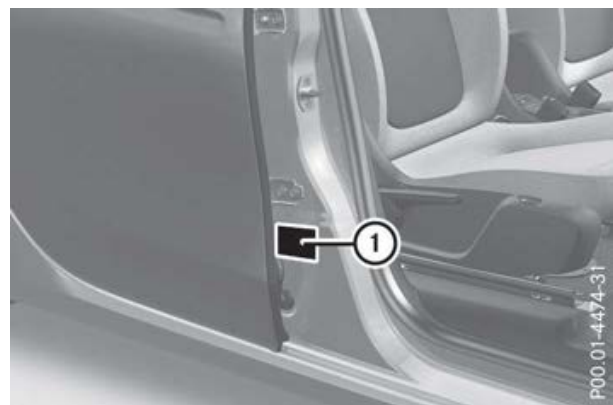

- ▶ Open the front right-hand door. You will see vehicle identification plate ①.

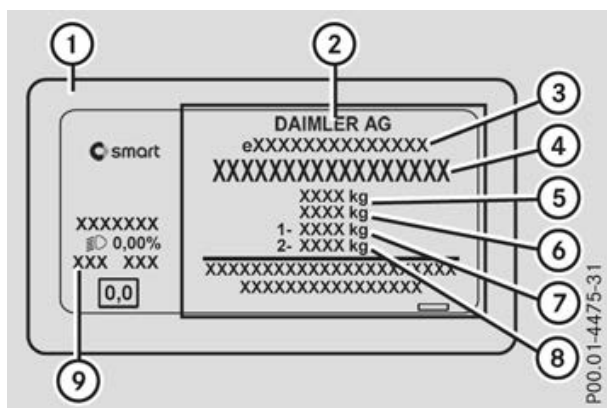

Example: vehicle identification plate

- ① Vehicle identification plate
- ② Vehicle manufacturer
- ③ EU type approval number
- ④ Vehicle identification number (VIN)
- ⑤ Maximum permissible gross vehicle weight
- ⑥ Permissible gross vehicle weight of the vehicle combination
- ⑦ Maximum permissible front axle load
- ⑧ Maximum permissible rear axle load
- ⑨ Paint code

**i** The data shown on the vehicle identification plate is example data. This data is different for every vehicle and can deviate from the data shown here. You can find the data applicable to your vehicle on the vehicle's identification plate.

### Vehicle identification number (VIN)

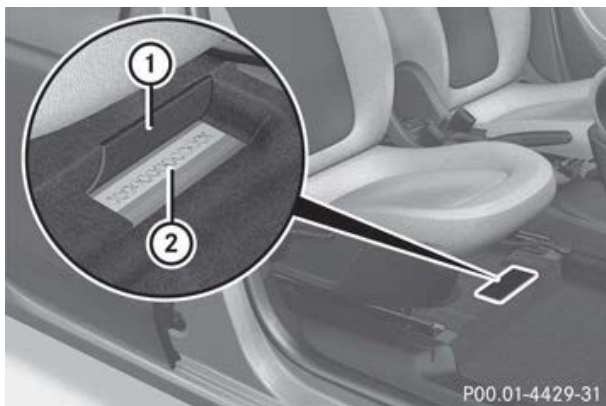

- ▶ Slide the right-hand front seat to its rearmost position.
- ▶ Fold up floor covering ① in front of the right-hand front seat. You will see VIN ②.

The VIN can also be found on the vehicle identification plate (▷ page 267).

### Engine number

The engine number is stamped onto the crankcase. You can obtain further information from any qualified specialist workshop.

### Service products and capacities

#### Important safety notes

#### **⚠ WARNING**

Service product can be poisonous and hazardous to health. There is a risk of injury. Observe the instructions on the respective original container when using, storing and disposing off service products. Always store service products in the sealed original container. Always keep service products out of the reach of children.

#### **♻ Environmental note**

Dispose of service products in an environmentally-responsible manner.

Service products include the following:

- Fuels
- Lubricants (e.g. engine oil, transmission oil)
- Coolant
- Brake fluid
- Windscreen washer fluid
- Climate control system refrigerant

Components and service products must be matched. smart recommends that you use products tested and approved by smart.

They are listed in this smart Owner's Manual in the appropriate section.

You can identify service products approved by Mercedes-Benz by the following inscriptions on the container:

- MB-Freigabe (e.g. MB-Freigabe 229.51)
- MB Approval (e.g. MB Approval 229.51)

Other designations or recommendations indicate a level of quality or a specification in accordance with an MB Sheet Number (e.g. MB 229.5). They have not necessarily been approved by Mercedes-Benz.

**i** For further information enquire at any smart centre.

## Fuel

### Important safety notes

#### WARNING

Fuel is highly flammable. If you handle fuel incorrectly, there is a risk of fire and explosion.

You must avoid fire, naked flames, creating sparks and smoking. Switch off the engine and, if applicable, the auxiliary heating before refuelling.

#### WARNING

Fuels are poisonous and hazardous to health. There is a danger of injury.

Do not swallow fuel or let it come into contact with skin, eyes or clothing. Do not inhale fuel vapours. Keep fuels out of the reach of children.

If you or others come into contact with fuel, observe the following:

- Wash the fuel off any affected areas of skin with water and soap immediately.
- If you get fuel in your eyes, rinse them thoroughly with clean water immediately. Seek immediate medical attention.

- If fuel is swallowed, seek immediate medical attention. Do not induce vomiting.
- Change any clothing that has come into contact with fuel immediately.

### Tank capacity

The total capacity of the fuel tank may vary, depending on the vehicle equipment.

Model	Total capacity
All models	28.0 l or 34.0 l

Model	Of which reserve fuel
All models	Approx. 5.0 l

### Petrol

#### Fuel grade

**!** Do not use diesel to refuel vehicles with a petrol engine. Do not switch on the ignition if you accidentally refuel with the wrong fuel. Otherwise, the fuel will enter the fuel system. Even small amounts of the wrong fuel can result in damage to the fuel system and the engine. Notify a qualified specialist workshop and have the fuel tank and fuel lines drained completely.

**!** Only refuel using premium-grade unleaded petrol with at least 95 ROZ/ 85 MOZ, that conforms to European standard EN 228 or E DIN 51626-1 or an equivalent specification.

Fuel of this specification can contain up to 10 % ethanol.

Fuel that does not conform to EN 228 or E DIN 51626-1 can lead to increased wear

and damage the engine and exhaust system.

**!** Only use the fuel recommended. Operating the vehicle with other fuels can lead to engine failure.

**!** Do not use the following:

- E85 (petrol with 85% ethanol)
- E100 (100% ethanol)
- M15 (petrol with 15% methanol)
- M30 (petrol with 30% methanol)
- M85 (petrol with 85% methanol)
- M100 (100% methanol)
- petrol with additives containing metal
- Diesel

Do not mix such fuels with the fuel recommended for your vehicle. Do not use additives. Engine failure may otherwise occur. This does not include cleaning additives for the removal and prevention of residue build-up. Petrol must only be mixed with cleaning additives recommended by smart, see "Additives". For further information enquire at any smart centre.

Usually you will find information about the fuel grade on the pump. If you cannot find the label on the petrol pump, ask the filling station staff.

**i** E10 fuel contains up to 10% bioethanol. Your vehicle is suitable for use with E10 fuel. You can refuel your vehicle using E10 fuel.

As a temporary measure, if the recommended fuel is not available, you may also use unleaded petrol with an octane rating of 91 RON/82 MON. This may reduce engine performance and increase fuel consumption. Avoid driving at full throttle and sudden acceleration. Never refuel using fuel with a lower RON/MON.

**i** In some countries, the available petrol may not be sufficiently low in sulphur.

This fuel can temporarily produce unpleasant odours, especially on short journeys. As soon as sulphur-free fuel (sulphur content < 10 ppm) is used for refuelling, the odours are reduced.

Information on refuelling (▷ page 136).

### Additives

**!** Operation of the engine with fuel additives added later can cause engine damage. Therefore, do not mix any fuel additives with the fuel. This does not include additives for the removal and prevention of residue build-up. Petrol must only be mixed with additives recommended by smart. Observe the instructions for use in the product description. For further information on recommended additives enquire at any smart centre.

smart recommends that you use fuel brands that have additives.

The quality of the fuel available in some countries may not be sufficient. Residue could build up in the injection system as a result. In this case, in consultation with a smart centre, the petrol may be mixed with the cleaning additive recommended by smart. You must observe the notes and mixing ratios specified on the container.

### Fuel consumption information

#### Environmental note

CO<sub>2</sub> (carbon dioxide) is the gas which scientists believe to be principally responsible for global warming (the greenhouse effect). Your vehicle's CO<sub>2</sub> emissions are directly related to fuel consumption and therefore depend on:

- efficient use of the fuel by the engine
- driving style
- other non-technical factors, such as environmental influences, road conditions or traffic flow

You can minimise your vehicle's CO<sub>2</sub> emissions by driving carefully and having it serviced regularly.

The vehicle will use more fuel than usual in the following situations:

- at very low outside temperatures
- in urban traffic
- on short journeys
- in mountainous terrain

**i** Only for certain countries: you can find the current consumption and emission values of your vehicle in the COC documents (EU CERTIFICATE OF CONFORMITY). These documents are delivered with your vehicle.

The consumption figures were in each case based on the currently applicable version:

- for vehicles that comply with or exceed the EURO 5 standard, in accordance with Regulation (EC) No. 715/2007

Deviations from these values may occur under normal operating conditions.

## Engine oil

### General notes

When handling engine oil, observe the important safety notes on service products (▷ page 268).

The quality of the engine oil is decisive for the function and service life of an engine. After extensive tests, Mercedes-Benz approves engine oils that correspond to the current technical standard. Therefore, only use engine oils approved by Mercedes-Benz.

Further information on tested and approved engine oils can be obtained from any smart centre. smart recommends that you have the oil change carried out at a qualified specialist workshop.

Mercedes-Benz approval is indicated on the oil container by the inscription "MB Approval" and the corresponding designation, e.g. MB Approval 229.51.

You can call up an overview of approved engine oils on the Internet at <http://bevo.mercedes-benz.com> by entering the designation, e.g. 229.5.

The table shows which engine oils have been approved for your vehicle.

**Petrol engines:** in certain countries, different engine oils can be used, provided that the maintenance intervals are reduced. For more information, please contact a qualified specialist workshop.

Model	MB Approval
All models	229.5

**i** If the engine oils listed in the table are not available, you may add the following engine oils until the next oil change:

- MB Approval 229.1 and 229.3 or ACEA A3
- This must only be added once and the amount must not be greater than 1.0 l.

### Capacities

The following values refer to an oil change including the oil filter.

Missing values were not available at the time of going to print.

Model	Replacement amount
All models	3.4 l

### Additives

**!** Do not use any additives with the engine oil. This could damage the engine.

## Engine oil viscosity

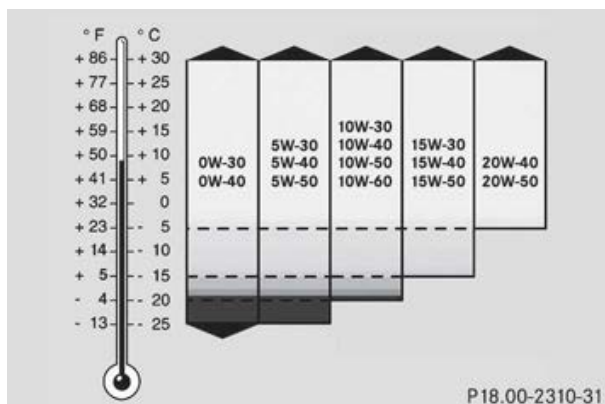

Viscosity describes the flow characteristics of a fluid. If an engine oil has a high viscosity rating, it flows slowly; the lower the viscosity, the faster it flows.

Engine oil selection is based on the respective outside temperatures and in accordance with the SAE classification (viscosity). The table shows you which SAE classifications are to be used. The low-temperature properties of engine oils can be significantly impaired during operation due to, for example, ageing or soot and fuel accretion. It is therefore strongly recommended to observe regular oil changes using an approved engine oil with the appropriate SAE classification.

### Brake fluid

When handling brake fluid, observe the important safety notes on service products (▷ page 268).

The brake fluid change intervals can be found in the Service Booklet.

Only use brake fluid approved by Mercedes-Benz according to MB Approval 331.0.

Information about approved brake fluid can be obtained at any qualified specialist workshop or on the Internet at: <http://bevo.mercedes-benz.com>.

**i** Have the brake fluid regularly replaced at a qualified specialist workshop and

the replacement confirmed in the Service Booklet.

### Coolant

#### General notes

**!** Only add coolant that has been premixed with the desired antifreeze protection. You could otherwise damage the engine. Further information on coolants can be found in the Mercedes-Benz Specifications for Service Products, MB Specifications for Service Products 310.1, e.g. on the Internet at <http://bevo.mercedes-benz.com>. Or contact a qualified specialist workshop.

**!** Always use a suitable coolant mixture, even in countries where high temperatures prevail.

Otherwise, the engine cooling system is not sufficiently protected from corrosion and overheating.

**i** Have the coolant regularly replaced at a qualified specialist workshop and the replacement confirmed in the Service Booklet.

Comply with the important safety precautions for service products when handling coolant (▷ page 268).

The coolant is a mixture of water and antifreeze/corrosion inhibitor. It performs the following tasks:

- corrosion protection
- antifreeze protection
- raising the boiling point

If antifreeze/corrosion inhibitor is present in the correct concentration, the boiling point of the coolant during operation will be approximately 130 °C.

The antifreeze/corrosion inhibitor concentration in the engine cooling system should:

- be at least 50%. This will protect the engine cooling system against freezing down to approximately -37 °C.
- not exceed 55% (antifreeze protection down to -45 °C). Heat will otherwise not be dissipated as effectively.

smart recommends an antifreeze/corrosion inhibitor concentrate in accordance with MB Specifications for Service Products 310.1.

- i** When the vehicle is first delivered, it is filled with a coolant mixture that ensures adequate antifreeze and corrosion protection.
- i** The coolant is checked at every maintenance interval at a qualified specialist workshop.

### Windscreen washer system

#### General notes

- !** Do not use distilled or de-ionised water in the washer fluid reservoir. Otherwise, the level sensor may be damaged.
- !** Only the washer fluids SummerFit and WinterFit can be mixed. Otherwise, the spraying nozzles could become blocked.

When handling washer fluid, observe the important safety notes on service products (▷ page 268).

At temperatures above freezing:

- ▶ Fill the washer fluid reservoir with a mixture of water and washer fluid, e.g. MB SummerFit.

Mix 1 part MB SummerFit to 100 parts water.

At temperatures below freezing:

- ▶ Fill the washer fluid reservoir with a mixture of water and washer fluid, e.g. MB WinterFit.

The correct mixing ratio can be taken from the information on the antifreeze protection container.

- i** Add washer fluid concentrate, e.g. MB SummerFit or MB WinterFit, to the washer fluid all year round.

### Vehicle data

#### General notes

Please note that for the specified vehicle data:

- the heights specified may vary as a result of:
  - tyres
  - load
  - condition of the suspension
  - optional equipment
- optional equipment reduces the maximum payload.
- vehicle-specific weight information can be found on the vehicle identification plate (▷ page 267).
- only for certain countries: you can find vehicle-specific vehicle data in the COC documents (EU CERTIFICATE OF CONFORMITY). These documents are delivered with your vehicle.

You can find the correct values for your model with the help of the VIN on the vehicle identification plate (▷ page 267).

### Dimensions and weights



<b>Model</b>	<b>①</b> <b>Opening height</b>
--------------	-----------------------------------

<b>All models</b>	2012 mm
-------------------	---------

#### All models

<b>Vehicle length</b>	3495 mm
-----------------------	---------

<b>Vehicle width including exterior mirrors</b>	1875 mm
---	---------

<b>Vehicle width excluding exterior mirrors</b>	1665 mm
---	---------

<b>Vehicle height</b>	1554 mm
-----------------------	---------

<b>Wheelbase</b>	2494 mm
------------------	---------

<b>Maximum boot load</b>	75 kg
--------------------------	-------

>> Technical data.





## Publication details

### Internet

Further information about smart vehicles and about Daimler AG can be found on the following websites:

<http://www.smart.com>

<http://www.daimler.com>

### Editorial office

You are welcome to forward any queries or suggestions you may have regarding this Owner's Manual to the technical documentation team at the following address:

Daimler AG, HPC: CAC, Customer Service,  
70546 Stuttgart, Germany

©Daimler AG: not to be reprinted, translated or otherwise reproduced, in whole or in part, without written permission from Daimler AG.

### Vehicle manufacturer

Daimler AG  
Mercedesstraße 137  
70327 Stuttgart  
Germany

As at 29.10.2014

Order no. 6522 0127 02  
Part no. 453 584 99 02  
Edition NA2014-11c

