

SMART EQ FORFOUR OWNER'S MANUAL



Quick Links

[Cockpit](#)

[Charging the High-Voltage Battery](#)

Table of Contents

Table of Contents

Protecting the environment

smart genuine parts

Warranty for the smart Audio-System and smart Media-System

Vehicle equipment

Operating safety

QR codes for rescue card

Data stored in the vehicle

Copyright information

Cockpit

Multifunction steering wheel

Centre console with drawer

Overhead control panel

Door control panel

Displays shown in the instrument cluster and the display

Occupant safety

Travelling safely with children in the vehicle

Pets in the vehicle

Driving safely

Understanding functions of the key

Opening the door

Correct driver's seat position

Adjusting the seats

Adjusting the steering wheel

Adjusting the mirrors

Adjusting head restraints in the rear compartment

Using the armrest

Starting the engine

Pulling away

Automatic transmission

Using the turn signals

Acoustic presence indicator

Radar-based recuperation

Driving economically

Braking correctly

Driving on wet roads

Winter driving

Lane Keeping Assist

Cruise control and limiter

Charging the high-voltage battery

Switching on the lighting

Adjusting the lighting

Using the interior lighting

Using the windscreen wipers

Folding the sun visor to the side

Locking and unlocking the doors from the inside

Understanding the reversing feature

Opening and closing the windows

Opening and closing the folding top

Operating the climate control system

Activating/deactivating the seat heating and steering wheel heating

Using the accessories

Parking

Using the parking aid

Using the reversing camera

Locking the vehicle

Priming and deactivating the anti- theft alarm system

Overview of the on-board computer

Calling up displays

Setting values

Operating and setting the smart Audio-System

Listening to the radio

Using a mobile phone

Operating external data storage media

Operating and setting up the smart Media-System

Listening to the radio

Displaying energy consumption

Using a mobile phone

Connecting and operating external data storage media

Viewing images

Video playback

Using TomTom Services

Using the navigation system

Online access to the vehicle

Using smart "ready to" services

Stowing small objects

Removing and fitting the rear shelf

Stowing luggage and large objects

Using lashing eyelets

Enlarging the load compartment

Removing/fitting the charging cable bag

Useful information

Removing/fitting the subwoofer

Opening and closing the service cover

Checking service products and topping up

Checking wheels and tyres

Changing a wheel

Using the tyre pressure monitor

Checking the tyre pressures

Using winter tyres

Using snow chains

Changing the window wiper blades

Cleaning the vehicle

Observing service due dates

Parking up the vehicle

Securing the vehicle in the event of an accident or a breakdown

Removing the first-aid kit

Removing the fire extinguisher

Removing the vehicle tool tray

Sealing tyres using the TIREFIT kit

Towing the vehicle

Manually releasing the selector lever lock

Replacing the bulbs

Changing fuses

Replacing the key battery

Opening a door with the emergency release

Locking the doors in an emergency

Unlocking the tailgate with the emergency release

Notes on display messages

Locking and unlocking

Vision, vehicle occupants, airbag

Engine, brakes, transmission

Charging process

Driving safety systems

Driver assistance systems

Battery, lights, heating

smart Audio-System and smart Media-System

Obtaining technical data

Reading vehicle data

Service products

Bulb types

Fuse allocation

Other ManualsLib Projects



>> Owner's Manual

smart EQ forfour

Symbols in the Owner's Manual

The following symbols are used in this Owner's Manual:

WARNING

Warning notes make you aware of dangers which could pose a threat to your health or life, or to the health and life of others.

Environmental note

Environmental notes provide you with information on environmentally aware actions or disposal.

 Notes on material damage alert you to dangers that could lead to damage to your vehicle.

 These symbols indicate useful instructions or further information that could be helpful to you.

▶ Instructions that must be followed.

▶ Several consecutive symbols indicate an instruction with several consecutive steps.

(▷ page) Further information on a topic

▷▷ A warning or an instruction that is continued on the next page.

Display text: Display text in the instrument cluster display, the smart Audio-System or the smart Media-System.

About this Owner's Manual

Before you first drive off, read this Owner's Manual carefully and familiarise yourself with your vehicle. For your own safety and a longer vehicle life, follow the instructions and warning notices in this manual. Disregarding them may lead to damage to the vehicle or personal injury.

This Owner's Manual provides information on the most important functions of your vehicle.

The equipment or model designation of your vehicle may vary according to:

- Model
- Order
- Country variant
- Availability

The illustrations in this manual show a left-hand-drive vehicle. On right-hand-drive vehicles, the layout of components and controls differs accordingly.

smart is constantly updating its vehicles to the state of the art.

smart therefore reserves the right to introduce changes in the following areas:

- Design
- Equipment
- Technical features

Therefore, the description may differ from your vehicle in some cases.

Integral parts of the vehicle include:

- Owner's Manual
- Service Booklet
- Equipment-dependent Supplements

These documents should be kept in the vehicle at all times. If you sell the vehicle, always pass all documents on to the new owner.

Your Owner's Manuals:



Digital on the Internet

The Owner's Manual on the Internet provides you with convenient access to all the information relevant to your vehicle and multimedia system. It also offers helpful animations, exciting background information and a wide variety of search options.



Digital as an app

Using the smart guides app, you can call up all of the information relevant to

your vehicle and multimedia system online on your phone or as a download regardless of the status of your network connection. Available for smartphones or tablets.

QR codes for the smart guides app.



Apple® iOS



Android™

Please note that the smart guides app may not currently be available in your country.

Index	5	Using the turn signals	69
Introduction	21	Acoustic presence indicator	69
Protecting the environment	21	Radar-based recuperation	69
smart genuine parts	21	Driving economically	70
Warranty for the smart Audio-Sys- tem and smart Media-System	22	Braking correctly	73
Vehicle equipment	22	Driving on wet roads	74
Operating safety	22	Winter driving	74
QR codes for rescue card	27	Lane Keeping Assist	74
Data stored in the vehicle	27	Cruise control and limiter	75
Copyright information	29	Charging the high-voltage battery	76
At a glance	30	Ensuring good visibility	86
Cockpit	30	Switching on the lighting	86
Multifunction steering wheel	31	Adjusting the lighting	87
Centre console with drawer	32	Using the interior lighting	88
Overhead control panel	33	Using the windscreen wipers	88
Door control panel	34	Folding the sun visor to the side	90
Displays shown in the instrument cluster and the display	35	Feeling comfortable in the vehicle interior	91
Safety	36	Locking and unlocking the doors from the inside	91
Occupant safety	36	Understanding the reversing fea- ture	92
Travelling safely with children in the vehicle	42	Opening and closing the windows	92
Pets in the vehicle	56	Opening and closing the folding top ...	93
Driving safely	56	Operating the climate control sys- tem	94
Entering and setting up	60	Activating/deactivating the seat heating and steering wheel heating ...	96
Understanding functions of the key ...	60	Using the accessories	97
Opening the door	60	Parking and getting out	102
Correct driver's seat position	60	Parking	102
Adjusting the seats	61	Using the parking aid	102
Adjusting the steering wheel	62	Using the reversing camera	103
Adjusting the mirrors	63	Locking the vehicle	105
Adjusting head restraints in the rear compartment	64	Priming and deactivating the anti- theft alarm system	105
Using the armrest	65	Operating the on-board computer	106
Driving	66	Overview of the on-board computer ..	106
Starting the engine	66	Calling up displays	107
Pulling away	66	Setting values	109
Automatic transmission	68		

Using the smart Audio-System	112	Using winter tyres	163
Operating and setting the smart Audio-System	112	Using snow chains	164
Listening to the radio	114	Changing the window wiper blades ..	164
Using a mobile phone	116	Cleaning the vehicle	165
Operating external data storage media	118	Observing service due dates	169
		Parking up the vehicle	169
Using the smart Media-System	120		
Operating and setting up the smart Media-System	120	Dealing with accidents and breakdowns	170
Listening to the radio	125	Securing the vehicle in the event of an accident or a breakdown	170
Displaying energy consumption	126	Removing the first-aid kit	173
Using a mobile phone	127	Removing the fire extinguisher	173
Connecting and operating external data storage media	131	Removing the vehicle tool tray	174
Viewing images	133	Sealing tyres using the TIREFIT kit ..	174
Video playback	134	Towing the vehicle	177
Using TomTom Services	134	Manually releasing the selector lever lock	178
Using the navigation system	136	Replacing the bulbs	179
		Changing fuses	181
Using online offerings	146	Replacing the key battery	183
Online access to the vehicle	146	Opening a door with the emergency release	183
Using smart "ready to" services	146	Locking the doors in an emergency ..	184
		Unlocking the tailgate with the emergency release	184
Loading and stowing	148		
Stowing small objects	148	Practical advice	186
Removing and fitting the rear shelf ..	149	Notes on display messages	186
Stowing luggage and large objects ...	149	Locking and unlocking	186
Using lashing eyelets	150	Vision, vehicle occupants, airbag	188
Enlarging the load compartment	151	Engine, brakes, transmission	190
Removing/fitting the charging cable bag	153	Charging process	192
		Driving safety systems	195
Maintenance and care	154	Driver assistance systems	200
Useful information	154	Battery, lights, heating	203
Removing/fitting the subwoofer	154	smart Audio-System and smart Media-System	205
Opening and closing the service cover	154		
Checking service products and topping up	156	Technical data	207
Checking wheels and tyres	157	Obtaining technical data	207
Changing a wheel	158	Reading vehicle data	207
Using the tyre pressure monitor	161	Service products	209
Checking the tyre pressures	162	Bulb types	209
		Fuse allocation	210

Radio type approvals for the tyre pressure monitors	212
Installing two-way radios and mobile phones	213

1, 2, 3 ...

12 V battery

Important safety notes 25

12 V socket

see Socket (12 V)

A**ABS (Anti-lock Braking System)**

Display message 195

Function/notes 56

Warning lamp (yellow) 195

Acceleration

see Kickdown

Acoustic presence indicator

Deactivating/activating 69

Function/notes 69

Active Brake Assist

Activating or deactivating 58

Display message 200

Forward collision warning
function 58

Function/notes 57

Important safety notes 57

Switching off/on (on-board
computer with colour display) 110Switching on/off (on-board
computer with monochrome
display) 109**Adaptive brake lights** 58**Adjusting the headlamp range** 87**Air conditioning**

General notes 94

Air distributionSetting (automatic climate con-
trol) 94**Air pressure**

see Tyre pressure

Air vents

Important safety notes 96

Setting 96

Air vents

see Air vents

Air-recirculation modeSwitching on/off (automatic
climate control) 95**Airbag**Enabling and disabling the
passenger airbag* 51

Installation locations 40

Limited protection 41

Overview 40

PASSENGER AIR BAG indicator
lamps 41**Airbags**Front airbag (driver, front
passenger) 40

Kneebag 40

Protection provided 40

Sidebag 40

Triggering 37

Windowbag 40

Alarm

Anti-theft alarm system 105

Switching off 105

Alerts

Setting (Audio-System) 115

Ambient lighting

Setting the brightness 111

Switching on/off 110

Android Auto™

Using 130

Animals

see Pets in the vehicle

Anti-entrapment feature

see Reversing feature

Anti-lock Braking System

see ABS (Anti-lock Braking System)

Anti-skid chains

see Snow chains

Anti-theft alarm system

Priming/deactivating 105

Switching off the alarm 105

Aquaplaning 74**Ashtray** 97**Audio-System**

Connecting a mobile phone 116

Connecting Bluetooth® audio
devices 119Connecting external audio
equipment (AUX) 119

Operating 112

Operating the radio 114

Operating via the mobile phone .. 113

- Overview 112
 - Setting interruption for news 115
 - Setting the time 114
 - Smartphone bracket 112
 - System settings 113
 - Troubleshooting 205
 - Using external devices 112
 - Volume/sound settings 114
 - Warranty 22
 - Authorised workshop**
 - see Qualified specialist workshop
 - Automatic climate control**
 - Activating/deactivating air-recirculation mode 95
 - Cooling with air dehumidification 95
 - Demisting the rear window 95
 - Demisting the windscreen 95
 - Increasing/decreasing the blower speed 94
 - Setting air distribution 94
 - Setting the temperature 94
 - Switching on/off 94
 - Windows misted up 95
 - Automatic headlamp mode** 86
 - Automatic transmission**
 - Display message 191
 - Engaging neutral 68
 - Engaging reverse gear 68
 - Engaging the park position 68
 - Important safety notes 68
 - Kickdown 68
 - Manually releasing the selector lever lock 178
 - Pulling away 66
 - Starting the engine 66
 - Transmission positions 68
 - AUX jack**
 - Audio-System 112
 - Media-System 120
- B**
- Battery**
 - Display message 203
 - Battery**
 - see High-voltage battery
 - Battery (key)**
 - Important safety notes 183
 - Replacing 183
 - Battery (vehicle)**
 - see High-voltage battery
 - Belt**
 - see Seat belt
 - Belt tensioner**
 - Activation 37
 - Belt warning** 39
 - Blower speed**
 - Increasing or decreasing (automatic climate control) 94
 - Bluetooth®**
 - Activating mobile phone (Audio-System) 116
 - Activating the mobile phone (Media-System) 127
 - Authorising function for mobile phone (Audio-System) 116
 - Connecting a device (Media-System) 132
 - Operating (Audio-System) 119
 - Switching on/off (Media-System) 127
 - Bonnet (front)**
 - see Service cover
 - Brake**
 - EBD 59
 - Brake Assist**
 - see Active Brake Assist
 - Brake fluid**
 - Display message 191
 - Brake force distribution**
 - see EBD (electronic brake force distribution)
 - Brake lamp**
 - Replacing bulbs 180
 - Brake lamps**
 - Adaptive 58
 - Display message 203
 - Brakes**
 - ABS 56
 - Driving tips 73
 - Important safety notes 73
 - Parking brake 67
 - Warning lamp 191

- Braking**
 - Braking on steep downhill gradients 73
 - Braking on wet road surfaces 73
 - Limited braking performance on salt-treated roads 73
 - Breakdown**
 - Towing away 177
 - see Flat tyre
- C**
- Car**
 - see Vehicle
 - Car key**
 - see Key
 - Car wash**
 - see Care
 - Car wash (care)** 165
 - Care**
 - Automatic car wash 165
 - Carpets 169
 - Cleaning the interior 168
 - Display 168
 - Exterior 165
 - Exterior lighting 167
 - High-pressure cleaner 166
 - High-voltage battery 79
 - Interior 168
 - Notes 165
 - Paint 167
 - Plastic trim 168
 - Reversing camera 166
 - Roof lining 167, 169
 - Seat belt 168
 - Seat cover 168
 - Selector lever 168
 - Sensors 166
 - Steering wheel 168
 - Trim pieces 169
 - Washing by hand 166
 - Wheels 166
 - Windows 167
 - Wiper blades 167
 - Cargo box**
 - Removing (rear seats) 153
 - Central locking**
 - Automatic locking 91
 - Locking/unlocking (key) 105
 - Centre console**
 - Overview 32
 - Changing the route**
 - Navigation 140
 - Charge cable**
 - Display message 192
 - Charge level display** 71
 - Charging**
 - see Charging the high-voltage battery
 - Charging cable**
 - Connection 85
 - Control panel 82
 - Disconnecting 85
 - Heating up 79
 - Storing 85
 - Version 1 (mode 2) 83
 - Version 2 (mode 2) 83
 - Charging cable bag**
 - Removing/fitting 153
 - Charging current**
 - Display messages 192
 - Child seat**
 - Approval categories 46
 - Basic instructions 42
 - Disabling or enabling the front passenger front airbag 51
 - Front passenger seat (notes) 55
 - ISOFIX/i-Size (fitting) 49
 - Notes on risks and dangers 43
 - Recommendations for child restraint systems 45
 - Seats suitable for belt-secured child restraint systems 53
 - Seats suitable for ISOFIX child restraint systems 48
 - Securing (notes) 46
 - Securing on the front passenger seat 55
 - Securing on the rear seat 54
 - Suitability of the seats for i-Size child restraint systems 49
 - Top Tether 51
 - Children**
 - Avoiding dangers in the vehicle 43
 - Basic instructions 42
 - Cigarette lighter** 97

- Cleaning**
see Care
- Climate control**
Automatic air conditioning 94
Setting the air vents 96
- Clock**
Setting the time (Media-System) 123
- Cockpit**
Overview 30
- Collision warning**
Warning lamp 200
- COMAND display**
Cleaning 168
- Connectivity manager** 135
- Constant headlamp mode**
see Daytime driving lights
- Consumption details**
Calling up (Media-System) 127
- Controlling speed**
see Cruise control
- Coolant**
Checking coolant level and topping up 156
Important safety notes 156
- Cooling**
see Climate control
- Controlling with air dehumidification**
Automatic climate control 95
- Copyright** 29
- Cornering light function** 87
- Cover (front)**
see Service cover
- Crosswind Assist** 58
- Cruise control**
Activating 76
Buttons 76
Calling up the speed last stored 76
Cancelling cruise control 76
Deactivating 76
Display message (colour display) 202
Display message (monochrome display) 202
Function/notes 75
General notes 75
Important safety notes 75
Increasing/decreasing the speed 76
Storing and maintaining current speed 76
- Cup holder**
Centre console 148
Important safety notes 148
Rear compartment 149
- Cup holder**
see Cup holder
- ## D
- DAB radio**
see Digital radio
- Dashboard**
see Cockpit
- Data**
see Technical data
- Data sharing**
Managing 136
- Data storage media**
see External data storage media
- Daytime driving lights** 86
- Dealership**
see Qualified specialist workshop
- Declarations of conformity** 23
- Diagnostics connection** 25
- Digital radio**
Audio-System 115
Displaying services (Media-System) 126
EPG (Electronic Programme Guide) (Media-System) 126
Frequency range (Audio-System) 115
Intellitext™ (Media-System) 126
Introducing (Audio-System) 115
Media-System 125
Setting interruption for news (Audio-System) 115
Slide show (Media-System) 126
- Digital speedometer**
Displaying 110
- Dipped-beam headlamps**
Driving abroad 88
Replacing bulbs 179
Switching on/off 86

- Display**
 Colour 106
 Monochrome 106
- Display message**
 Colour display 109
- Display messages**
 General information 186
- Disposal of old devices** 80
- Distance recorder**
 Monochrome display 107
- Distance recorder**
 see Trip meter
- Door**
 Automatic locking (switch) 91
 Central locking/unlocking (key) .. 105
 Control panel 34
 Display message 187
 Emergency locking 184
 Emergency unlocking 183
 Opening (from the inside) 91
 Unlocking (key) 60
- Double lock function** 91
- Driver's door**
 see Door
- Driver's seat**
 see Seat
- Driving abroad**
 Symmetrical dipped beam 88
- Driving noise**
 see Acoustic presence indicator
- Driving safety system**
 Active Brake Assist 57
 Crosswind Assist 58
 Driving safety system limitations 56
 EBD (electronic brake force distribution) 59
- Driving safety systems**
 ABS (Anti-lock Braking System) 56
 Adaptive brake lights 58
 ESP® (Electronic Stability Program) 58
 ETS (Electronic Traction System) 58
- Driving systems**
 Cruise control 75
 Lane Keeping Assist 74
 Speed limiter 75
- Driving tips**
 Aquaplaning 74
 Brakes 73
 Downhill gradient 73
 Driving in winter 74
 Driving on flooded roads 74
 Driving on wet roads 74
 Icy road surfaces 74
 Limited braking efficiency on
 salted roads 73
 Pulling away 66
 Symmetrical dipped beam 88
 see Economical driving
- Dynamic handling control system**
 see ESP® (Electronic Stability Program)

E

EBD (electronic brake force distribution)

- Function/notes 59
 Indicator lamp 195

ECO mode

- Switching on/off 70

eco score

- Calling up 72
 Comparing the trip 72
 Display (colour display) 72
 Display (monochrome display) 72
 Evaluating the current trip 72
 Function/notes 71
 Resetting data 73
 Saving the trip 72

Economical driving

- eco score display 71
 General information 70

Electrical fuses

see Fuses

Electromagnetic compatibility

- Declaration of conformity 23

Electronic Brake-force Distribution

see EBD (electronic brake force distribution)

Electronic Stability Program

see ESP® (Electronic Stability Program)

- Electronic Traction System**
see ETS (Electronic Traction System)
- Emergency assistance system**
Automatic emergency call 171
Button in the overhead control panel 170
Manual emergency call 171
Overview 170
Requirements 170
Transmitted data 170
- Emergency release**
Driver's door 183
- Emergency unlocking**
Tailgate 184
Vehicle 183
- Energy**
Displaying the current consumption (colour display) 108
- Energy consumption**
High-voltage battery 79
- Energy flow display**
Calling up (Media-System) 126
Colour display 108
- Engine**
Starting problems 190
Starting the engine with the key .. 66
- Engine electronics**
Notes 22
- Entering a destination**
Navigation 137
- Environmental protection**
High-voltage battery 21
Returning an end-of-life vehicle 21
- EPG (Electronic Program Guide)**
Displaying (Audio-System) 116
- EPG (Electronic Programme Guide)**
Displaying (Media-System) 126
- ESP® (Electronic Stability Program)**
Crosswind Assist 58
Display message 196
General notes 58
Important safety guidelines 58
Warning and indicator lamps 196
- ETS (Electronic Traction System) 58**
- Exterior lighting**
Cleaning 167
see Lights
- Exterior mirrors**
Adjusting 64
Out of position (troubleshooting) 188
- External audio equipment (AUX)**
Connecting (Audio-System) 119
- External data carriers**
Connection (Media-System) 132
Operation (Media-System) 132
- External data storage media**
Connecting (Audio-System) 112
Operating (Audio-System) 118

F

- Factory settings**
Resetting (Media-System) 123
- Favourites**
Creating (Media-System) 124
Managing (Media-System) 124
- Fire extinguisher 173**
- First-aid kit 173**
- Fitting a wheel**
Fitting a wheel 160
Preparing the vehicle 159
Raising the vehicle 159
Removing a wheel 159
Securing the vehicle against rolling away 172
- Fitting/removing**
front wheel arch cover 180
- Flat tyre**
Preparing the vehicle 170
TIREFIT kit 174
- Floormat 98**
- Foglamps**
Switching on/off 87
- Folding top**
Important safety notes 93
Operating 93
Problem (malfunction) 187
- Fording**
On flooded roads 74
- Forward collision warning function**
Function/notes 58
- Frequencies**
Mobile phone 213
Two-way radio 213

Front airbag	40
Front cover	
see Service cover	
Front wheel arch	
Fitting/removing the cover	180
Front-passenger front airbag deactivation system	
PASSENGER AIR BAG indicator lamps	41
Status indicator	41
Front-passenger seat	
see Seat	
Frontal area cover	
see Service cover	
Fuses	
Allocation chart	210
Before changing	182
Dashboard fuse box	182
Important safety notes	181
Opening the fuse box	182

G

Glove compartment	149
--------------------------------	-----

H

Hand brake	
see Parking brake	
Hands-free system	
see Mobile phone	
Hazard warning lamps	
Switching on/off	170
Head restraints	
Adjusting (rear)	64
Headlamp flasher	87
Headlamps	
see Automatic headlamp mode	
Heating	
see Climate control	
High-voltage battery	
Battery care	79
Charge level	71
Charge level display	71
Charging (charging station)	81
Charging (mains socket)	85
Charging (wallbox)	81
Charging cable heating up	79
Discharged battery	78

Display message	203
Energy consumption	79
Important safety notes	76
Indicator lamp (vehicle socket)	80
Method of operation	78
Outside temperatures	79
Problems during charging	192
Protective equipment	79
Range	79
READY indicator	203
Terms of use	79
Vehicle socket	80
Warning and indicator lamps	203

High-voltage electrical system

Automatic switch-off	26
Danger of electric shock	26
Operating safety	26
Vehicle fire	26

Hinged windows

Opening/closing	93
-----------------------	----

Home address

Entering and saving	138
---------------------------	-----

Home address (navigation)

see Home address	
------------------	--

I

i-Size child seat securing system

Fitting	49
Suitable seats for securing	49

i-Traffic

Traffic announcements	126
-----------------------------	-----

Ice warning

Warning lamp (colour display)	202
Warning lamp (monochrome display)	202

Ignition lock

see Key positions	
-------------------	--

Image

Playback (Media-System)	133
-------------------------------	-----

Immobiliser	105
--------------------------	-----

Indicator and warning lamp

Restraint system	189
------------------------	-----

Indicator and warning lamps

Battery	203
---------------	-----

Indicator lamps

see Warning and indicator lamps	
---------------------------------	--

- Instrument cluster**
 Overview 35
 Warning and indicator lamps 35
- Instrument cluster lighting**
 Setting 110
- Instrument lighting**
 see Instrument cluster lighting
- Intellitext™**
 Setting (Media-System) 126
 Switching on (Audio-System) 116
- Interior lighting** 88
 Adjusting the ambient lighting
 (colour display) 88
 Changing bulbs 181
 Setting the ambient lighting 110
 Switching on/off 88
- Intermittent wipe** 89
- ISOFIX child seat securing system**
 Fitting 49
 Suitable seats for securing 48
- J**
- Jack**
 Using 159
- K**
- Key**
 Changing the battery 183
 Loss 186
 Position in the ignition lock 66
 Problem (malfunction) 186
 Starting the engine 66
- Key positions (ignition lock)** 66
- Keyboard**
 Adjusting (Media-System) 122
- Kickdown** 68
- Kneebag** 40
- L**
- Lamps**
 see Warning and indicator lamps
- Lane Keeping Assist**
 Activating/deactivating 75
 Function/information 74
 Warning lamp (colour display) 202
- Warning lamp (monochrome display) 202
- Lane recognition system (automatic)**
 see Lane Keeping Assist
- Language**
 Selecting (Media-System) 122
- Language (on-board computer)** 111
- Lashing eyelets** 150
- Licence plate lighting**
 Changing bulbs 181
- Light**
 see Replacing bulbs
- Lighting**
 see Lights
- Lights**
 Automatic headlamp mode 86
 Cornering light function 87
 Dipped-beam headlamps 86
 Display message 204
 Driving abroad 88
 Foglamps 87
 Hazard warning lamps 170
 Headlamp flasher 87
 Headlamp range 87
 Light switch 86
 Main-beam headlamps 86
 Rear foglamp 87
 Setting the ambient lighting 110
 Side lamps 87
 Turn signals 69
 see Interior lighting
- Limiter**
 Calling up the stored limit
 speed 76
 Cancelling 76
 Deactivating 76
 Display message (colour display) 202
 Exceeding the stored limit
 speed 75
 General notes 75
 Increasing or reducing the
 stored limit speed 76
- Limiting the speed**
 see Speed limiter
- Loading guidelines** 149

- Locking**
 - see Central locking
 - Locking (doors)**
 - Automatic 91
 - Emergency locking 184
 - From inside (central locking button) 91
 - Loudspeaker**
 - see Subwoofer
 - Luggage compartment enlargement ..** 151
- M**
- M+S tyres (winter tyres)** 163
 - Main-beam headlamps**
 - Replacing bulbs 179
 - Switching on/off 86
 - Making a call**
 - Media-System 128
 - Malfunction message**
 - see Display message
 - Manually releasing the selector lever lock (automatic transmission) ...** 178
 - Media-System**
 - Adjusting the on-screen keyboard 122
 - Buttons on the multifunction steering wheel 120
 - Calling up Applications manager 135
 - Calling up menus 122
 - Connectivity manager 135
 - Consumption details 127
 - Controls 120
 - Creating favourites 124
 - Data connectivity 134
 - Display settings 122
 - Downloading updates and POIs ... 135
 - eco score 72
 - Enabling data sharing 136
 - Energy flow display 126
 - Home screen 121
 - Image playback 133
 - Navigation menu 136
 - Navigation system 136
 - Operating the radio 125
 - Overview 120
 - Problem solving 205
 - Reversing camera 103
 - Selecting the home screen display 123
 - Selecting the language 122
 - Setting the time 123
 - Setting warning tones 124
 - Status and information 123
 - Switching on/off 121
 - System menu 122
 - System settings 122
 - Video playback 134
 - Volume/tone settings 123
 - Warranty 22
 - Message memory (colour display)** 109
 - MirrorLink™**
 - Using 129
 - Mirrors**
 - see Exterior mirrors
 - see Rear-view mirror
 - Mobile phone**
 - Connecting (Audio-System) 116
 - Connecting (Media-System) 127
 - Downloading data automatically (Media-System) 128
 - Frequencies 213
 - Installation 213
 - Loading and updating the telephone book (Audio-System) 116
 - Making a call (Media-System) 128
 - Setting the sound (Audio-System) 117
 - Transmission output (maximum) 213
 - Using Android Auto™ 130
 - Using MirrorLink™ 129
 - Using voice control (Audio-System) 118
 - Using voice control (Media-System) 131
 - Model series**
 - see Vehicle identification plate
 - Multi-functional seat**
 - see Seat
 - Multifunction steering wheel**
 - Overview 31

N

Navigation

Alternative route	140
Changing the route	140
Current location	143
Destination memory	138
Displaying the reachability map	143
Entering a charging station as a destination	138
Entering a destination	137
Entering a destination by address	137
Entering a destination using geo-coordinates	137
Entering a destination using the map	137
Entering a POI	138
Entering/saving your home address	138
Reading map data	136
Route details	140
Selecting a destination from the list of last destinations	137
Setting route planning	141
Setting the voice	144
Starting	136
Starting route calculation	139
Switching announcements on/off	141
System settings	144
TomTom Services	134
Traffic information	142
Troubleshooting	205
Way points	140

O

Occupant safety

Airbags	40
Belt warning	39
Children in the vehicle	42
PASSENGER AIRBAG indicator lamp	41
Pets in the vehicle	56
Restraint system	36
Restraint system warning lamp	36
Seat belts	38

On-board computer

Calling up displays (colour display)	107
Calling up displays (monochrome display)	107
Important safety notes	106
Operation	106
Overview	106
Selecting the language	111
Setting and resetting values (colour display)	109
Setting and resetting values (monochrome display)	109

On-board diagnostics interface

see Diagnostics connection

On-screen keyboard

Adjusting (Media-System)	122
--------------------------------	-----

Online access 146**Operating instructions**

Vehicle equipment	22
-------------------------	----

Operating safety

Declaration of conformity	23
High-voltage electrical system	26

Operating system

see On-board computer

Original parts 21**Outside temperature display**

Colour display	106
Monochrome display	106
Setting the units	110

Outside temperatures

High-voltage battery	79
----------------------------	----

Overhead control panel 33**Overvoltage protection**

High-voltage battery	79
----------------------------	----

P

Paint code 207**Paintwork (cleaning instructions)** 167**Panorama roof**

Cleaning	167
----------------	-----

Park brake

see Parking brake

Parking 102

Engaging park position	68
Important safety notes	102
Parking aid	102

- Parking brake 67
- Reversing camera 103
- Parking brake**
- Display message 191
- General information 67
- Warning lamp 191
- PASSENGER AIR BAG**
- Disabling/activating 51
- Indicator lamps 41
- Passenger airbag**
- Enabling and disabling* 51
- Problem (malfunction)* 189
- Passenger seat**
- Folding down 151
- Pets in the vehicle** 56
- Power display** 71
- Power windows**
- see Side windows
- Pre-entry climate control and charging**
- Colour display 109
- Pre-entry climate control at departure time**
- Smart-Charging 95
- Pre-entry climate control at time of departure**
- Setting departure time 95
- Protection against theft**
- Anti-theft alarm system 105
- Protection of the environment**
- General notes 21
- Pulling away**
- General notes 66
- Hill start assist 68
- Q**
- QR code**
- Rescue card 27
- Qualified specialist workshop** 25
- R**
- Radar-based recuperation**
- Function/notes 69
- Switching off/on (on-board computer with colour display) 110
- Radio**
- Display mode 125
- Displaying programme information (EPG) (Audio-System) 116
- i-Traffic (Traffic announcements) 126
- Operating (Audio-System) 114
- Operation (Media-System) 125
- Radio text**
- Displaying (Audio-System) 115
- Displaying (Media-System) 126
- Radio type approvals**
- Tyre pressure monitors 212
- Radio-based vehicle components**
- Declaration of conformity 23
- Rain sensor** 89
- Rain/light sensor (display message)** .. 203
- Range**
- High-voltage battery 79
- RBS**
- see Radar-based recuperation
- Reading lamp** 88
- Readyspace seats** 152
- Rear bench seat**
- Folding the backrest forwards/back 151
- Rear foglamp**
- Replacing bulbs 180
- Switching on/off 87
- Rear lamp**
- Replacing bulbs 180
- Rear parking aid**
- Activating/deactivating 102
- Function/notes 102
- Rear seat**
- Adjusting the angle of the backrests 152
- Rear seat heating 96
- Rear seat**
- see Rear bench seat
- Rear seats**
- readyspace seats 152
- Removing the cargo box 153
- Rotating the seat cushions 152
- Rear shelf** 149
- Rear window heating**
- Demisting the rear window (automatic climate control) 95

- Rear window wiper**
 Automatic rear window wiper
 when in reverse gear 89
 Replacing the wiper blade 165
 Switching on/off 89
- Rear-compartment seat belt status indicator** 40
- Rear-view mirror** 63
 Anti-dazzle mode (automatic) 63
 Dipping (manual) 63
- Recharging cable**
 Indicator lamp 82
- Recuperation (radar based)**
 Function/notes 69
- Recuperation (radar-based)**
 Switching on and off (colour display) 110
- Recycling**
 see Protection of the environment
- Reflective safety jacket** 173
- Remote configuration**
 smart control 146
- Remote query functions**
 smart control 146
- Replacing bulbs**
 Brake lamp 180
 Dipped-beam headlamps 179
 Fitting/removing the cover (front wheel arch) 180
 Important safety notes 179
 LED 180
 Licence plate lighting 181
 Main-beam headlamps 179
 Overview of bulb types 209
 Rear foglamp 180
 Rear lamp 180
 Reversing lamp 180
 Turn signal lamp (rear) 180
 see Changing bulbs
- Replacing lamps**
 see Changing bulbs
- Replacing the bulb**
 Turn signal lamp (front) 180
- Replacing the bulbs**
 Interior lighting 181
- Rescue card** 27
- Restraint system**
 Basic instructions 42
- Display message 189
 Function during an accident 37
 Limited protection 36
 Malfunction 36
 Operational readiness 36
 Protection provided 36
 System self-test 36
 Warning lamp 189
 Warning lamp (function) 36
- Reverse gear**
 Engaging (automatic transmission) 68
- Reversing camera**
 Cleaning instructions 166
 Function/notes 103
 Guide lines in the display 104
 Settings 104
 Switching on/off 104
- Reversing feature**
 Side windows 92
- Reversing lamp**
 Replacing bulbs 180
- Roof lining and carpets (cleaning instructions)** 169

S

Safety

- Children in the vehicle 42
 see Occupant safety
 see Operating safety

Safety system

- see Driving safety system

SD card

- Connecting (Media-System) 132
 Reading map data 136
 SD card slot 120

Seat

- Adjusting rear head restraint 64
 Correct driver's seat position 60
 Folding passenger seat down 151
 Folding the backrest (rear compartment) forwards/back 151

Seat belt

- Limited protection 38
 Protection provided 38

Seat belts

- Adjusting the height 39

- Cleaning 168
- Fastening 39
- Rear seat belt status indicator 40
- Releasing 39
- Warning lamp 188
- Warning lamp (function) 39
- Seat cushions**
 - Rotating (rear seats) 152
- Seat heating** 96
- Seats**
 - Adjusting (manually) 61
 - Cleaning the cover 168
 - Important safety notes 61
 - Switching seat heating on/off 96
- Selector lever**
 - Cleaning 168
- Selector lever**
 - see Automatic transmission
- Sensors (cleaning instructions)** 166
- Service Centre**
 - see Qualified specialist workshop
- Service cover** 154
- Service display**
 - Calling up (colour display) 109
 - Calling up (monochrome display) 107
- Service due date**
 - Display message 192
- Service products**
 - Brake fluid 209
 - Coolant (engine) 156
 - Important safety notes 156
 - Washer fluid 209
- Services menu settings**
 - TomTom Services 134
- Setting the charge current**
 - Charging cable version 2 84
- Side lamps**
 - Switching on/off 87
- Side windows**
 - Important safety notes 92
 - Opening/closing 93
 - Opening/closing the hinged window 93
 - Problem (malfunction) 187
 - Resetting 187
 - Reversing feature 92
- Sidebag** 40
- smart Centre**
 - see Qualified specialist workshop
- smart control**
 - Internet 146
- smart Services**
 - Registering 146
 - Using 146
- Smart-Charging**
 - Function/notes 95
- Smartphone**
 - Fitting the bracket 113
 - Inserting/removing 113
 - Operating the Audio-System via the mobile phone 113
- Smartphone Screen**
 - Setting (Media -System) 129
- Snow chains** 164
- Socket (12 V)**
 - Centre console 98
- Socket (high-voltage battery)**
 - see Vehicle socket
- Sound**
 - Setting (Audio-System) 114
 - Setting (Media-System) 123
- Sound generator**
 - see Acoustic presence indicator
- Speakers**
 - see Subwoofer
- Special destination**
 - Entry 138
- Specialist workshop** 25
- Speed limiter**
 - Activating 76
 - Functions and conditions for activation 75
 - Setting limit speed 76
- Speedometer**
 - Digital 106
 - Displaying (digital speedometer) 110
 - General notes (digital speedometer) 109
 - see Instrument cluster
- Starting (engine)** 66
- Starting the engine**
 - see Starting (engine)

- Station**
 Selecting a stored station
 (Audio-System) 115
 Setting (Media-System) 125
- Station list**
 Setting a station from the station list (Audio-System) 115
 Updating (Media-System) 126
- Station search**
 Audio-System 115
- Stations**
 Setting (Audio-System) 114
 Storing (Audio-System) 115
- Steering**
 Display message (colour display) 200
 Warning lamps 200
- Steering wheel**
 Adjusting (manually) 62
 Button overview 31
 Cleaning 168
 Important safety notes 62
- Steering wheel heating**
 Switching on/off 96
- Stowage compartments**
 Centre console 148
 Cup holder 148
 Door 148
 Glove compartment 148
 Important safety information 148
 Rear 149
- Subwoofer**
 Fitting/removing 154
- Sun visor** 90
- T**
- Tablet bracket**
 Affixing protective film 99
 Dismantling 101
 Important safety notes 98
 Mounting 99
 Using 98
- Tailgate**
 Emergency unlocking 184
 Opening dimensions 207
 Opening/closing 150
 Warning lamp 187
- Technical data**
 Information 207
 Vehicle data 207
- Telephone book**
 Loading (Audio-System) 116
- Telephone operation**
 Audio-System 117
- Temperature**
 Setting (automatic climate control) 94
- Time**
 Setting (Audio-System) 114
 Setting (colour display) 110
 Setting (monochrome display) 109
 Setting the time format (colour display) 110
- TIREFIT kit** 174
- TomTom Services**
 Activating 135
 Introduction 134
 My Services menu 135
 Starting 135
 Subscription status 135
 Traffic information menu 143
- Tool**
 see Vehicle tool kit
- Top Tether** 51
- Total distance recorder**
 Colour display 108
 Monochrome display 106
 Setting the display unit 110
- Touchscreen**
 Confirming settings with Done 122
 Operating the touchscreen 121
- Towing**
 Important safety notes 177
- Towing away**
 Fitting the towing eye 178
 Removing the towing eye 178
 With both axles on the ground 178
- Traction system**
 see ETS (Electronic Traction System)
- Traffic reports**
 Switching on/off 115
- Transmission**
 see Automatic transmission
- Transporting the vehicle** 178

- Trip computer**
 Displaying 108
- Trip meter**
 Colour display 108
 Displaying (colour display) 108
 Displaying (monochrome display) 107
- Trip meter**
 see Trip meter
- Turn signal lamp (front)**
 Replacing the bulb 180
- Turn signal lamp (rear)**
 Replacing bulbs 180
- Turn signals**
 Replacing the bulb 180
 Switching on/off 69
- Turn signals**
 see Turn signals
- Two-way radio**
 Frequencies 213
 Installation 213
 Transmission output (maximum) 213
- Type identification plate**
 see Vehicle identification plate
- Tyre pressure**
 Checking/correcting 163
 Display message 197
 Important safety notes 162
 Not reached (TIREFIT) 176
 Reached (TIREFIT) 176
 Recommended 162
- Tyre pressure monitor**
 Function/notes 161
 Radio type approval for the tyre pressure monitor 212
 Restarting 161
 Starting 110
 Warning lamp 197
- Tyres**
 Changing a wheel 158
 Checking 157
 Direction of rotation 160
 Important safety notes 157
 M+S tyres (winter tyres) 163
 Rules for new tyres 158
 Service life 158
 Snow chains 164
- Storing 161
 Tyre tread 157
 see Flat tyre

U

Unit of measurement for distance

- Setting 110

Units

- Setting (on-board computer) 110

Unlocking

- From inside the vehicle (central unlocking button) 91
 With emergency key element 183

USB device

- Connecting (Audio-System) 118
 Connection (Media-System) 132
 Operating (Audio-System) 118

USB port

- Audio-System 112
 Media-System 120

V

Values

- Setting (colour display) 109
 Setting (monochrome display) 109

Vehicle

- Correct use 27
 Data acquisition 27
 Electronics 22
 Equipment 22
 Implied warranty 27
 Locking (in an emergency) 184
 Locking (key) 105
 Operating safety 22
 Parking 102
 Parking up 169
 Raising 159
 Registration 26
 Remote configuration 146
 Remote query functions 146
 Securing from rolling away 172
 Towing away 177
 Transporting 178
 Unlocking (in an emergency) 183
 Unlocking (key) 60
 Vehicle data 207
- Vehicle data** 207

Vehicle dimensions	207
Vehicle emergency locking	184
Vehicle identification number see VIN	
Vehicle identification plate	207
Vehicle key see Key	
Vehicle socket High-voltage battery	80
Indicator lamp	80
Problems during the charging process	192
Vehicle tool kit	174
Ventilation see Air conditioning	
Video Playback (Media-System)	134
VIN	207
Voice control system Entering a destination in the navigation system	137
Problems with the voice control system	206
Starting an application	120
Voltage range High-voltage battery	78
Volume Adjusting automatically	114
Setting (Audio-System)	114
Setting (Media-System)	123

W

Warning and indicator lamps

ABS	195
Active Brake Assist	200
Brakes	191
Collision warning (red)	200
EBD	195
ESP® (yellow)	196
High-voltage battery	203
Lane Keeping Assist	201
Overview	35
Parking brake	191
PASSENGER AIR BAG	41
PASSENGER AIRBAG OFF	189
Seat belt	188
Steering	200

Tyre pressure monitor	197
Warning triangle	172
Wheel bolt tightening torque	160
Wheels Changing a wheel	158
Checking	157
Cleaning	166
Fitting a new wheel	160
Important safety notes	157
Removing a wheel	159
Snow chains	164
Storing	161
Tightening torque	160
Windowbag	40
Windows Cleaning	167
see Side windows	
Windscreen Demisting (automatic climate control)	95
Windscreen washer fluid see Windscreen washer system	
Windscreen washer system Important safety notes	157
Topping up	157
Windscreen wipers Intermittent wipe	89
Problem (malfunction)	188
Rain sensor	89
Rear window wiper	89
Replacing the wiper blades	164
Switching on/off	88
Wiping with washer fluid	89
Wing see Front wheel arch	
Winter driving General notes	74
Winter operation Slippery road surfaces	74
Snow chains	164
Winter tyres M+S tyres	163
Wiper blades Cleaning	167
Replacing (on the rear window) ...	165
Replacing (windscreen)	164
Workshop see Qualified specialist workshop	

Protecting the environment

General notes

🔍 Environmental note

Daimler's declared policy is one of comprehensive environmental protection.

Our objectives are to use the natural resources which form the basis of our existence on this planet sparingly and in a manner which takes the requirements of both nature and humanity into consideration.

You too can help to protect the environment by operating your vehicle in an environmentally-responsible manner.

Energy consumption and the rate of engine, transmission, brake and tyre wear depend on the following factors:

- operating conditions of your vehicle
- your personal driving style

You can influence both factors. Therefore, please bear the following in mind:

Operating conditions:

- observe the correct tyre pressure.
- do not carry any unnecessary weight in the vehicle
- remove the roof rack once you no longer need it.
- a regularly serviced vehicle will contribute to environmental protection. You should therefore adhere to the service intervals.
- all maintenance work should be carried out at a qualified specialist workshop.

Personal driving style:

- drive carefully and maintain a safe distance from the vehicle in front.
- avoid frequent, sudden acceleration and braking.
- monitor the vehicle's energy consumption.

High-voltage battery

🔍 Environmental note

Have a defective high-voltage battery disposed of in an environmentally-responsible manner. Contact a specialist workshop, which is qualified for smart EQ fortwo, smart EQ fortwo cabrio or smart EQ forfour, and has the necessary special skills and tools to carry out the work required. smart recommends a smart centre for this.

Returning an end-of-life vehicle

EU countries only:

smart will take back your end-of-life vehicle for environment-friendly disposal in accordance with the European Union (EU) End-Of-Life Vehicles Directive.

This makes an important contribution to closing the recycling circle and conserving resources. A network of vehicle take-back points and dismantlers has been established for you to return your vehicle. Returning vehicles to these facilities is free of charge.

For further information about the recycling and disposal of end-of-life vehicles, and the take-back conditions, please visit the national smart website for your country.

smart genuine parts

🔍 Environmental note

Daimler AG also supplies reconditioned assemblies and parts which are of the same quality as new parts. For these, the same warranty applies as for new parts.

⚠️ Airbags and seat belt tensioners, as well as control units and sensors for these restraint systems, may be installed in the following areas of your vehicle:

- doors
- door pillars
- door sills
- seats
- dashboard

- instrument cluster
- centre console

Do not install accessories such as audio systems in these areas. Do not carry out repairs or welding. You could impair the operating efficiency of the restraint systems.

Have accessories retrofitted at a qualified specialist workshop.

Only smart genuine parts or parts of the same quality may be used. Additionally, only tyres, wheels and accessories approved for the specific type of vehicle may be used.

Always specify the vehicle identification number (VIN) when ordering smart genuine parts.

Using parts, tyres, wheels or safety-relevant equipment not approved by smart could endanger the operating safety of the vehicle. Safety-relevant systems, e.g. the brake system, could malfunction.

smart tests genuine parts and conversion parts and accessories that have been specifically approved for your vehicle for their reliability, safety and suitability. Despite ongoing market research, smart is unable to assess other parts. smart therefore accepts no responsibility for the use of such parts in smart vehicles, even if they have been officially approved or independently approved by a testing centre.

In Germany, certain parts are only officially approved for installation or modification if they comply with legal requirements. This also applies to some other countries. All genuine smart parts meet the approval requirements. The use of non-approved parts may invalidate the vehicle's general operating permit.

The following situations will invalidate the operating permit:

- The vehicle type changes from that stated in the vehicle's operating permit, due to modifications.
- Other road users are likely to be endangered.
- Emissions or noise characteristics deteriorate.

Warranty for the smart Audio-System and smart Media-System

The smart sales organisation provides a warranty for a period of 24 months without a kilometre limit for the smart Audio-System and the smart Media-System.

The warranty issuer is the respective sales organisation in the country in which the accessory or replacement part was purchased (see list in the service booklet).

Vehicle equipment

This Owner's Manual describes all models and all standard and optional equipment available for the vehicle at the time of publication of this Owner's Manual. Country-specific differences are possible. Please note that the vehicle equipment may differ from certain descriptions and illustrations provided in this manual. This is also the case for systems and functions relevant to safety.

The vehicle's original purchase contract documentation contains a list of all the systems in your vehicle. Please contact any smart centre to help clarify any questions related to the vehicle equipment and operation.

Operating safety

Important safety notes

WARNING

If you do not have the prescribed service/maintenance work or necessary repairs carried out, this could result in malfunctions or system failures. There is a risk of an accident.

Always have the prescribed service/maintenance work as well as necessary repairs carried out at a qualified specialist workshop.

WARNING

If you operate information and communication equipment integrated in the vehicle

when driving, you could be distracted from the traffic situation. This could also cause you to lose control of the vehicle. There is a risk of an accident.

Only operate this equipment when the traffic situation permits. If you cannot be sure of this, stop the vehicle paying attention to road and traffic conditions and operate the equipment with the vehicle stationary.

WARNING

Modifications to electronic components, their software as well as wiring could affect their function and/or the operation of other networked components. This could in particular also be the case for systems relevant to safety. They might not function properly anymore and/or jeopardise the operational safety of the vehicle. There is an increased risk of an accident and injury.

Do not attempt to modify the wiring as well as electronic components or their software. Always have work on electrical and electronic components carried out at a qualified specialist workshop.

If you fail to adapt your driving style or if you are inattentive, the driving safety systems can neither reduce the risk of accident nor override the laws of physics. Driving safety systems are merely aids designed to assist driving. The driver is responsible for keeping a safe distance from the vehicle in front, for vehicle speed, for braking in good time and for staying in lane. The driving style should always be adjusted to the current street and weather conditions. An adequate safe distance must be maintained at all times.

You must observe the legal requirements for the country in which you are currently driving when operating information systems and communication devices integrated into the vehicle.

If you make any changes to the vehicle electronics, the general operating permit is rendered invalid.

! There is a risk of damage to the vehicle if:

- the vehicle becomes stuck, e.g. on a high kerb or an unpaved road
- you drive too fast over an obstacle, e.g. a kerb, a speed bump or a pothole in the road
- a heavy object strikes the underbody or parts of the chassis

In situations like this, the body, the underbody, chassis parts, wheels or tyres could be damaged without the damage being visible. Components damaged in this way can unexpectedly fail or, in the case of an accident, no longer withstand the strain they are designed to.

In such situations, have the vehicle checked and repaired immediately at a qualified specialist workshop. If on continuing your journey you notice that driving safety is impaired, pull over and stop the vehicle immediately, paying attention to road and traffic conditions. In such cases, consult a qualified specialist workshop.

The multimedia device is equipped with technical provisions to protect it against theft. Further information is available from any smart centre.

The functionality of a roof aerial (radio, DAB) may be impaired if roof carriers are used. Metallised retrofit film on windows may also affect radio and GPS reception and have a negative impact on all other aerial functions in the vehicle interior.

Declarations of conformity

Electromagnetic compatibility

The electromagnetic compatibility of the vehicle components has been checked and certified according to the currently valid version of UNECE standard UN-R10.

Declaration of conformity for two-way radio systems according to Directive 2014/53/EU

The components of the vehicle that receive and/or transmit radio waves are compliant with the basic requirements and all other

relevant regulations stipulated by Directive 2014/53/EU.

You can obtain further information from any Mercedes-Benz Service Centre.

In the following, you will find the addresses of radio component manufacturers which, due to their size or nature, do not allow this information to be indicated on the equipment.

Tyre pressure monitor sensors: Schrader Electronics Ltd., 11 Technology Park, Belfast Road, Antrim BT41 1QS, Northern Ireland

Transponder ring:

Visteon Electronics, 04 Rue Nelson Mandela, Zone Industrielle Borj Cedria, 2055 Bir El Bey, Tunisia

Remote keyless entry:

Visteon Electronics, 04 Rue Nelson Mandela, Zone Industrielle Borj Cedria, 2055 Bir El Bey, Tunisia

Alps Electric Europe GmbH, Ohmstraße 4, D-85716 Unterschleißheim, Germany

Radio:

Visteon Electronics, 04 Rue Nelson Mandela, Zone Industrielle Borj Cedria, 2055 Bir El Bey, Tunisia

Continental Automotive, 1 Rue de Clairefontaine, 78120 Rambouillet, France

Mobile communication and telemetry:

Ficosa International, Gran Via de Carles III 98, 08028 Barcelona, Spain

Radar:

Robert Bosch GmbH, Daimlerstraße 6, 71229 Leonberg, Germany

Windscreen unit:

car2go Group GmbH, Fasanenweg 15-17, 70771 Leinfelden-Echterdingen, Germany

TIREFIT kit

Copy of the original declaration of conformity:

VERIFICATION OF EMC COMPLIANCE

Verification No.: GZEM161000740001V

Applicant: ITW Global Tire Repair Europe GmbH

Address of Manufacturer: No. 11 Kuiqing Road, Qingxi Town, Dongguan City, China.

Factory: The same as manufacturer
 Address of Factory: The same as manufacturer
 Product: Air compressor
 Description:
 Model No: AEROB-DP

Sufficient samples of the product have been tested and found to be in conformity with Test Standards: EN 50498:2010

As shown in the Test Report Number(s): GZEM161000740001

This verification of EMC Compliance has been granted to the applicant based on the results of the tests, performed by laboratory of SGS-CSTC Standards Technical Services Co., Ltd. on the sample of the above-mentioned product in accordance with the provisions of the relevant specific standards under Directive 2014/30/EU. The CE mark as shown below can be used, under the responsibility of the manufacturer, after completion of an EU Declaration of Conformity and compliance with all relevant EU Directives.

Date: 2016-11-10

Signature: Kobe Jian

Type of radio device in the vehicle

Frequency range	Technology	Transmission output/magnetic field strength
125 kHz (119 kHz - 135 kHz)	Transponder ring	≤ 42 dBµA/m at 10 m
13.553 MHz - 13.567 MHz	Windscreen unit (vehicle access system for Car2Go)	≤ 42 dBµA/m at 10 m
433 MHz (433.05 MHz - 434.79 MHz)	Remote keyless entry Tyre pressure monitor	≤ 10 mW e.i.p.

Frequency range	Technology	Transmission output/magnetic field strength
2.4 GHz ISM waveband (2400 MHz – 2483.5 MHz)	Bluetooth®	≤ 100 mW e.i.r.p.
76 GHz – 77 GHz	76 GHz Radar	≤ 55 dBm peak e.i.r.p.

Diagnostics connection

The diagnostics connection is only intended for the connection of diagnostic equipment at a qualified specialist workshop.

WARNING

If you connect equipment to a diagnostics connection in the vehicle, it may affect the operation of vehicle systems. As a result, the operating safety of the vehicle could be affected. There is a risk of an accident.

Only connect equipment to a diagnostics connection in the vehicle, which is approved for your vehicle by Mercedes-Benz.

WARNING

Objects in the driver's footwell may restrict the clearance around the pedals or block a depressed pedal. This jeopardises the operating and road safety of the vehicle. There is a risk of an accident.

Stow all objects securely in the vehicle so that they do not get into the driver's footwell. Always fit the floor mats securely and as prescribed in order to ensure that there is always sufficient room for the pedals. Do not use loose floor mats and do not place several floor mats on top of one another.

! If the engine is switched off and a device is connected to a diagnostic connection, the battery may become discharged.

Qualified specialist workshop

A qualified specialist workshop has the necessary special skills, tools and qualifications to correctly carry out any necessary work on your vehicle. This particularly applies to work relevant to safety.

Observe the information contained in the Service Booklet.

Always have the following work carried out on your vehicle at a smart centre:

- work relevant to safety
- service and maintenance work
- repair work
- modifications, installations and conversions
- work on electronic components
- replacing the 12 V battery within the prescribed interval, at the latest every three years

You can obtain current information concerning the servicing of your vehicle at any time from a qualified specialist workshop, e.g. a smart centre.

Replacing the 12 V battery

Observe the notes on the 12 V battery.

smart recommends that you have the 12 V battery replaced at a qualified specialist workshop, e.g. at a smart centre.

If you intend to replace the battery yourself, please observe the following points:

- always replace a defective battery with a battery which fulfils the specific vehicle requirements
The vehicle is equipped with either an AGM (Absorbent Glass Mat) technology battery or a lithium-ion battery. Full vehicle functionality is only guaranteed with a battery of the same technology. smart recommends that you only use batteries of the same technology which have been tested and approved for your vehicle.
- carry over detachable parts, e.g. the breather hose, angled connecting piece or terminal cover from the battery which is being replaced
- make sure that the breather hose is always connected to the original opening on the battery side

Fit current or newly delivered cell caps. Otherwise, gases or battery acid may leak.

- make sure that the detachable parts are reconnected in the same way

Vehicle registration

smart may ask its smart centres to carry out technical inspections on certain vehicles. The quality or safety of the vehicle is improved as a result of the inspection.

smart is only able to notify the vehicle owner about vehicle inspections if smart has the vehicle registration data.

In the following cases, it is possible that a vehicle has not yet been registered in the owner's name:

- the vehicle was not purchased at an authorised specialist dealer
- the vehicle has not yet been examined at a smart centre

smart recommends registering the vehicle in a smart centre.

Notify smart as soon as possible if there is a change of address or if ownership of the vehicles changes. This can be done at a smart centre, for example.

High-voltage electrical system

Danger of electric shock

DANGER

The vehicle's high voltage electrical system is under high voltage. If you modify components in the vehicle's high-voltage electrical system or touch damaged components, you may be electrocuted. The components in the vehicle's high-voltage electrical system may be damaged in an accident, although the damage is not visible. There is a risk of fatal injury.

Do not touch any high-voltage components after an accident and never modify the vehicle's high-voltage electrical system. Have the vehicle towed away after an accident and the vehicle's high-voltage elec-

trical system checked by a qualified specialist workshop.



All of the vehicle's high-voltage electrical system components are marked with yellow warning stickers which warn you of the dangers of high voltages. The cables of the vehicle's high-voltage electrical system are orange in colour.

Observe the following before carrying out general work such as changing a bulb or checking the coolant level:

- the ignition is switched off
- the charging cable for charging the high-voltage battery is disconnected

Automatically switching off the vehicle's high-voltage electrical system

In order to prevent anyone coming into contact with high voltage, the high-voltage electrical system is generally switched off automatically in the following cases:

- the restraint systems are activated in the event of an accident
- an electrical short circuit is detected in the vehicle's high-voltage electrical system
- an electrical connection in the vehicle's high-voltage electrical system is disconnected

High-voltage battery

WARNING

In the event of a vehicle fire, the internal pressure of the high-voltage battery could exceed a critical value. In this case, flammable gas escapes through a vent valve in

the vehicle's underbody. The gas could ignite. There is a risk of injury.

In cases of unusual smells developing, smoke or burn marks, stop the charging process immediately.

Leave the danger area immediately. Secure the danger area at a suitable distance.

Contact a qualified specialist workshop.

WARNING

If the housing of the high-voltage battery has been damaged, electrolyte and gases may leak out. These are poisonous and caustic. There is a risk of injury.

Avoid contact with the skin, eyes or clothing. Immediately rinse electrolyte splashes off with water and seek medical attention straight away.

Correct use

If warning stickers are removed, you may fail to recognise certain dangers. Leave warning stickers in place.

The following are important sources of information in regard to vehicle use:

- safety notes in this Owner's Manual
- technical data in this Owner's Manual
- traffic rules and regulations
- laws and safety standards pertaining to motor vehicles

Implied warranty

! Follow the instructions in this manual about the proper operation of your vehicle as well as about possible vehicle damage. Damage to your vehicle that arises from culpable contraventions against these instructions is not covered either by the smart implied warranty or by the New or Used-Vehicle Warranty.

QR codes for rescue card

The QR code is affixed on the charge socket flap and on the door pillar (B-pillar), on the opposite side. In the event of an accident, rescue services can use the QR code to quickly determine the corresponding rescue card for a vehicle. The current rescue card contains the most important information about the vehicle in compact form, such as the routing of the electric cables. Further information: www.mercedes-benz.de/qr-code

Data stored in the vehicle

Electronic control units

Your vehicle is equipped with electronic control units. Some of them are necessary for your vehicle to function safely, some provide support when driving (driver assistance systems). In addition, your vehicle offers comfort or entertainment functions which are also made possible with electronic control units.

Electronic control units contain data memories which can permanently or temporarily store technical information on vehicle condition, component stress, service requirements as well as technical incidents and faults.

This information generally documents the condition of a component, a module, a system or of the environment such as:

- operating states of system components (e.g. fluid levels, battery status, tyre pressure)
- status messages of the vehicle or its individual components (e.g. wheel revolutions/speed, deceleration in movement, lateral acceleration, display of seat belts fastened)
- malfunctions and defects in key system components (e.g. the lights and brakes)
- information on incidents in which the vehicle is damaged
- reactions of the systems in specific driving situations (e.g. deployment of an air-bag, use of stability control systems)
- ambient conditions (e.g. temperature, rain sensor)

In addition to the provision of control unit functions, this data serves to detect and rectify faults as well as to optimise vehicle functions by the manufacturer. Most of this data is volatile and is only processed in the vehicle itself. Only a small proportion of the data is stored in event or error memories.

When service work is carried out on your vehicle, the technical data from the vehicle can be read out by service network staff (e.g. workshops, manufacturers) or third parties (e.g. breakdown services). Service work is, for example, repair work, maintenance, warranty claims and quality assurance measures. The data is read out via the legally prescribed connection for the diagnostics connection in the vehicle. The respective workshop of service network or third parties collect, process and use the data. The data documents technical states of the vehicle, help in finding errors and in improving quality and are transferred to the manufacturer if necessary. In addition, the manufacturer is subject to product liability. For this purpose, the manufacturer requires technical data from vehicles.

Error memories in the vehicle can be reset by a service outlet during repairs or service work.

Depending on the equipment selected, you can enter data in comfort and infotainment functions of the vehicle.

This includes, for example:

- multimedia data, such as music, films or photos for playback in an integrated multimedia system
- address book data for use in an integrated hands-free system or an integrated navigation system
- navigation destinations entered
- data on the use of Internet services

This data can be saved locally in the vehicle or it is located on a device which you have connected to the vehicle (e.g. smartphone, USB memory stick or MP3 player). If this data is saved in the vehicle, you can delete it at any time. Transfer of this data to third parties only occurs at your request, especially as part of online services according to the settings you have selected.

You can save comfort settings/individualisation in the vehicle and change them at any time.

Depending on the equipment, these include, for example:

- settings for seat and steering wheel positions
- suspension and air-conditioning settings
- individualisation such as interior lighting

If your vehicle is suitably equipped, you can connect your mobile phone or another mobile end device with the vehicle. You can operate these devices via the control elements integrated in the vehicle. Images and sound from the mobile phone can be played back via the multimedia system. At the same time, certain information is transferred to your mobile phone.

This includes, depending on the type of integration, for example:

- general vehicle status
- position data

This allows the use of selected mobile phone apps, e.g. navigation or music playback.

There is no further interaction between mobile phone and vehicle; in particular there is no active access to vehicle data. The provider of the app being used determines how the data may be further processed. Which settings you can adjust, if any, depends on the specific app and the operating system of your mobile phone.

Online services

Wireless network connection

If your vehicle has a wireless network connection, this will permit the exchange of data between your vehicle and further systems. The wireless network connection is enabled by a transmission and reception device belonging to the vehicle or via mobile end devices (e.g. mobile phones) you bring into the vehicle. Online functions can be used via this wireless network connection. These include online services and applications/apps, which are provided by the manufacturer or by other providers.

Manufacturer's own services

Regarding online services of the manufacturer, the individual functions are described by the manufacturer in a suitable place (e.g.

Owner's Manual, the manufacturer's website) along with the relevant data protection information. Personal identification data may be used to provide online services. The data exchange for this takes place via a secure connection, e.g. with the manufacturer's IT systems intended for the purpose. The collecting, processing, and use of personal identification data beyond the provision of services occurs exclusively on the basis of a legal permit or after due consent.

Generally, you can enable or disable the services and functions (which sometimes have associated costs). In some cases, this also applies to the whole data connection of the vehicle. Excluded from this are special legally prescribed functions and services.

Services of third parties

If it is possible to use online services from other providers, these services are the responsibility of the provider in question and subject to that provider's data protection conditions and terms of use. The manufacturer has no influence on the contents exchanged whilst using these services.

Please ask the respective service provider for details on the type, extent and purpose of the collection and use of personal data in the context of third party services.

Copyright information

Information on licenses of Free and Open-Source software used in the vehicle and the electronic components:

<http://www.mercedes-benz.com/opensource>

Cockpit

>> At a glance.

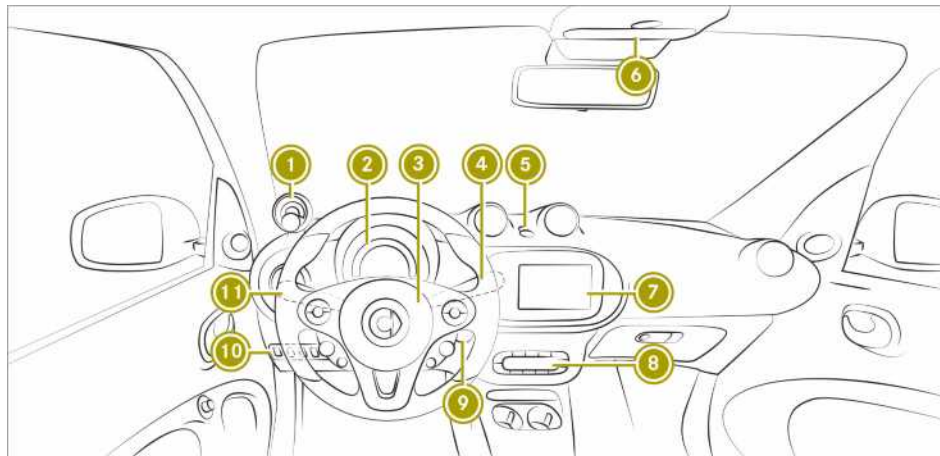

	Function	Page
①	Charge level display Power display	71 71
②	Instrument cluster	35
③	Horn	
④	Instrument cluster multi-function lever	107
	Windscreen wipers combination switch	88
⑤	Automatic locking feature	91
	Hazard warning lamps	170
⑥	Overhead control panel	33
⑦	smart Audio-System	112
	smart Media-System	120

	Function	Page
⑧	Climate control system control panel	94
⑨	Ignition lock	66
⑩	Control panel for: Lane Keeping Assist	74
	Parking aid	102
	Acoustic presence indicator	69
	Headlamp range adjustment	87
⑪	Lights combination switch	86

Multifunction steering wheel

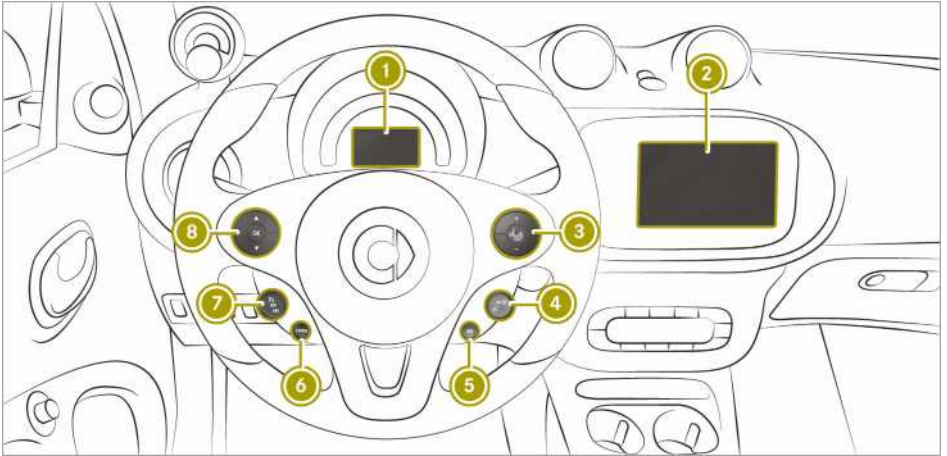

	Function	Page
①	Colour display of the instrument cluster Monochrome display of the instrument cluster	106 106
②	smart Audio-System smart Media-System	112 120
③	Only for instrument cluster with colour display: <input type="button" value="+"/> <input type="button" value="-"/> Adjusts the volume <input type="button" value="voice icon"/> Switches voice-operated control on or off and accepts or ends a call	120 120
④	<input type="button" value="SET +"/> Increases or stores the current speed <input type="button" value="SET -"/> Decreases current speed	76 76

	Function	Page
⑤	<input type="button" value="RES"/> Calls up the last speed stored	76
⑥	<input type="button" value="CANCEL"/> Interrupts cruise control or the limiter	76
⑦	<input type="button" value="cruise icon"/> Activates cruise control <input type="button" value="OFF"/> Deactivates cruise control or the limiter <input type="button" value="LIM"/> Activates limiter	76 76 76
⑧	Only for instrument cluster with colour display: <input type="button" value="up arrow"/> <input type="button" value="down arrow"/> Scrolls through menus <input type="button" value="OK"/> Confirms the selection	107 109

Centre console with drawer

>> At a glance.

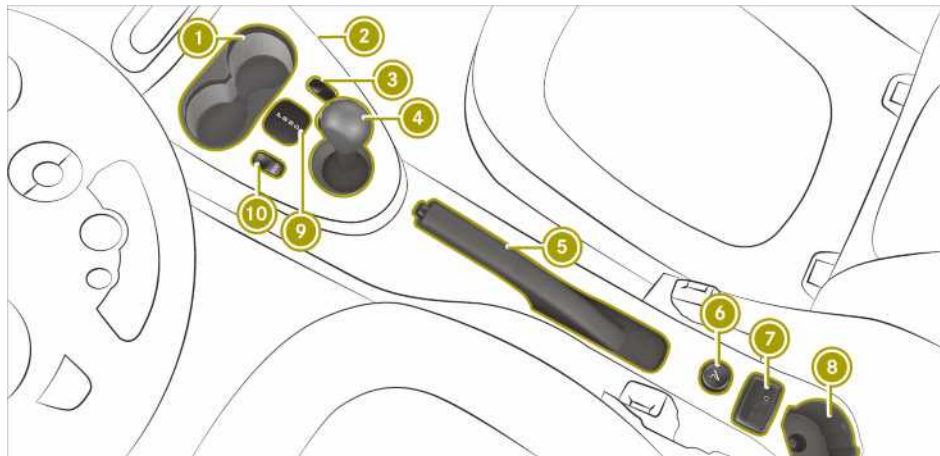

	Function	Page
①	Cup holders Ashtray	148 97
②	Drawer	148
③	Coin holder Opens and closes the fold- ing roof	93
④	Selector lever	68
⑤	Parking brake	67

	Function	Page
⑥	Cigarette lighter 12 V socket	97 98
⑦	smart Media-System: AUX port, USB port and SD card slot	120
⑧	Cup holders	148
⑨	Selector lever indicator	68
⑩	ECO mode	70

Overhead control panel

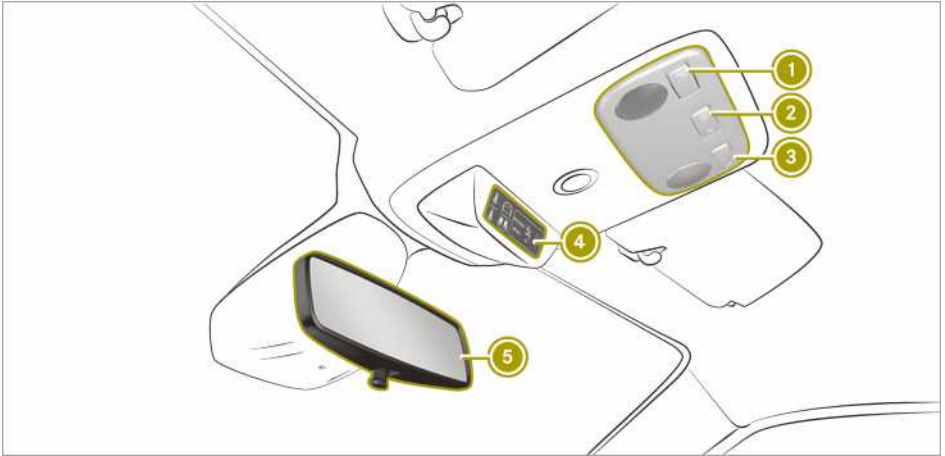

>> At a glance.

	Function	Page
①	Left-hand reading lamp	88
②	Interior lighting	88
③	Right-hand reading lamp	88

	Function	Page
④	PASSENGER AIRBAG indicator lamps Rear seat belt status indicator	41 40
⑤	Rear-view mirror	63

Door control panel

>> At a glance.

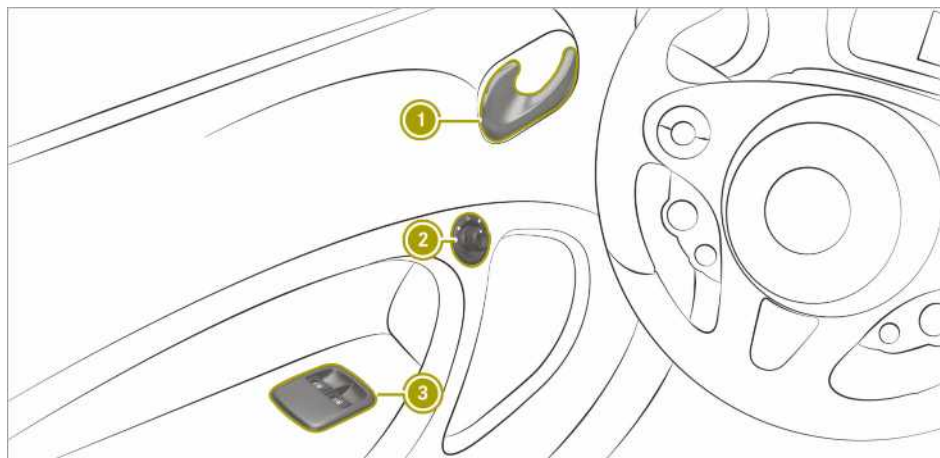

	Function	Page
①	Opens the door	91
②	Adjusts the exterior mirrors	64

	Function	Page
③	Opens and closes the side windows	93

Displays shown in the instrument cluster and the display

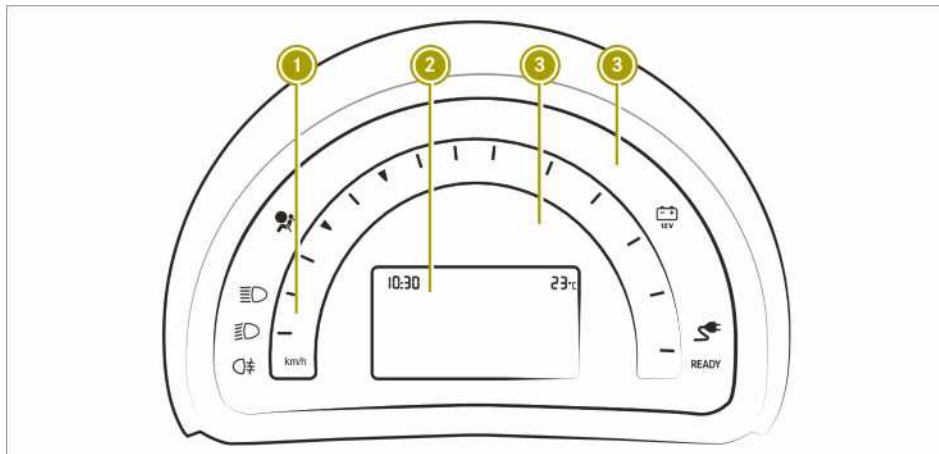

>> At a glance.

	Function	Page
①	Speedometer	
②	Display	
③	Warning and indicator lamps	
	Doors or tailgate	187
	Seat belts	188
	Restraint system	189
	Drive diagnostics	192
	Brakes	191
	ABS	195
	ESP®	58
	Tyre pressure monitor	197
	Power steering	200
	Collision warning	200
	Active Brake Assist	57

	Function	Page
	Lane Keeping Assist	201
	12 V battery	203
	Rear foglamp	87
	Foglamps	87
	Main-beam headlamps	86
	Dipped-beam headlamps	86
	Side lamps	87
	Charging cable	192
	Cruise control	202
LIM	Limiter	202
	Brake lights, rain or light sensors	203
	Next service due date	
	READY indicator	192
READY	READY indicator	203

Occupant safety

Restraint system

Protection provided by the restraint system

The restraint system comprises:

- Seat belt system
- Airbags
- Child restraint system
- Child seat securing systems

In the event of an accident, the restraint system can:

- reduce the risk of vehicle occupants coming into contact with parts of the vehicle interior.
- reduce the forces to which vehicle occupants are subjected

Only a seat belt which is worn correctly can provide the intended level of protection. The belt tensioners and/or airbags can complement a correctly worn seat belt depending on the detected accident situation. Belt tensioners and airbags are not necessarily deployed in every accident.

For the restraint system to provide its full protection, each occupant has to:

- have the seat belt fastened correctly
- be in an almost upright position with their back against the seat backrest
- sit with their feet resting on the floor, if possible
- if below 1.50 m in height, be secured using an additional restraint system suitable for your vehicle

However, no system available today can completely eliminate injuries and fatalities in every accident situation. In particular, seat belts and airbags generally do not protect against objects penetrating the vehicle from the outside. The risk of an injury resulting from airbag deployment cannot be ruled out entirely either.

Limited protection from restraint system

WARNING

If the restraint system is modified, it may no longer work as intended. The restraint system may then not perform its intended

protective function by failing in an accident or triggering unexpectedly, for example. There is an increased risk of injury, possibly even fatal.



Never modify parts of the restraint system. Do not attempt to modify the wiring as well as electronic components or their software.

If it is necessary to adjust the vehicle to accommodate a person with disabilities, contact a qualified specialist workshop. smart recommends that you use driving aids which have been approved specifically for your vehicle by smart.

Preparing the restraint system for operation

When the ignition is switched on, the  restraint system warning lamp lights up during the self-check. It goes out no later than a few seconds after the vehicle is started. The components of the restraint system are then ready for operation.

Restraint system malfunctions

- The restraint system warning lamp  does not light up when the ignition is switched on.
- The restraint system warning lamp  is constantly lit or lights up repeatedly when driving.

In the event of an accident, the vehicle's high-voltage electrical system may not be deactivated as intended if there is a malfunction in the restraint system.

DANGER

If the restraint system is malfunctioning, restraint system components may be triggered unintentionally or may not deploy as intended during an accident. This may affect the seat belt tensioner or airbag, for example. Furthermore, in the event of an accident, the vehicle's high-voltage electrical system may not be deactivated as intended. You may be electrocuted if you touch the damaged components of the vehicle's high-voltage electrical system.

This poses an increased risk of injury or even fatal injury.

Have the restraint system checked and repaired immediately at a qualified specialist workshop. After an accident, switch off the ignition immediately and remove the key from the ignition lock.

Restraint system response during an accident

How the restraint system works depends on the severity of the impact detected and the apparent type of accident:

- head-on collision
- rear collision
- side impact
- overturn¹

The activation threshold for the restraint system components is determined based on the analysis of the sensor values measured at various points in the vehicle. This process is pre-emptive in nature. The triggering process of the restraint system components should take place in good time at the start of the collision.

Factors which can only be seen and measured after a collision has occurred do not play a decisive role in the deployment of an airbag, nor do they provide an indication of airbag deployment.

The vehicle may be deformed significantly without an airbag being deployed. This is the case if only parts which are relatively easily deformed are affected and the rate of vehicle deceleration is not high. Conversely, an airbag may be deployed even though the vehicle suffers only minor deformation. If, for instance, very rigid car parts such as longitudinal body members are hit, the rate of vehicle deceleration may be sufficient.

The restraint system components can be activated or triggered independently of each other:

Components	Detected trigger situation
Belt tensioners	Frontal collision, rear collision, side impact, overturn ¹
Driver's airbag, front passenger front airbag and knee airbag	Head-on collision
Sidebag	Side impact
Windowbag	Side impact, overturn ¹ , frontal collision

WARNING

After the airbag deploys, the airbag parts are hot. There is a risk of injury.

Do not touch the airbag parts. Have a deployed airbag replaced at a qualified specialist workshop as soon as possible.

- i** smart recommends that you have the vehicle towed to a qualified specialist workshop after an accident. Take this into account, particularly if a belt tensioner was triggered or an airbag was deployed.

If the belt tensioners are triggered or an airbag is deployed, you will hear a bang, and a small amount of powder may also be released:

- the bang will not usually affect your hearing.
- in general, the powder released is not hazardous to health but may cause short-term breathing difficulties to persons suffering from asthma or other pulmonary conditions.

Provided it is safe to do so, leave the vehicle immediately or open the window in order to prevent breathing difficulties.

¹ Only for certain countries.

Seat belts

Protection provided by seat belts

Always fasten seat belts correctly before commencing your journey. A seat belt can only provide maximum protection when worn correctly.

WARNING

If the seat belt is worn incorrectly, it cannot perform its intended protective function. Furthermore, an incorrectly worn seat belt can cause additional injuries, e.g. in the event of an accident, heavy braking or sudden changes of direction. There is an increased risk of injury, possibly even fatal.

Always ensure that all vehicle occupants have their seat belts fastened correctly and are sitting properly.

Always observe the notes on correct driver's seat position (▷ page 60) and seat adjustment (▷ page 61).

Every car occupant must observe the following notes to ensure a properly worn seat belt can provide full protection.

- The seat belt must:
 - not be twisted and must be tight and fit snugly across your body
 - be routed across the centre of the shoulder and as low down across your hips as possible
- the shoulder section of the belt should not touch your neck nor be routed under your arm or behind your back.
- avoid wearing bulky clothing, e.g. a winter coat.
- press the lap belt down into your hip joints and pull taut by the shoulder section of the belt. The lap belt must never be routed across your stomach or abdomen.
- never route the seat belt across sharp, pointed, abrasive or fragile objects.
- only one person per seat belt. Infants and children must never travel sitting on the lap of a vehicle occupant.
- never secure objects with a seat belt if the seat belt is also being used by one of the vehicle's occupants. Always observe the

notes on "Loading the vehicle" for securing objects, luggage or loads (▷ page 149).

Also make sure that objects are never placed between an occupant and the seat, e.g. a cushion.

If children are travelling in the vehicle, be sure to observe the instructions and safety notes on "Children in the vehicle" (▷ page 42).

Limited protection from seat belts

WARNING

The seat belt does not offer the intended level of protection if you have not moved the backrest to an almost vertical position. When braking or in the event of an accident, you could slide underneath the seat belt and sustain abdomen or neck injuries, for example. This poses an increased risk of injury or even fatal injury.

Adjust the seat properly before beginning your journey. Always ensure that the backrest is in an almost vertical position and that the shoulder section of your seat-belt is routed across the centre of your shoulder.

WARNING

Persons under 1.50 m tall cannot wear the seat belts correctly without an additional suitable restraint system. If the seat belt is worn incorrectly, it cannot perform its intended protective function. Furthermore, an incorrectly worn seat belt can cause additional injuries, e.g. in the event of an accident, heavy braking or sudden changes of direction. There is an increased risk of injury, possibly even fatal.

Always secure persons less than 1.50 m tall in additional suitable restraint systems.

⚠ WARNING

Seat belts cannot protect as intended, if:

- they are damaged, have been modified, are extremely dirty, bleached or dyed
- the seat belt buckle is damaged or extremely dirty
- modifications have been made to the belt tensioners, belt anchorages or inertia reels

Seat belts may sustain non-visible damage in an accident, e.g. due to glass splinters. Modified or damaged seat belts can tear or fail, for example in the event of an accident. Modified seat belt tensioners may be deployed unintentionally or not function as intended. There is an increased risk of injury, possibly even fatal.

Never modify seat belts, seat belt tensioners, seat belt anchorages and inertia reels. Ensure that seat belts are not damaged or worn and are clean. After an accident, have the seat belts checked immediately at a qualified specialist workshop.

smart recommends that you only use seat belts that have been approved specifically for your vehicle by smart.

⚠ WARNING

Pyrotechnical belt tensioners which have been triggered are no longer operational and therefore cannot protect as intended. There is an increased risk of injury, possibly even fatal.

Have pyrotechnic belt tensioners which have been triggered replaced at a qualified specialist workshop immediately.

smart recommends that you have the vehicle towed to a qualified specialist workshop after an accident.

- ! Make sure that the seat belt is fully rolled up. Otherwise, the seat belt or belt tongue will be trapped in the door or in the seat mechanism. This could damage the door, the door trim panel and the seat belt. Damaged seat belts can no longer fulfil their

protective function and must be replaced. Visit a qualified specialist workshop.

Fastening and adjusting the seat belts

If the seat belt is pulled quickly or suddenly, the inertia reel locks. The belt strap cannot be pulled out further.

- ! If the co-driver's seat is not occupied, do not engage the seat belt tongue in the buckle on the co-driver's seat. Otherwise, in the event of an accident the belt tensioner could be triggered in addition to other systems and would need to be replaced.



- ▶ Always insert seat belt tongue ② into belt buckle ① that belongs to the seat.
- ▶ Slide the belt sash guide into the required position.
 - To raise:** slide upwards at the ring.
 - To lower:** press the belt guide release and slide downwards at the ring.
- ▶ Make sure that the belt sash guide is engaged.

Releasing the seat belts

- ▶ Press the release button in the belt buckle and guide the seat belt back by the belt tongue.

Belt warning for the driver and front passenger

The  seat belt warning lamp in the instrument cluster reminds you that all vehicle occupants must fasten their seat belts correctly.

A warning tone may also sound.

As soon as the driver and co-driver fasten their seat belts, the seat belt warning goes out.

Rear seat belt status indicator

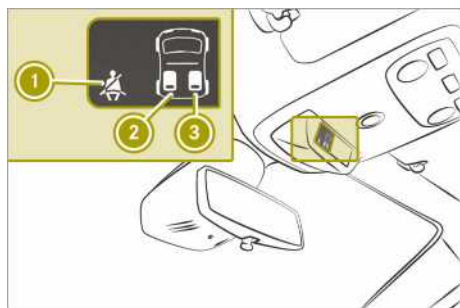

- ① Seat belt warning lamp
- ② Rear left-hand seat belt status indicator
- ③ Rear right-hand seat belt status indicator

The rear seat belt status indicator informs you which rear seat belt is not fastened.

You will recognise the status of the rear seat belt from the following colour:

- Red – seat belt not fastened
- Green – seat belt fastened

When you drive off and have reached a speed of approximately 10 km/h the lamps go out after approximately 30 seconds.

Airbags

Overview of airbags

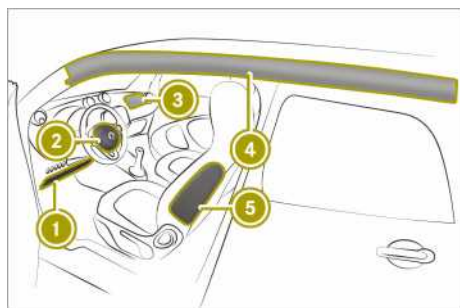

The installation location of an airbag is identified by the AIRBAG symbol.

When deployed, an airbag may increase protection for the corresponding vehicle occupant.

	AIRBAG	Possible protection for:
①	Driver's knee bag	Thigh, knee, lower leg
②	Driver's air-bag	Head and thorax
③	Front passenger front airbag	Head and thorax
④	Windowbag	Head
⑤	Sidebag	Thorax and pelvis

The front passenger front airbag can be deployed in an accident only if the PASSENGER AIR BAG ON indicator lamp is lit. If the front passenger seat is occupied, make sure both before and during the journey that the status of the front passenger front airbag is correct (▷ page 41).

Protection provided by the airbags

Depending on the accident situation, an airbag supplements a correctly worn seat belt and can increase protection.

WARNING

If you deviate from the correct seat position, the airbag cannot perform its intended protective function and can even cause additional injuries when deployed. There is an increased risk of serious or even fatal injuries.

In order to avoid such risks, always ensure that all vehicle occupants:

- fasten their seatbelts correctly, including pregnant women
- are seated correctly and maintain the furthest possible distance from the airbags
- observe the following notes

Always ensure that there are no objects located between the airbag and the vehicle occupant.

To avoid risks resulting from a deployed airbag:

- adjust the seats properly before beginning your journey. Move the driver's and co-driver's seats as far back as possible
Always observe the information on the correct driver's seat position (▷ page 60).
- hold the steering wheel by the rim only. This allows the airbag to deploy fully
- always lean against the backrest while driving. Do not lean forwards or against the door or side window. Otherwise, you are in the airbags' deployment area
- feet should always be placed on the ground. Do not place your feet on the dashboard, for example. Otherwise, your feet are in the airbag's deployment area
- when travelling with children in the vehicle, observe the additional notes (▷ page 42)
- always stow objects correctly and securely

Objects in the vehicle interior may prevent the airbag from functioning correctly. Therefore, always make sure that:

- there are no people, animals or objects between the vehicle occupants and the airbag
- there are no objects between the seat, door and B-pillar
- there are no hard objects, e.g. coat hangers, hanging on the grab handles or coat hooks
- there are no accessories, such as drinks can holders, attached in the airbag's deployment area, e.g. on doors, side windows or side trim panels
- there are no heavy, sharp-edged or fragile objects in the pockets of your clothing. Stow such objects in a suitable place

Limited protection from airbags

WARNING

If you modify an airbag cover or affix objects such as stickers to it, the airbag can no longer function correctly. There is an increased risk of injury.

Never modify an airbag cover or affix objects to it.

WARNING

Unsuitable seat covers may obstruct or even prevent deployment of the airbags integrated into the seats. The airbags may then fail to protect the vehicle occupants as intended. There is an increased risk of injury, possibly even fatal.

Use only seat covers which have been specifically approved for the respective seat by smart.

WARNING

Sensors to control the airbags are located in the doors. Modifications or work not performed correctly to the doors or door panelling, as well as damaged doors, can lead to the function of the sensors being impaired. The airbags might therefore not function properly any more. Consequently, the airbags cannot protect vehicle occupants as they are designed to do. This poses an increased risk of injury.

Never modify the doors or parts of the doors. Always have work on the doors or door panelling carried out at a qualified specialist workshop.

WARNING

An airbag that has been deployed once cannot provide any further protection and, in the event of an accident, can no longer perform its intended protective function. There is an increased risk of injury.

Have the vehicle towed to a qualified specialist workshop to have the deployed airbag replaced.

Have deployed airbags replaced immediately.

Status of the front passenger front airbag

PASSENGER AIR BAG indicator lamps

The front passenger front airbag can be enabled or disabled using the airbag-off switch in the instrument panel on the front passenger side (▷ page 51).

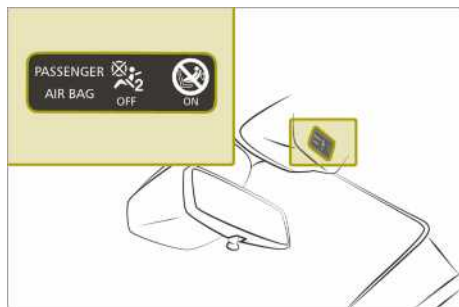

The PASSENGER AIR BAG OFF and PASSENGER AIR BAG ON indicator lamps are part of the front passenger front airbag deactivation system.

The indicator lamps display the status of the front passenger front airbag:

- PASSENGER AIR BAG OFF lights up: the front passenger front airbag is deactivated. It will then not be deployed in the event of an accident.
- PASSENGER AIR BAG ON lights up: the front passenger front airbag is activated. The front passenger front airbag may deploy during an accident.

If the front passenger seat is occupied, make sure that the status of the front passenger front airbag is correct depending on the situation both before and during the journey:

- **Children in a child restraint system:** whether the front passenger front airbag should be enabled or disabled depends on the child restraint system fitted and the age and size of the child. Be sure to observe the notes on "Children in the vehicle" (> page 42). There, you will also find information on rearward- or forward-facing child restraint systems on the front passenger seat.
- **All other persons:** the PASSENGER AIR BAG ON indicator lamp must be lit. The front passenger front airbag is activated. Be sure to read the notes on "Seat belts" (> page 38) and "Airbags" (> page 40). There, you can also find information on the correct seat position.

Observe the information on the airbag deactivation system of the front passenger front airbag (> page 51).

Travelling safely with children in the vehicle

Observe carefully when children travelling in the vehicle

Being consistent

- **i** Be sure to observe the safety notes relevant to the situation. In doing so, you will be able to identify possible risks and avoid dangers when children are travelling in the vehicle (> page 43).

Bear in mind that negligence when securing the child in the child restraint system may have serious consequences. Always be consistent and secure a child carefully before each journey.

To improve protection for children younger than twelve years old and under 1.50 m in height, smart recommends you always observe the following notes:

- Always secure the child in a child restraint system suitable for your smart vehicle.
- The child restraint system must be appropriate to the age, weight and size of the child.
- The vehicle seat must be suitable for the child restraint system to be fitted (> page 46).

Accident statistics show that children secured on the rear seats are safer than children secured on the front seats. For this reason, smart strongly advises that you fit a child restraint system on a rear seat.

The generic term child restraint system

The generic term child restraint system is used in this Owner's Manual. A child restraint system is, for example:

- a baby car seat
- a rearward-facing child seat
- a forward-facing child seat
- a child booster seat with a backrest and seat belt guides

The child restraint system must be appropriate to the age, weight and size of the child.

Observing laws and regulations

Be sure to observe the legal requirements when using a child restraint system in the vehicle.

Ensure that the child restraint system is approved in accordance with the valid test specifications and guidelines. Further information can be obtained at a qualified specialist workshop. smart recommends that you use a smart Centre.

Use only approved child restraint systems

Only child restraint systems that meet the following UNECE standards are permitted for use in the vehicle:

- UN-R44
- UN-R129 (i-Size child restraint systems)

Information about the approval categories for child restraint systems and details on the approval label on the child restraint system (▷ page 46).

Detecting risks, avoiding danger

Securing systems for child restraint systems in the vehicle

Only use the following securing systems for child restraint systems:

- the ISOFIX or i-Size securing rings
- the vehicle's seat belt system
- Top Tether anchorages

Preferably, fit an ISOFIX or i-Size child restraint system.

The risk of incorrectly fitting the child restraint system can be reduced by simply fitting it on the securing rings of the vehicle.

When the child is secured using the safety belt integrated in the ISOFIX or i-Size child restraint system, be sure to observe the maximum permissible weight of the child and child restraint system together (▷ page 49).

The advantage of a rearward-facing child restraint system

Babies or infants should preferably travel in a suitable rearward-facing child restraint system. In this case, the child is seated in the

opposite direction to the direction of travel and is facing backwards.

Babies and infants have comparatively poorly developed neck muscles in relation to the size and weight of their head. A rearward-facing child restraint system can reduce the risk of injury to the cervical spine in an accident.

Secure the child restraint system correctly at all times

WARNING

If the child restraint system is incorrectly fitted on the seat position suitable for this purpose, it cannot perform its intended protective function. In the event of an accident, sharp braking or a sudden change in direction, the child may not be held securely. There is an increased risk of serious or even fatal injuries.

Observe the manufacturer's installation instructions and the correct use for the child restraint system. Make sure that the entire surface of the child restraint system is resting on the seat surface. Never place objects under or behind the child restraint system, e.g. cushions. Only use child restraint systems with the original cover designed for them. Only replace damaged covers with genuine covers.

WARNING

If the child restraint system is fitted incorrectly or is not secured, it can come loose in the event of an accident, heavy braking or a sudden change in direction. The child restraint system could be thrown about, striking vehicle occupants. There is an increased risk of injury, possibly even fatal.

Always fit child restraint systems properly, even if they are not being used. Make sure that you observe the child restraint system manufacturer's installation instructions.

- Be sure to observe the installation and operating instructions provided by the

manufacturer for the child restraint system being used as well as the vehicle-specific notes at all times:

- Fitting an ISOFIX or i-Size child restraint system to the rear seat (▷ page 49).
- Securing the child restraint system with the seat belt on the rear seat (▷ page 54).
- Securing the child restraint system with the seat belt on the front passenger seat (▷ page 55). Observe the specific notes on rearward-facing and forward-facing child restraint systems.

If the front passenger seat is occupied, make sure that the status of the front passenger front airbag is correct depending on the situation both before and during the journey.

- Observe the warning labels in the vehicle interior and on the child restraint system.
- Also secure Top Tether, if available.

Do not modify the child restraint system

WARNING

If you modify a child restraint system or affix objects to it, e.g. toys or unsuitable accessories, the child restraint system may no longer function properly. This poses an increased risk of injury.

Never modify a child restraint system. Only affix accessories which have been specially approved for this child restraint system by the child restraint system's manufacturer.

smart recommends you use smart care products to clean child restraint systems recommended by smart.

Only use child restraint systems which are not damaged

WARNING

Child restraint systems or their securing systems that have been damaged or subjected to a load in an accident cannot perform their intended protective function. In the event of an accident, sharp braking or a

sudden change in direction, the child may not be held securely. There is an increased risk of serious or even fatal injuries.

Immediately replace child restraint systems that have been damaged or subjected to a load in an accident. Have the child restraint securing systems checked in a qualified specialist workshop before fitting a child restraint system again.

Avoiding direct sunlight

WARNING

If the child restraint system is placed in direct sunlight, the parts could become very hot. Children could suffer burns by touching these parts, in particular on the metallic parts of the child restraint system. There is a risk of injury.

If you and your child leave the vehicle, always make sure that the child restraint system is not in direct sunlight. Cover it with a blanket, for example. If the child restraint system has been exposed to direct sunlight, leave it to cool down before securing the child in it. Never leave children unattended in the vehicle.

Observe the following when stopping or parking

WARNING

If you leave children unattended in the vehicle, they may be able to set the vehicle in motion if, for example, they:

- release the parking brake
- shift the automatic transmission out of park position **P**
- start the engine

In addition, they may operate vehicle equipment and become trapped. There is a risk of an accident and injury.

When leaving the vehicle, always take the key with you and lock the vehicle. Never leave children unattended in the vehicle.

⚠ WARNING

If persons (particularly children) are exposed to heat or cold for a prolonged period, there is a risk of serious or even

fatal injuries. Never leave persons (particularly children) unattended in the vehicle.

Overview of recommended child restraint systems

The smart forfour is equipped with a manual front passenger front airbag deactivation system.

► Before using a rearward-facing child restraint system on the front passenger seat, disable the front passenger front airbag (▷ page 51).

i You can obtain further information about the correct child restraint system from a qualified specialist workshop. smart recommends that you use a smart Centre.

Securing with ISOFIX

Weight group Size class	Model ² Approval number	Order number ³
Group 0+: up to 13 kg and up to approximately 15 months Size category E	BABY SAFE plus E1 04 301 146	B6 6 86 8224
Group I: 9–18 kg Size category B1	DUO plus E1 04 301 133	A 000 970 17 02

Securing with the vehicle seat belt

Weight group	Type ² Approval number	Order number ³
Group 0: up to 10 kg and up to approximately 6 months	BABY SAFE plus II E1 04 301 146	A 000 970 13 02
Group 0+: up to 13 kg and up to approximately 15 months	BABY SAFE plus II E1 04 301 146	A 000 970 13 02
Group I: 9–18 kg and from approximately 9 months to 4 years	DUO plus E1 04 301 133	A 000 970 17 02



² Manufacturer: Britax Römer.

³ With colour code 9H95.

Weight group	Type ² Approval number	Order number ³
Group II/III: 15–36 kg and from approximately 4–12 years	KIDFIX E1 04 301 198	A 000 970 20 02
Group II/III: 15–36 kg and from approximately 4–12 years	KIDFIX XP E1 04 301 304	A 000 970 23 02

Suitable seats in the vehicle for installing a child restraint system

Securing systems for child restraint systems

Vehicle seat		
Left/right rear seat	Preferred securing system:  ISOFIX child seat securing system (▷ page 48) or  i-Size child seat securing system (▷ page 49)  Also secure Top Tether if available (▷ page 51)	Alternative securing system: <ul style="list-style-type: none"> • Vehicle seat belt (▷ page 53)
Front passenger seat	Securing system: <ul style="list-style-type: none"> • Vehicle seat belt (▷ page 53) 	Be sure to observe: <ul style="list-style-type: none"> • If the front passenger seat is occupied, make sure that the status of the front passenger front airbag is correct depending on the situation both before and during the journey.

Permitted categories for child restraint systems

Use only approved child restraint systems

Only child restraint systems that meet the following UNECE standards are permitted for use in the vehicle:

- UN-R44
- UN-R129 (i-Size child restraint systems)

² Manufacturer: Britax Römer.

³ With colour code 9H95.

Identification on the child restraint system

Information about the approval category, weight category and approval number, for example, is on the approval label on the child restraint system.

Depending on the approval category of the child restraint system, there may be further information, e.g. the ISOFIX size category.

Approval categories in accordance with UN-R44



Example of an approval label

- **Universal:** child restraint systems in the "Universal" category are approved for installation in vehicles. They can be used, in accordance with overviews of the suitability of seats for securing child restraint systems, on seats labelled U, UF or IUF. The designation IUF refers to an ISOFIX child restraint system in the "Universal" category. These child restraint systems must also be secured using Top Tether or a supporting bracket.
- **Semi-Universal:** child restraint systems in the "semi-universal" category may only be used if the vehicle and the seat are listed in the child restraint system manufacturer's vehicle model list.
- **Vehicle-specific:** child restraint systems in the "vehicle-specific" category may only be used if the vehicle and the seat are listed in the child restraint system manufacturer's vehicle model list.

Approval categories in accordance with UN-R129



Example of an approval label

- **i-Size:** child restraint systems in the "i-Size" category are approved for installation in vehicles with i-Size securing rings. They can be used, in accordance with overviews of the suitability of seats for securing child restraint systems, on seats labelled i-U. The designation i-U refers to an i-Size child restraint system in the "Universal" category. These child restraint systems must also be secured using Top Tether or a supporting bracket.

Observe the suitability of vehicle seats

Depending on the approval category, there are forward-facing and/or rearward-facing child restraint systems. Usage may be limited for certain vehicle seats.

- Suitability of seats for securing ISOFIX child restraint systems (▷ page 48)
- Suitability of seats for securing i-Size child restraint systems (▷ page 49)
- Suitability of seats for securing a belt-secured child restraint system (▷ page 53)

Securing the ISOFIX or i-Size child restraint system

Suitability of the seats for attaching ISOFIX child restraint systems

>> Safety.

	ISOFIX identification
	<p>ISOFIX is a standardised securing system for special restraint systems.</p> <ul style="list-style-type: none"> • This symbol indicates which seats are suitable for securing an ISOFIX child restraint system in accordance with UN-R44. • Only secure child restraint systems approved by UN-R44 in accordance with the following ISOFIX tables.

Carry cot

Size class	Equipment	Left/right rear seat
F	ISO/L1	X
G	ISO/L2	X
		X Not suitable for an ISOFIX child restraint system in this weight category and/or size category.

Weight category 0 (up to 10 kg and up to approximately 6 months)

Size class	Equipment	Left/right rear seat
E	ISO/R1	IL
		IL Suitable for ISOFIX child restraint systems in accordance with the table in "Overview of recommended child restraint systems", or if the vehicle and the seat are listed in the child restraint system manufacturer's vehicle model list.

Weight category 0+ (up to 13 kg and up to approximately 15 months)

Size class	Equipment	Left/right rear seat
E	ISO/R1	IL
D	ISO/R2	IL
C	ISO/R3	X
		<p>IL Suitable for ISOFIX child restraint systems in accordance with the table in "Overview of recommended child restraint systems", or if the vehicle and the seat are listed in the child restraint system manufacturer's vehicle model list.</p> <p>X Not suitable for an ISOFIX child restraint system in this weight category and/or size category.</p>

Weight category I (9–18 kg and approximately 9 months to 4 years)

Size class	Equipment	Left/right rear seat
D	ISO/R2	IL
C	ISO/R3	X
B	ISO/F2	IUF
B1	ISO/F2X	IUF
A	ISO/F3	IUF
		IL Suitable for ISOFIX child restraint systems in accordance with the table in "Overview of recommended child restraint systems", or if the vehicle and the seat are listed in the child restraint system manufacturer's vehicle model list. X Not suitable for an ISOFIX child restraint system in this weight category and/or size category. IUF Suitable for forward-facing ISOFIX child restraint systems in the "Universal" category in this weight category.

Suitability of the seats for attaching i-Size child restraint systems

	i-Size identification
	i-Size is a standardised securing system for special restraint systems. <ul style="list-style-type: none"> • This symbol indicates which seats are suitable for securing an i-Size child restraint system in accordance with UN-R129. • Child restraint systems which have been approved in accordance with the following may be secured: <ul style="list-style-type: none"> - UN-R44 in accordance with the ISOFIX tables (> page 48) - UN-R129 in accordance with the following i-Size table

	Front passenger seat	Left/right rear seat
i-Size child restraint system	X	i-U
	X Not suitable for an ISOFIX child restraint system in this weight category and/or size category.	i-U Suitable for forward-facing and rearward-facing i-Size child restraint systems in the "Universal" category.

Installing an ISOFIX or i-Size child restraint system on the rear seat

 **WARNING**

For ISOFIX or i-Size child restraint systems, where the child is secured using the integrated seat belt of the child restraint system, the permissible gross weight of the child and the child restraint system is 33 kg.

If the child together with the child restraint system weighs more than 33 kg, ISOFIX or i-Size child restraint systems with integrated seat belt no longer offer sufficient protection. ISOFIX or i-Size child seat securing systems may be overloaded and will not be able to restrain the child, for example, in the event of an accident. This poses an increased risk of injury or even fatal injury.

If the child together with the child restraint system weighs more than 33 kg, only use ISOFIX or i-Size child restraint systems with which the child is secured with the vehicle seat belt. Also secure the child restraint system with the Top Tether belt, if available.

Always observe the information on the weight of the child restraint system:

- in the installation and operating instructions provided by the manufacturer for the child restraint system being used
- on the label of the child restraint system, if present

Regularly check that the maximum permissible weight of the child and child restraint system together is still complied with.

When fitting a child restraint system, be sure to observe the following:

- ✓ Be sure to observe the correct use and the suitability of seats for securing a child restraint system.
ISOFIX child seat securing system (▷ page 48)
i-Size child seat securing system (▷ page 49)
- ✓ Be sure to observe the installation and operating instructions provided by the manufacturer for the child restraint system being used.
- ✓ Make sure that the child's feet do not touch the front seat. If necessary, move the front seat forwards slightly.



When fitting an ISOFIX child restraint system, also observe the following:

- ✓ **When using a category 0/0+ baby car seat and a category I, rearward-facing child restraint system on a rear seat:** adjust the front seat so that the seat does not touch the child restraint system.
- ✓ For certain child restraint systems in weight category II or III, there may be restrictions on the maximum size setting, e.g. due to possible contact with the roof.
- ✓ The child restraint system must not be put under strain between the roof and

the seat cushion and/or be fitted facing the wrong direction.

- ✓ The child restraint system must not be put under strain by the head restraint. Adjust the head restraints as appropriate.



When fitting an i-Size child restraint system, also observe the following:

- ✓ **When using a rearward-facing child restraint system:** adjust the front seat so that it does not touch the child restraint system.
- ✓ **When using a forward-facing child restraint system:** remove the head restraint from the respective seat, if possible. In addition, the seat backrest of the child restraint system must, as far as possible, lie flat against the backrest of the vehicle seat.

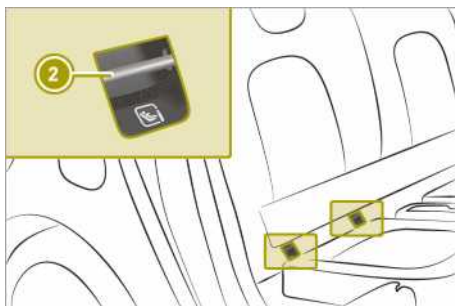
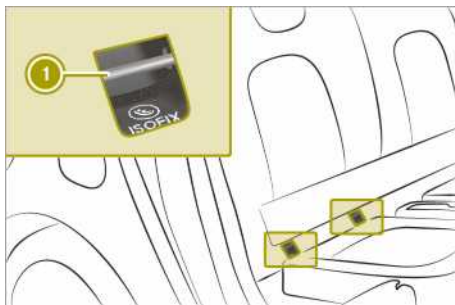

- ① ISOFIX securing rings
- ② i-Size securing rings

Before every trip, make sure that the ISOFIX child restraint system or the i-Size child restraint system is engaged correctly in both ISOFIX or i-Size securing rings.

- ▶ Fit the ISOFIX or i-Size child restraint system on both securing rings of the vehicle.

Securing Top Tether

⚠ WARNING

If the rear seat backrests are not locked, they could fold forwards in the event of an accident, heavy braking or sudden changes of direction. As a result, child restraint systems cannot perform their intended protective function. Rear seat backrests that are not locked can also cause additional injuries, e.g. in the event of an accident. This poses an increased risk of injury or even fatal injury.

Always lock rear seat backrests after fitting a Top Tether belt. Observe the lock verification indicator. Adjust the rear seat backrests so that they are in an upright position.

Ensure that the red lock verification indicator on the loop at the top of the rear bench seat is no longer visible.



If the child restraint system is equipped with a Top Tether belt: Top Tether can reduce the risk of injury. The Top Tether belt provides an additional connection between the child restraint system secured with ISOFIX or i-Size and the vehicle.

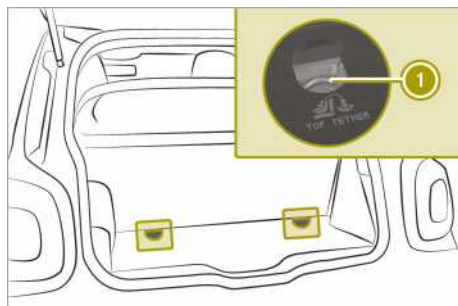

Top Tether anchorage ① is fitted to the luggage compartment floor behind each rear seat.

- ▶ Fit the ISOFIX or i-Size child restraint system with Top Tether. Be sure to comply

with the child restraint system manufacturer's installation instructions when doing so.

- ▶ Move the head restraint upwards.

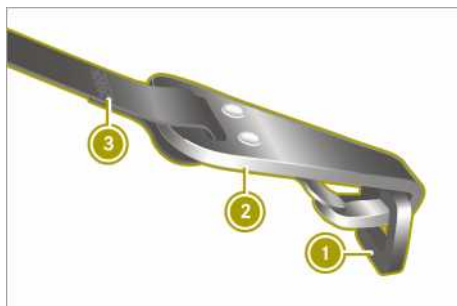

- ▶ Guide Top Tether belt ③ under the head restraint between the two head restraint bars.
- ▶ Guide Top Tether belt ③ between the backrest and parcel shelf into the luggage compartment. Remove the parcel shelf if necessary (▷ page 149).
- ▶ Hook Top Tether hook ② of Top Tether belt ③ into Top Tether anchorage ①. Lift up the carpet a little if necessary. Ensure that:

- Top Tether hook ② is hooked into Top Tether anchorage ① as shown
- Top Tether belt ③ is not twisted
- Top Tether belt ③ is routed between the backrest and the parcel shelf if the parcel shelf is fitted

- ▶ Tension Top Tether belt ③. Be sure to comply with the child restraint system manufacturer's installation instructions when doing so.
- ▶ If necessary, move the head restraint back down again slightly. Make sure that you do not interfere with the correct routing of Top Tether belt ③.

Disabling or enabling the front passenger front airbag

⚠ WARNING

If the PASSENGER AIRBAG OFF indicator lamp is lit, the front-passenger front air-

bag is disabled. It will not be deployed in the event of an accident and cannot perform its intended protective function. A person in the front-passenger seat could then, for example, come into contact with the vehicle's interior, especially if the person is sitting too close to the dashboard. This poses an increased risk of injury or even fatal injury.

In this case the front-passenger seat may not be used. You may only transport a child on the front-passenger seat if they are seated in a suitable rearward or forward-facing child restraint system. Always observe the information about suitable positioning of the child restraint system in this Owner's Manual as well as the child restraint system manufacturer's installation instructions.

⚠ WARNING

If you secure a child in a rearward-facing child restraint system on the front-passenger seat and the PASSENGER AIR BAG ON indicator lamp is lit, the front-passenger front airbag can deploy in the event of an accident. The child could be struck by the airbag. This poses an increased risk of injury or even fatal injury.

Make sure that the front-passenger front airbag has been disabled. The PASSENGER AIR BAG OFF indicator lamp must be lit.

NEVER use a rearward-facing child restraint on a seat protected by an ACTIVE AIRBAG in front of it; DEATH or SERIOUS INJURY to the child can occur.

If the PASSENGER AIR BAG OFF indicator lamp remains off and/or the PASSENGER AIR BAG ON indicator lamp lights up, do not fit a rearward-facing child restraint system on the front passenger seat. Further information can be found under "Problems with the front passenger front airbag shutoff" (▷ page 189).

⚠ WARNING

If you secure a child in a forward-facing child restraint system on the front-passenger seat and you position the front-passenger seat too close to the dashboard, in the event of an accident, the child could:

- come into contact with the vehicle's interior if the PASSENGER AIR BAG OFF indicator lamp is lit, for example
- be struck by the airbag if the PASSENGER AIR BAG ON is lit up

This poses an increased risk of injury or even fatal injury.

Move the front-passenger seat as far back as possible. Always make sure that the shoulder belt strap is correctly routed from the vehicle belt outlet to the shoulder belt guide on the child restraint system. The shoulder belt strap must be routed forwards and downwards from the vehicle belt outlet. If necessary, adjust the vehicle belt outlet and the front-passenger seat accordingly. Always observe the information in this Owner's Manual on suitable positioning of the child restraint system in addition to the child restraint system manufacturer's installation instructions.



Symbol for a rearward-facing child restraint system

If you use a rearward-facing child restraint system on the front passenger seat, you must disable the front passenger front airbag.

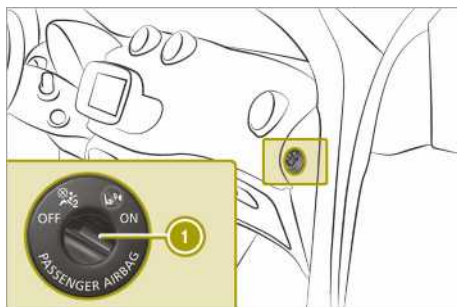

Airbag-off switch ①, to enable and disable the front passenger front airbag manually, is in the dashboard on the front passenger side.

- ▶ Press front passenger front airbag-off switch ① in beyond the point of resistance.
- ▶ **To disable the front passenger front airbag:** turn airbag-off switch ① anti-clockwise. The  PASSENGER AIR BAG OFF indicator lamp on the overhead control panel

lights up and remains lit up continuously when the ignition is switched on (▷ page 41).

- ▶ **To enable the front passenger front airbag:** turn airbag-off switch ① clockwise. The  PASSENGER AIR BAG ON indicator lamp on the overhead control panel lights up and remains lit up continuously when the ignition is switched on (▷ page 41).

The front passenger front airbag is generally enabled when the ignition is switched on, except when the front passenger front airbag has been disabled manually. When the front passenger front airbag is disabled, the  PASSENGER AIR BAG OFF indicator lamp on the overhead control panel (▷ page 41) lights up continuously when the ignition is switched on.

Attaching a child restraint system with the seat belt

Notes on the suitability of the seats for attaching belt-secured child restraint systems

Rear seats

Weight group	Left/right rear seat
Group 0: up to 10 kg	U, L
Group 0+: up to 13 kg	U, L
Group I: 9 to 18 kg	U, L
Group II: 15 to 25 kg	U, L
Group III: 22 to 36 kg	U, L
	U Suitable for child restraint systems in the "Universal" category in this weight category. L Suitable for semi-universal child restraint systems in accordance with the table in "Recommended child restraint systems", or if the vehicle and the seat are listed in the child restraint system manufacturer's vehicle model list.

Front passenger seat – notes

Notes on child restraint systems on the front passenger seat

- If circumstances require you to fit a child restraint system to the front passenger seat, be sure to observe the notes on child restraint systems on the front passenger seat (▷ page 55).

Observe the specific notes on rearward-facing and forward-facing child restraint systems. If the front passenger seat is occupied, make sure that the status of the front passenger front airbag is correct depending on the situation both before and during the journey.

>> Safety.

Weight group	Front passenger front airbag is enabled	Front passenger front airbag is disabled ¹
		1 The vehicle is equipped with a front passenger front airbag deactivation system. The PASSENGER AIR BAG OFF indicator lamp must be lit.
Group 0: up to 10 kg	X	U, L
Group 0+: up to 13 kg	X	U, L
Group I: 9 to 18 kg	UF, L	U, L
Group II: 15 to 25 kg	UF, L	U, L
Group III: 22 to 36 kg	U, L	U, L
	X Not suitable for an ISOFIX child restraint system in this weight category and/or size category. UF Suitable for forward-facing child restraint systems in the "Universal" category in this weight category.	U Suitable for child restraint systems in the "Universal" category in this weight category. L Suitable for semi-universal child restraint systems in accordance with the table in "Recommended child restraint systems", or if the vehicle and the seat are listed in the child restraint system manufacturer's vehicle model list.

Attaching a child restraint system with the seat belt to the rear seat

When fitting a belt-secured child restraint system, observe the following:

- ✓ Be sure to observe the installation and operating instructions provided by the manufacturer for the child restraint system being used.
 - ✓ When using a "Universal" or "Semi-Universal" category child restraint system, ensure that it is approved for the vehicle seat.
- Observe the notes under "Suitability of seats for securing belt-secured child restraint systems" (▷ page 53).
- ✓ **When using a category 0/0+ baby car seat and a category I, rearward-facing child restraint system on a rear seat:** adjust the front seat so that the seat does not touch the child restraint system.
 - ✓ The backrest of a forward-facing child restraint system must, as far as possible, rest flat against the backrest of the rear seat.
 - ✓ For certain child restraint systems in weight category II or III, there may be

restrictions on the maximum size setting, e.g. due to possible contact with the roof.

- ☑ The child restraint system must not be put under strain between the roof and the seat cushion and/or be fitted facing the wrong direction. If possible, adjust the seat cushion angle as appropriate.
- ☑ The child restraint system must not be put under strain by the head restraint. Adjust the head restraints as appropriate.
- ☑ Make sure that the child's feet do not touch the front seat. If necessary, move the front seat forwards slightly.

► Fit the child restraint system.

The base of the child restraint system must lie fully on the front passenger seat cushion.

- Always make sure that the shoulder belt strap is correctly routed from the seat belt outlet of the vehicle to the shoulder belt guide on the child restraint system. The shoulder belt strap must be routed forwards and downwards from the seat belt outlet.

Notes on rearward and forward facing child restraint systems on the front passenger seat

WARNING

If you secure a child in a rearward-facing child restraint system on the front-passenger seat and the PASSENGER AIR BAG OFF indicator lamp is off, the front-passenger front airbag can deploy in the event of an accident. The child could be struck by the airbag. This poses an increased risk of injury or even fatal injury.

Make sure that the front-passenger front airbag has been disabled. The PASSENGER AIR BAG OFF indicator lamp must be lit.

NEVER use a rearward-facing child restraint on a seat protected by an ACTIVE AIRBAG in front of it; DEATH or SERIOUS INJURY to the child can occur.

Observe the specific notes on rearward-facing and forward-facing child restraint systems.



Warning notice on the front passenger sun visor

PASSENGER AIR BAG OFF indicator lamp: always pay attention to the status of the front passenger front airbag.

- If circumstances require you to fit a child restraint system on the front passenger seat, be sure to observe the notes on disabling the front passenger front airbag.
- When using a rearward-facing child restraint system on the front passenger seat, the front passenger front airbag must always be deactivated. This is only the case if the PASSENGER AIR BAG OFF indicator lamp is lit continuously.
- If the PASSENGER AIR BAG OFF indicator lamp goes out, the front passenger front airbag is activated. The front passenger front airbag may deploy during an accident.

Attaching a child restraint system with the seat belt to the front passenger seat

When fitting a belt-secured child restraint system on the front passenger seat, always observe the following:

- ☑ Be sure to observe the installation and operating instructions provided by the manufacturer for the child restraint system being used.
- ☑ When using a "Universal" or "Semi-Universal" category child restraint system, ensure that it is approved for the vehicle seat.

Observe the notes under "Suitability of seats for securing belt-secured child restraint systems" (> page 53).

- ✔ The backrest of a forward-facing child restraint system must, as far as possible, rest flat against the backrest of the front passenger seat.
 - ✔ For certain child restraint systems in weight category II or III, there may be restrictions on the maximum size setting, e.g. due to possible contact with the roof.
 - ✔ The child restraint system must not be put under strain between the roof and the seat cushion and/or be fitted facing the wrong direction.
 - ✔ The child restraint system must not be put under strain by the head restraint.
 - ✔ Never place objects, such as cushions, under or behind the child restraint system.
- ▶ Set the front passenger seat as far back as possible.
 - ▶ Adjust the seat backrest to an almost vertical position.
 - ▶ Fit the child restraint system.
The entire base of the child restraint system must always rest on the seat cushion of the front passenger seat.
 - ▶ Always make sure that the shoulder belt strap is correctly routed from the seat belt outlet of the vehicle to the shoulder belt guide on the child restraint system.
The shoulder belt strap must be routed forwards and downwards from the seat belt outlet.
 - ▶ If necessary, adjust the seat belt outlet and the front passenger seat as appropriate.

Pets in the vehicle

WARNING

If you leave animals unsupervised or unsecured in the vehicle, they may press buttons or switches, for instance.

In this way, animals may:

- activate vehicle equipment and become trapped, for example
- switch systems on or off and thereby endanger other road users

Furthermore, unsecured animals may be flung around inside the vehicle in the event of an accident or abrupt steering or braking manoeuvre, and thereby injure vehicle occupants. There is a risk of accident and injury.

Never leave animals unattended in the vehicle.

Always secure animals properly when driving, for instance with a suitable pet carrier.

Driving safely

Driving safety system limitations

- ❗ Make sure you have suitable tyres, so that assistance systems and driving safety systems can work as effectively as possible.

If you fail to adapt your driving style or if you are inattentive, the driving safety systems can neither reduce the risk of accident nor override the laws of physics. Driving safety systems are merely aids designed to assist driving. You are responsible for the distance to the vehicle in front, for vehicle speed and for braking in good time. Always adapt your driving style to suit the prevailing road, weather and traffic conditions and maintain a safe distance from the vehicle in front. Drive carefully.

For safety reasons, smart recommends that you only use snow chains that have been specially approved for your vehicle by smart. Further information can be obtained at a smart centre or a qualified specialist workshop.

Braking with ABS (Anti-lock Braking System)

ABS regulates brake pressure in such a way that the wheels do not lock when you brake. This allows you to continue steering the vehicle when braking.

When you switch on the ignition, the  warning lamp in the instrument cluster lights up. It goes out after the engine is started.

ABS works from a speed of about 6 km/h, regardless of road-surface conditions. ABS intervenes in the case of slippery road surfaces, even when you only brake gently.

- ▶ **To brake while ABS intervenes:** continue to depress the brake pedal with force until the braking situation is over.
- ▶ **To make a full brake application:** depress the brake pedal with full force.

WARNING

If ABS is faulty, the wheels could lock when braking. The steerability and braking characteristics may be severely impaired. Additionally, further driving safety systems are deactivated. There is an increased danger of skidding and accidents.

Drive on carefully. Have ABS checked immediately at a qualified specialist workshop.

Using Active Brake Assist

Useful information

With the help of the radar sensor system, Active Brake Assist can calculate the distance of your vehicle to the vehicle travelling in front.

If for several seconds, the distance to the vehicle ahead is insufficient for the speed you are driving at, Active Brake Assist alerts the driver visually.

If a risk of collision is detected, Active Brake Assist alerts the driver both visually and acoustically. In addition, Active Brake Assist prepares the vehicle for a possible emergency braking manoeuvre.

In particularly critical situations Active Brake Assist may brake autonomously. In this case, Active Brake Assist continues to alert the driver both visually and acoustically.

Please note

WARNING

Active Brake Assist cannot always clearly identify objects and complex traffic situations.

In these cases, Active Brake Assist may:

- warn or brake for no reason
- not issue a warning
- not brake

There is a risk of an accident.

Always pay careful attention to the traffic situation and do not rely on Active Brake Assist alone. Be prepared to brake or manoeuvre if necessary.

WARNING

Active Brake Assist does not react:

- to persons, bicycles, motorcycles or animals
- to approaching vehicles
- to cross traffic
- on bends

As a result, Active Brake Assist cannot intervene in all critical situations. There is a risk of an accident.

Always pay careful attention to the traffic situation and be prepared to brake.

WARNING

Severe jolting, for example in the case of a collision, may cause the radar sensors to be misaligned. The function of Active Brake Assist is then impaired.

There is a risk of an accident.

Deactivate Active Brake Assist. Have Active Brake Assist checked at a qualified specialist workshop.

The following requirements must also be fulfilled:

- the selector lever is in position .
- the parking brake is released.
- the driving speed is within the suitable speed range.

Detection can be restricted under the following conditions:

- the vehicle is new or service work has been carried out on the system. In this case,

observe the information on running-in the vehicle.

- the radio sensors are dirty or covered (▷ page 166)
- in heavy rain or snow
- there is interference from other radar sources, e.g. in multi-storey car parks
- the vehicle travelling in front is narrow, e.g. a motorcycle
- the vehicle travelling in front is travelling on a different line



Autonomous braking can be cancelled by briefly depressing the accelerator pedal.

If the brake lamps are inoperative, deactivate Active Brake Assist.

- ❗ Observe the notes on "Limitations of the driving safety systems" (▷ page 56).

Distance warning and forward collision warning with autonomous braking function

Method of operation

If the distance maintained to the vehicle ahead is insufficient for the speed you are driving at, the  warning lamp lights up. If Active Brake Assist detects a risk of collision while driving, the  warning lamp lights up and a warning tone sounds. If the driver depresses the brake pedal fast, the braking pressure may be increased to a full brake application.

The autonomous braking function may intervene if the driver does not react to the forward collision warning.

When driving at speeds of more than 30 km/h, the forward collision warning may issue a warning in the following situations:

Situation	Speed you are travelling
Vehicles travelling ahead	30 - 140 km/h
Vehicles coming to a standstill	30 - 140 km/h
Stationary vehicles	30 - 80 km/h
Other objects or crossing vehicles	No warning possible

When driving at speeds of more than 30 km/h, the autonomous braking function may intervene in the following situations:

Situation	Speed you are travelling
Vehicles travelling ahead	30 - 140 km/h
Vehicles coming to a standstill	30 - 140 km/h
Stationary vehicles	No intervention possible
Other objects or crossing vehicles	No intervention possible

Activating or deactivating Active Brake Assist

Active Brake Assist is automatically activated when you start the engine.

Monochrome display: activating/deactivating Active Brake Assist using the on-board computer (▷ page 109).

Colour display: activating/deactivating Active Brake Assist using the on-board computer (▷ page 110).

Adaptive brake lamps

The adaptive brake lights warn following traffic in an emergency situation:

If you brake the vehicle sharply from a speed of more than 50 km/h the brake lamps flash rapidly.

If the vehicle is sharply braked to a standstill at a speed of over 70 km/h, the hazard warning lamps are also switched on automatically. The hazard warning lamps switch off automatically if you subsequently drive faster than 10 km/h.

Driving with ESP®

If ESP® detects that the vehicle is deviating from the direction desired by the driver, one or more wheels are braked to stabilise the vehicle.

ESP® supports the driver when pulling away on wet or slippery roads. ESP® can also sta-

bilise the vehicle during braking. ESP® comprises ETS (Electronic Traction System) and Crosswind Assist.

ETS brakes the drive wheels individually if they spin. This enables you to pull away or accelerate on slippery surfaces, for example if the road surface is slippery on one side.

Strong crosswind gusts can impair the road-holding of your vehicle when driving straight ahead.

Crosswind Assist reduces these impairments. Crosswind assist is active at vehicle speeds above 70 km/h when driving straight ahead or cornering gently.

If ESP® intervenes, pull away carefully and adapt your driving style to the prevailing road and weather conditions.

If the  warning lamp goes out before beginning the journey, ESP® is active. If ESP® intervenes, the  warning lamp flashes in the instrument cluster.

WARNING

If ESP® is malfunctioning, ESP® is unable to stabilise the vehicle. In addition, other driving safety systems are switched off. This increases the risk of skidding and an accident.

Drive on carefully. Have ESP® checked at a qualified specialist workshop.

Information on EBD (Electronic Brake-force Distribution)

EBD monitors and controls the brake pressure on the rear wheels to improve driving stability while braking.

WARNING

If EBD is malfunctioning, the rear wheels can lock, e.g. under full braking. This increases the risk of skidding and an accident.

You should therefore adapt your driving style to the different handling characteristics. Have the brake system checked at a qualified specialist workshop.

Understanding functions of the key

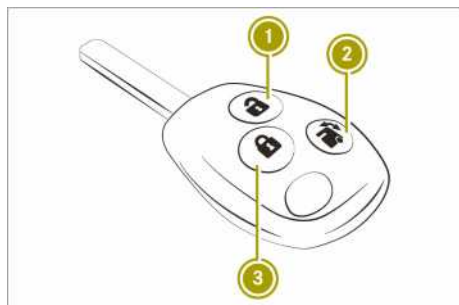

- ① Unlocks the vehicle
- ② Opens the tailgate (press and hold)
- ③ Locks the vehicle

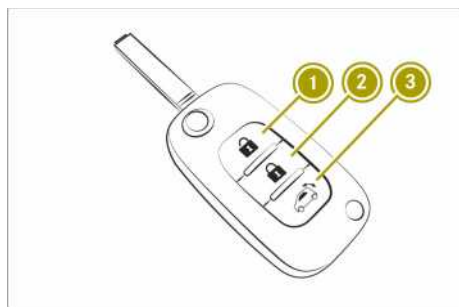

- ① Unlocks the vehicle
- ② Locks the vehicle
- ③ Opens the tailgate (press and hold)

▶ **To unlock centrally:** press the button. The turn signals flash once.

i After unlocking, open the vehicle within approximately two minutes to prevent it from locking itself and priming the anti-theft alarm system again.

▶ **To unlock and open the tailgate:** press and hold the or button.

▶ **To lock centrally:** press the button. The turn signals flash twice.

▶ **To activate the double-lock function (for United Kingdom only):** press the button twice. The turn signals flash twice slowly and three times quickly.

Opening the door

- ▶ Press the button on the key.
- ▶ Open the door.

i After unlocking, open the vehicle within approximately two minutes to prevent it from locking itself and priming the anti-theft alarm system again.

Correct driver's seat position

WARNING

You could lose control of the vehicle while driving if you:

- adjust the driver's seat, steering wheel or mirror
- fasten the seat belt.

There is a risk of an accident.

Adjust the driver's seat, steering wheel or mirror and fasten the seat belt before starting the engine.



Observe the following rules on the correct driver's seat position:

- the driver must be as far away from the driver's airbag as possible (▷ page 40).
- the driver must be wearing seat belt ③ properly.
- the driver must be able to depress the pedals properly.
- the driver must be able to move their legs freely.
- the driver must be able to reach steering wheel ① with their arms slightly bent.

- the driver must be able to see all the displays in the instrument cluster clearly.
- move seat backrest ② to an almost vertical position.
- sit in a normal upright position.
- the seat belt must fit snugly across your body.
- the seat belt must be routed across the middle of your shoulder.
- the seat belt must be routed in your pelvic area across the hip joints.
- adjust the rear-view and exterior mirrors so that the driver has a good view of the road and traffic.

Adjusting the seats

Please note

WARNING

If children adjust the seats, they could become trapped, especially if they are unattended. There is a risk of injury. When leaving the vehicle, always take the key with you and lock the vehicle. Never leave children unattended in the vehicle.

WARNING

If the driver's seat is not correctly engaged, it could unexpectedly move while driving. This could cause you to lose control of the vehicle. There is a risk of an accident.

Always ensure that the driver's seat is engaged before starting the vehicle.

WARNING

When adjusting a seat, you or another vehicle occupant could become trapped by the guide rail of the seat, for instance. There is a risk of injury.

Make sure that no one has any part of their body within the sweep of the seat when adjusting it.

WARNING

The seat belt does not offer the intended level of protection if you have not moved the backrest to an almost vertical position. When braking or in the event of an accident, you could slide underneath the seat belt and sustain abdomen or neck injuries, for example. This poses an increased risk of injury or even fatal injury.

Adjust the seat properly before beginning your journey. Always ensure that the backrest is in an almost vertical position and that the shoulder section of your seat-belt is routed across the centre of your shoulder.

WARNING

The steering wheel may move unexpectedly if you adjust it while driving. This could cause you to lose control of the vehicle. There is a risk of an accident.

Make sure that the steering wheel is locked before driving off. Never unlock the steering wheel when the vehicle is in motion.

WARNING

You could lose control of the vehicle while driving if you:

- adjust the driver's seat, steering wheel or mirror
- fasten the seat belt.

There is a risk of an accident.

Adjust the driver's seat, steering wheel or mirror and fasten the seat belt before starting the engine.

- ! Make sure that there are no objects in the footwell under or behind the seats when moving the seats back. There is a risk that the seats and/or the objects could be damaged.

Observe the safety notes on "Airbags" (▷ page 40) and "Children in the vehicle" (▷ page 42).

Adjusting the seat fore-and-aft position

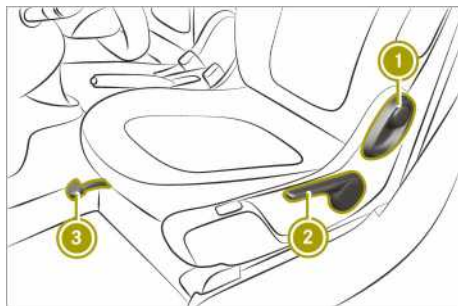

Seat with a lever

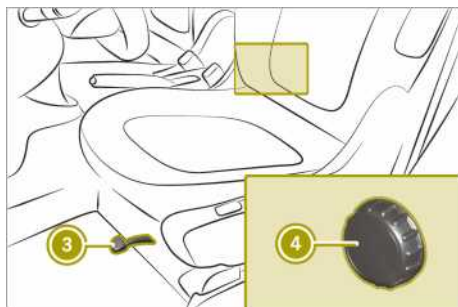

Seat with a handwheel

To adjust the seat fore-and-aft position, the seat belt must not be fastened.

- ▶ Lift lever ③.
- ▶ Slide the seat forwards or backwards. The seat engages audibly.

Adjusting the seat height (seat with a lever only)

- ▶ Pull handle ② up or push it down several times.

Adjusting the seat backrest (seat with a lever)

- ▶ Pull lever ① upwards.
- ▶ At the same time, move the backrest forwards or backwards.

Adjusting the seat backrest (seat with a handwheel)

- ▶ Turn handwheel ④ forwards or backwards.

Adjusting the steering wheel

⚠ WARNING

The steering wheel may move unexpectedly if you adjust it while driving. This could cause you to lose control of the vehicle. There is a risk of an accident.

Make sure that the steering wheel is locked before driving off. Never unlock the steering wheel when the vehicle is in motion.

⚠ WARNING

You could lose control of the vehicle while driving if you:

- adjust the driver's seat, steering wheel or mirror
- fasten the seat belt.

There is a risk of an accident.

Adjust the driver's seat, steering wheel or mirror and fasten the seat belt before starting the engine.

⚠ WARNING

Children could become trapped by the steering wheel if they adjust it. There is a risk of injury.

When leaving the vehicle, always take the key with you and lock the vehicle. Never leave children unattended in the vehicle.

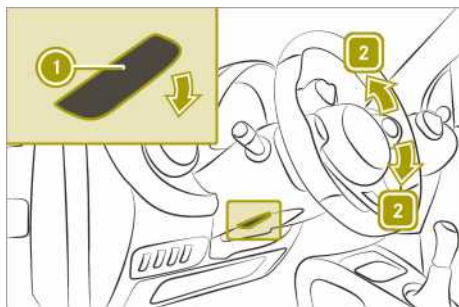

- ▶ Fold down lever ①.
- ▶ Set desired steering wheel height ②.
- ▶ Fold up lever ①.
- ▶ Check that the steering column is locked.

Adjusting the mirrors

Adjusting the interior mirror

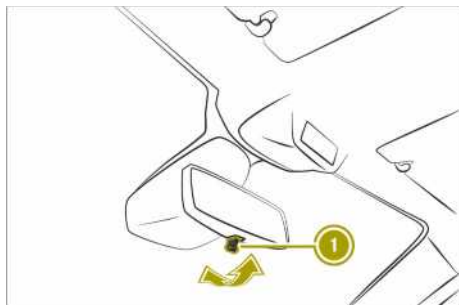

- ▶ Move the interior mirror up, down, left or right.

Manually setting the interior mirror to anti-dazzle mode

- ▶ Fold lever ① forwards.

Understanding automatic anti-dazzle mode of interior mirror

Please note

⚠ WARNING

Electrolyte may escape if the glass in an automatic anti-dazzle mirror breaks. The electrolyte is harmful and causes irritation. It must not come into contact with your skin, eyes, respiratory organs or clothing or be swallowed. There is a risk of injury.

If you come into contact with the electrolyte, observe the following:

- Rinse off the electrolyte from your skin immediately with water.
- Immediately rinse the electrolyte out of your eyes thoroughly with clean water.
- If the electrolyte is swallowed, immediately rinse your mouth out thoroughly. Do not induce vomiting.
- If electrolyte comes into contact with your skin or hair or is swallowed, seek medical attention immediately.
- Immediately change out of clothing which has come into contact with electrolyte.
- If an allergic reaction occurs, seek medical attention immediately.

Useful information

The interior mirror automatically goes into anti-dazzle mode if simultaneously:

- the ignition is switched on
- incident light from headlamps hits the sensor in the interior mirror

The interior mirror does not go into anti-dazzle mode if reverse gear is engaged or if the interior lighting is switched on.

Adjusting the exterior mirrors manually

⚠ WARNING

You could lose control of the vehicle while driving if you:

- adjust the driver's seat, steering wheel or mirror
- fasten the seat belt.

There is a risk of an accident.

Adjust the driver's seat, steering wheel or mirror and fasten the seat belt before starting the engine.

⚠ WARNING

The exterior mirrors reduce the size of the image. Objects visible in the mirrors are closer than they appear. You could misjudge the distance from road users driving behind you when changing lanes, for instance. There is a risk of an accident.

You should therefore always look over your shoulder to determine the actual distance from road users driving behind you.

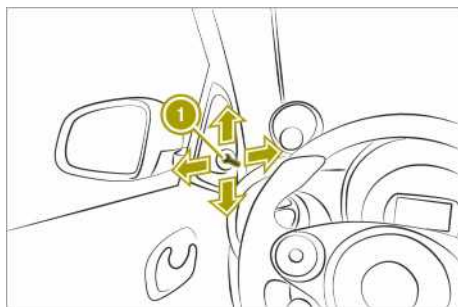

- ▶ Move lever ① up, down, left or right.

Adjusting the exterior mirrors electrically

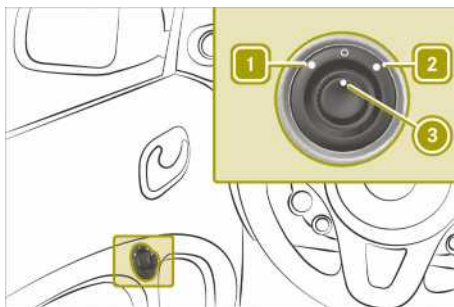

In order to adjust the exterior mirrors electrically, the ignition must be switched on.

- ▶ To select the left or right exterior mirror: turn control ③ left ① or right ②.
- ▶ To adjust the exterior mirrors: move control ③ up, down, left or right.

Adjusting head restraints in the rear compartment

Please note

⚠ WARNING

The head restraints cannot provide the intended protection unless they are fitted and adjusted correctly. There is an increased risk of injury to the head and neck in the event of an accident or sudden braking, for example.

Always drive with the head restraints fitted. Ensure that the centre of the head restraints support the back of each vehicle occupant's head at eye level before driving off.

Do not interchange the head restraints of the front and rear seats. Otherwise, you cannot adjust the height and angle of the head restraints to the correct position.

Raising the head restraints in the rear

- ▶ Pull the head restraint up until it engages.

Lowering the head restraints in the rear

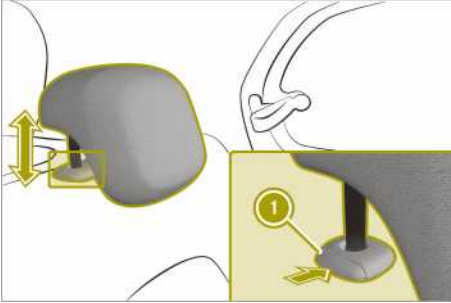

- ▶ Press release button ①.
- ▶ Push the head restraint down.

Using the armrest

Please note

- ❗ Do not lean on the armrest with full force or it could become damaged.

Starting the engine

Please note

WARNING

If children are left unsupervised in the vehicle, they can:

- open doors and endanger other persons or road users
- climb out and be injured by the traffic
- operate vehicle equipment and, for example, trap themselves.

Children could also set the vehicle in motion, for example by:

- releasing the parking brake
- shifting the automatic transmission out of park position **P**
- starting the engine.

There is a risk of an accident and injury.

When leaving the vehicle, always take the key with you and lock the vehicle. Never leave children unattended in the vehicle. Always keep the key out of reach of children.

WARNING

If you attach heavy or large objects to the key, the key could be unintentionally turned in the ignition lock. This could cause the engine to be switched off. There is a risk of an accident.

Do not attach any heavy or large objects to the key. Remove any bulky keyrings before inserting the key into the ignition lock.

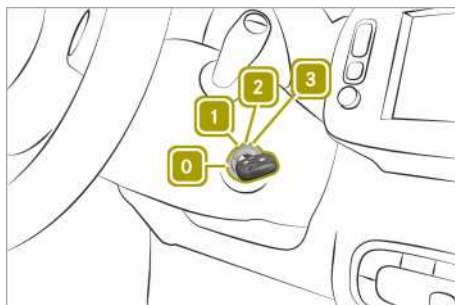

- 0** To insert the key into the ignition lock
- 1** To switch on the power supply
- 2** To switch on the ignition
- 3** To start the engine

Automatic transmission

- ▶ Turn the key to position **3**.
The **READY** indicator appears in the instrument cluster. A tone sounds.
- ▶ Shift out of transmission position **P** or **N**.

Pulling away

Please note

WARNING

Objects in the driver's footwell can impede pedal travel or block a pedal which is depressed. This jeopardises safe operation of the vehicle. There is a risk of an accident.

Stow all objects in the vehicle safely, so that they cannot reach the driver's footwell. Make sure the floormats and carpets are properly secured so that they cannot slip and obstruct the pedals. Do not lay several floormats or carpets on top of one another.

WARNING

Unsuitable footwear can hinder correct usage of the pedals, e.g.:

- shoes with thick soles
- shoes with high heels
- slippers

There is a risk of an accident.
Wear suitable footwear to ensure correct usage of the pedals.

⚠ WARNING

If you switch off the ignition while driving, safety-relevant functions are only available with limitations, or not at all. This could affect, for example, the power steering and the brake boosting effect. You will require considerably more effort to steer and brake. There is a risk of an accident. Do not switch off the ignition while driving.

Note the following when pulling away:

- Do not drive with the parking brake applied.
- Use caution when pulling away on slippery surfaces.
- Do not allow tyres to spin.
- Depress the brake pedal and keep it depressed.
- Press the release button on the selector lever.
- Shift the gear selector lever to position **D** or **R**.

Using the parking brake

Please note

⚠ WARNING

If the parking brake has not been fully released when driving, the parking brake can:

- overheat and cause a fire
- lose its hold function.

There is a risk of fire and an accident. Release the parking brake fully before driving off.

⚠ WARNING

If you must brake the vehicle with the parking brake, the braking distance is considerably longer and the wheels could

lock. This increases the risk of skidding and an accident.

Only use the parking brake to brake the vehicle when the service brake is faulty. Do not apply the parking brake too firmly. If the wheels lock, release the parking brake until the wheels begin turning again.

⚠ WARNING

If you leave children unattended in the vehicle, they may be able to set the vehicle in motion if, for example, they:

- release the parking brake
- shift the automatic transmission out of park position **P**
- start the engine

In addition, they may operate vehicle equipment and become trapped. There is a risk of an accident and injury.

When leaving the vehicle, always take the key with you and lock the vehicle. Never leave children unattended in the vehicle.

Applying the parking brake

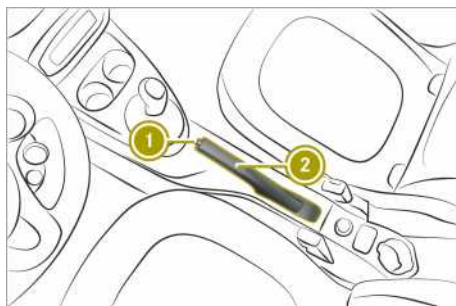

- ▶ Pull parking brake ② upwards.

The brake lights do not light up when you brake the vehicle with the parking brake.

Releasing the parking brake

- ▶ depress the brake pedal and keep it depressed.
- ▶ Press release button ① on parking brake ② and move the parking brake down to the stop.

Hill start assist

WARNING

After a while, hill start assist no longer holds the vehicle and it may roll away. There is a risk of an accident and injury. Therefore, quickly move your foot from the brake pedal to the accelerator pedal. Never leave the vehicle when it is held by hill start assist.

Hill start assist keeps the vehicle in place when driving uphill as soon as the brake pedal is released.

Hill start assist is only active in the following situations:

- when pulling away on an uphill slope
 - when the parking brake is released
 - the transmission is not in position **N**
 - ESP® is functioning correctly.
- ▶ Release the brake pedal.
The vehicle is then held for about one second.
- ▶ Pull away.

Automatic transmission

Please note

WARNING

When the engine is switched off, the automatic transmission shifts into neutral position **N**. The vehicle may roll away. There is a risk of an accident.

Always shift to parking position **P** before switching off the engine. Secure the parked vehicle against rolling away by applying the parking brake.

Transmission position display

- !** Only shift into transmission positions **P**, **R** or **N** when the vehicle is stationary. Otherwise, you may damage the transmission.

The following transmission positions are available:

- **P** Park position
Position **P** should not be used to brake the vehicle when parking. To secure the vehicle, apply the parking brake in addition to shifting to transmission position **P**.
- **R** Reverse gear
- **N** Neutral
No power is transmitted from the engine to the drive wheels.
- **D** Drive

Changing the transmission position

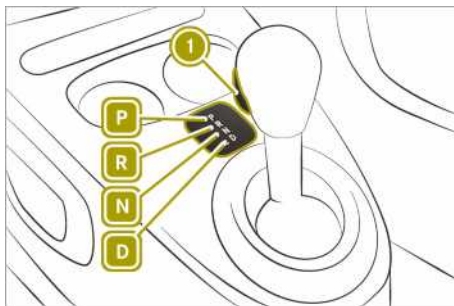

- P** Park position with parking lock
- R** Reverse gear
- N** Neutral
- D** Drive

The ignition must be switched on in order to shift the transmission to positions **P**, **N** or **R**. To shift the transmission from position **P**, you must also depress the brake pedal.

- ▶ Press release knob ①.
- ▶ Shift the selector lever to the desired transmission position.

Maximum acceleration (kickdown)

To reach maximum acceleration, use kickdown:

- ▶ Depress the accelerator pedal beyond the pressure point.
- ▶ Ease off the accelerator pedal once the desired speed is reached.

Using the turn signals

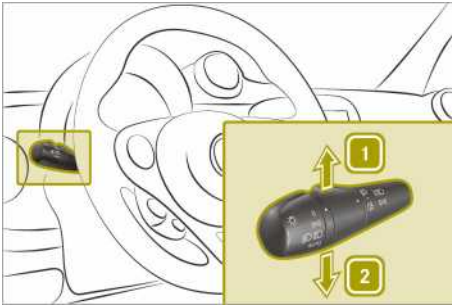

The ignition must be switched on in order to use the turn signals.

- ▶ To indicate: press the combination switch in the direction of arrow 1 (right) or 2 (left) past the point of resistance.
- ▶ To indicate briefly: press the combination switch briefly to the point of resistance. The turn signal flashes three times.

Acoustic presence indicator

Useful information

Vehicles with an electric motor generate much less driving noise than vehicles with internal combustion engines. As a result, the vehicle may not be heard by other road users in certain situations.



In order to allow your vehicle to be heard when it is moving at slow speeds, a sound generator installed in the vehicle produces a specific noise at speeds between 0 and 30 km/h. This function is called the acoustic presence indicator. This helps other road users, particularly pedestrians and cyclists, to hear your vehicle better. The acoustic presence indicator can also be heard in the vehicle interior.

The volume of the acoustic presence indicator depends on the engine speed. The faster you accelerate, the louder the sound is. At speeds of over 30 km/h, the sound is switched off. Above this speed, the driving noise naturally created by the vehicle is typically sufficient for the vehicle to be heard in good time by other road users.

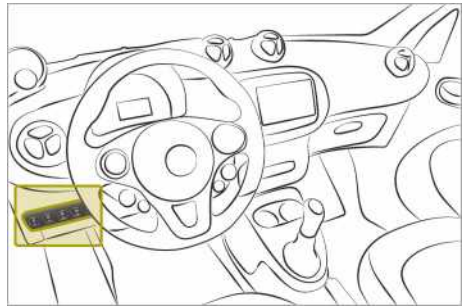
Deactivating/activating the acoustic presence indicator



The acoustic presence indicator is automatically activated each time the ignition is started.

- ▶ Press the  switch. If the acoustic presence indicator is deactivated, the LED on the  switch lights up.

Radar-based recuperation

Only for instrument cluster with colour display:

The "Radar-based recuperation" function adapts the vehicle's rate of recuperation to current traffic conditions. It activates itself automatically as soon as the accelerator pedal is released. There are five levels up to the maximum value for optimum recuperation and distance to the vehicle ahead. The maximum value can vary depending on the charge status of the battery and the battery temperature.

Radar sensors measure the distance to and the speed of a vehicle ahead. The shorter the distance to the vehicle ahead, the greater the recuperation. When recuperation is high, the brake lamps also light up. The current level of recuperation is not shown in the power display (> page 71).



Radar-based recuperation is not active in the following cases:

- the radar sensor system is malfunctioning
- the connection to the radar is interrupted
- Active Brake Assist is deactivated
- ECO mode is switched on

- the vehicle speed is too low
- the transmission is in position **R** or **N**

Radar-based recuperation is switched off when ECO mode is activated.

On-board computer with colour display: the  symbol in the display indicates the status of radar-based recuperation:

-  lights up white: switched on, not active
-  lights up green: switched on, active
-  is not displayed: Active Brake Assist is deactivated or the radar sensor is malfunctioning

On-board computer with colour display: radar-based recuperation is switched on and off in the on-board computer (▷ page 110).

Observe the notes on safe driving (▷ page 56).

Driving economically

Notes on economical driving

In order to save energy, a part of the kinetic energy is recuperated and stored in the high-voltage battery. When the driver releases the accelerator pedal, the vehicle decelerates.

In the following cases, the vehicle does not decelerate, or only decelerates to a limited extent, when the accelerator pedal is released:

- the gear lever is in position **D** and the vehicle is rolling backwards
- the gear lever is in position **R** and the vehicle is rolling forwards

On steep slopes, the vehicle may not be held at all or only be held to a limited degree.

In the following cases recuperation is restricted:

- the high-voltage battery is full or too cold
- the power electronics or engine has overheated

Recommendations for driving economically:

- accelerate moderately
- observe the power availability display (▷ page 71)
- drive with care

- use the air conditioning and the electrical consumers sparingly
- have maintenance work carried out at the specified service intervals

You can use ECO mode in order to save more energy.

ECO mode has the following characteristics:

- reduced torque and significantly reduced power. This supports a particularly efficient, steady driving style. The speed is reduced to approx. 110 km/h.
- the performance of the air-conditioning and heating systems is reduced.
- the maximum available recuperation is activated.
- the vehicle accelerates more slowly.
- the "radar-based recuperation" function is switched off.

To increase acceleration when in ECO mode, depress the accelerator pedal beyond the pressure point.

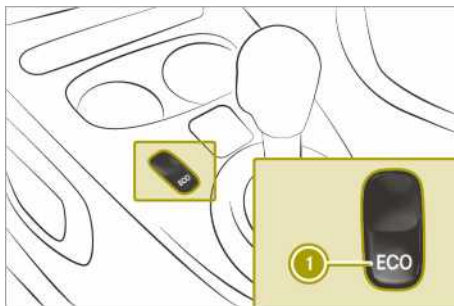

Switching ECO mode on and off

- Press button ①.

If the energy-saving function is activated, the **ECO** display is shown in the on-board computer.

The energy-saving function is switched off when the ignition is restarted.

Power and charge level display

Useful information

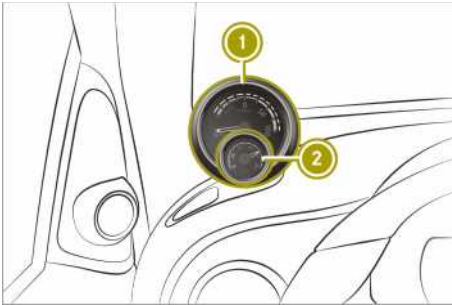

- ① Power display
- ② Charge level display

Power display ① and charge level display ② can be adjusted to the left or right. The charge level display lights up when the vehicle is unlocked.

Power display

! Do not hang any objects on the power display.

This could cause the dashboard clock to be torn out of its anchorage point and be severely damaged.

Power display ① contains two areas:

- Area to the right of 0
The current power that the high-voltage battery provides is shown here. 100% corresponds to the peak performance of the high-voltage battery.
- Area to the left of 0
The vehicle's level of recuperation in over-run mode and when braking is shown here.

The LED ring in power display ① shows the power output available.

If the needle for power display ① is in the "OFF" position, the vehicle is not ready to drive because:

- the ignition is switched off
- the gear lever has not been moved to position **N** or **P** to start the drive system
- the charging cable is still connected to the vehicle socket

- there is insufficient power available from the high-voltage battery
- there is a malfunction in the vehicle's high-voltage electrical system

If the drive system has been started, the needle of power display ① is in position "0". The **READY** indicator appears in the instrument cluster. A tone sounds. The vehicle is ready for driving.

Charge level display

! Do not hang any objects on the charge level gauge.

This could cause the charge level gauge to be torn out of its anchorage point and be damaged.

Charge level display ② displays the charge status of the high-voltage battery as a percentage.

The high-voltage battery has reached the reserve level in the following cases:

- the **Battery Reserve Level** message appears in the display
- charge level display ② is in the red area

i Charge the high-voltage battery when the charge falls below 20%.

Understanding the eco score display in the on-board computer

Useful information

The eco score display provides information on how to drive economically.

A higher percentage indicates a more economical driving style.

The percentage of the eco score display is only calculated after a short distance. If the ignition remains switched off for longer than four hours, the eco score display will be reset.

Monochrome display

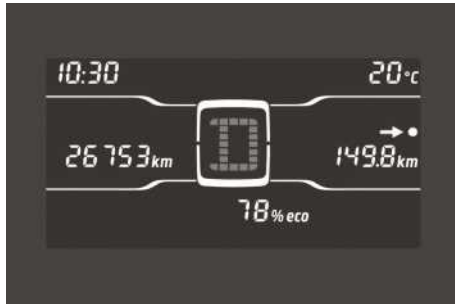

The percentage of the eco score display increases when you:

- accelerate with moderation
- avoid unnecessary acceleration and deceleration

Colour display



The percentage in the eco score display is calculated using the following categories:

- **Speed:** the value increases when driving at low speeds.
- **Anticipation:** the value increases when unnecessary acceleration and deceleration is avoided.

Using the eco score display in the smart Media-System

Calling up the eco score menu

- ▶ Select **Vehicle** > **eco score**.

Evaluating the current trip

- ▶ Select **Current trip**.
Evaluation information and values are calculated.

The following rating information and values appear:

- Bar graphs for **accelerate**, **anticipatory** and **shift**
- Bar graphs for **Speed** and **Anticipation**
- Distance covered
- Total eco score as a percentage

Saving the current trip

- ▶ Select **Current trip** > **Save**.
- ▶ Select the category under which you want to save the trip.
The values for the current trip will be added to the category selected and the current trip will be reset. In the instrument cluster, the trip computer values will be returned to "From reset".

The values for the current trip will be added to the category selected and the current trip will be reset. In the instrument cluster, the values for the "From start" trip computer and eco score display will be reset.

Comparing the current trip with the saved trips from a category



- ① Last trip saved in this category
 - ② Average value for the category
 - ③ Best trip in the category
- ▶ Select **Current trip** > **+** > **Compare**.
 - ▶ Select a category.
A comparison of the values for the current trip with the values of the selected category appears.
 - ▶ Select the comparison value ①, ② or ③.
The current trip is compared to the respective comparison value from the category.

Resetting the current trip data

- ▶ Select **Current trip > Reset**.
- ▶ Select **Yes**.
In the instrument cluster, the trip computer values will be returned to "From reset".
In the instrument cluster, the values for the "From start" trip computer and eco score display will be reset.

Activating/deactivating eco score after a trip

- ▶ To activate: select **Current trip > [+] > Show eco score after trip**.
- ▶ To deactivate: select **Current trip > [+] > Hide eco score after trip**.

Displaying eco score for saved trips in a category

- ▶ Select **Vehicle > eco score > My preferred trips**.
- ▶ Select a category.
eco score displays the comparison values.
eco score contains the following comparison values for each category:
 - Summary
 - Last value
 - Average value
 - Best value
 For the category **Last trip saved** you can choose from various types of evaluations.
Types of evaluations:
 - Summary
 - Detailed report

Renaming a category

- At least one trip must be stored in the respective category.
- ▶ Select **Vehicle > eco score > My preferred trips > [+] > Rename this category**.

Resetting the eco score of a category

At least one trip must be stored in the respective category.

- ▶ Select **Vehicle > eco score > My preferred trips > [+] > Reset this category**.

Braking correctly

Please note

WARNING

The braking system can overheat if you leave your foot on the brake pedal while driving. This increases the braking distance and could even cause the braking system to fail. There is a risk of an accident.

Never use the brake pedal as a footrest. Do not simultaneously depress both the brake pedal and the accelerator pedal while driving.

The vehicle decelerates as soon as you release the accelerator pedal. This aids recuperation as the motor is used as a generator and charges the high-voltage battery.

Braking on steep downhill gradients

Observe the following rules when driving on downhill gradients:

- do not move the selector lever to position **[N]**
- if recuperation is restricted, also brake at intervals

Braking on wet road surfaces

There may be a delayed brake response when driving on wet roads, after driving through a car wash or after driving through deep water.

- ▶ Maintain a greater distance to the vehicle in front.
- ▶ Brake more firmly.

Braking on salt-treated roads

When driving on salt-treated roads, a layer of salt may form on the brake discs and pads.

This increases the vehicle's braking distance.

- ▶ In order to prevent any salt build-up, apply the brakes occasionally while paying attention to the traffic conditions.
- ▶ Brake carefully at the end of the journey and when starting the next journey.
- ▶ Maintain a greater distance to the vehicle in front.

Driving on wet roads

Aquaplaning

Depending on driving style and tyre tread depths, aquaplaning can occur on the road. Adapt your driving style as follows:

- ▶ Reduce the speed.
- ▶ Brake carefully.
- ▶ Avoid sudden steering movements.
- ▶ Avoid tyre ruts.

Fording

! Bear in mind that vehicles travelling in front or in the opposite direction create waves. This may cause the maximum permissible water depth to be exceeded.

These notes must be observed under all circumstances. You could otherwise damage the engine, the electronics or the transmission.

Observe the following when driving through standing water:

- ▶ Do not drive through water that is higher than the lower edge of the vehicle body.
- ▶ Drive at walking pace.

Winter driving

- ▶ Before the start of winter, have the vehicle checked at a qualified specialist workshop.
- ▶ Use winter tyres and, if applicable, snow chains.

- ▶ Drive carefully and avoid sudden acceleration, turning and braking on slippery road surfaces.
- ▶ Do not use cruise control.
- ▶ If the vehicle skids, take corrective steering actions to counteract the movement.
- ▶ If the vehicle skids, shift the transmission to position **N**.
- ▶ Do not use the outside temperature display as a way to determine if conditions are icy.
- ▶ Observe the road surface.

Lane Keeping Assist

Please note

WARNING

Lane Keeping Assist cannot always clearly detect lane markings.

In such cases, Lane Keeping Assist can:

- issue an unnecessary warning
- not issue a warning

There is a risk of an accident.

Always pay particular attention to the traffic situation and keep within the lane, especially if Lane Keeping Assist alerts you.

WARNING

The Lane Keeping Assist warning does not return the vehicle to the original lane. There is a risk of an accident.

Always steer, apply the brakes or accelerate the vehicle yourself, especially if Lane Keeping Assist alerts you.

Lane Keeping Assist issues an acoustic and visual warning when a vehicle unintentionally leaves the lane.

Lane Keeping Assist uses a camera which is located on the windscreen behind the rear-view mirror.

Lane Keeping Assist does not keep your vehicle in its lane. The driver is responsible for driving the vehicle in a safe manner and staying within the lane.



Lane Keeping Assist could be impaired or fail to respond under the following conditions:



- poor visibility
- strong glaring light
- dirty windscreen in the camera area
- unclear or broken lane markings
- very narrow and winding roads
- highly variable shade conditions on the road

When the turn signal is set, warnings are suppressed for a certain period of time.



No warning is given in the following situations:

- when crossing a lane marking quickly
- at speeds below 70 km/h

On-board computer with monochrome display: the  and  symbols in the display indicate the status of Lane Keeping Assist:



- : speed is below 70 km/h or lanes are not detected due to external causes. No warning is given when the vehicle leaves the lane.
- : speed is above 70 km/h and the system is able to detect lane markings. A warning is given if the vehicle unintentionally leaves the detected lane.

On-board computer with colour display: The  symbol in the display indicates the status of Lane Keeping Assist:

-  lights up white: speed is below 70 km/h or lanes are not detected due to external causes. No warning is given when the vehicle leaves the lane.
-  lights up green: speed is above 70 km/h and the system is able to detect lane markings. A warning is given if the vehicle unintentionally leaves the detected lane.

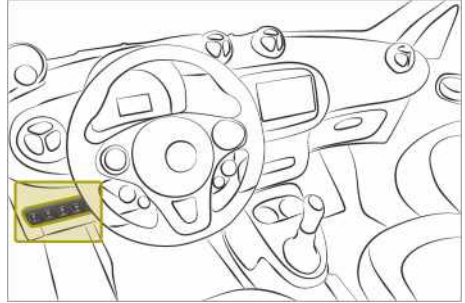
Activating and deactivating Lane Keeping Assist



- ▶ Press the  switch. When Lane Keeping Assist is deactivated, the LED on the  switch lights up.

On-board computer with colour display: the display also shows a message.

When the ignition is restarted, the last setting of Lane Keeping Assist is retained.

Cruise control and limiter

Please note

WARNING

If you call up the stored speed and this differs from your current speed, the vehicle will accelerate. If you do not know the stored speed, the vehicle can accelerate unexpectedly. There is a risk of an accident.

Before you call up the stored speed, pay attention to traffic conditions. If you do not know the stored speed, store the desired speed again.

Cruise control is used in order to drive at a constant speed for a prolonged period. The limiter helps to avoid exceeding a stored speed.

The driver is responsible for driving the vehicle in a safe manner, controlling the vehicle speed and braking in good time.

If there is a change of drivers, inform the new driver of the speed stored.

The two driver assist systems require the following:

- favourable weather and good visibility
- good road and traffic conditions

The cruise control and limiter systems do not brake automatically.

- reduce the vehicle speed by applying the brakes

Speed regulation is cancelled when the following occur:

- braking (including the parking brake)
- ESP® intervention

On downhill gradients or when accelerating briefly, cruise control may interrupt speed regulation. Afterwards, the set speed is applied again.

On downhill slopes, the limiter can exceed the set speed. In this case, the stored speed flashes in the display and a warning tone sounds.

Cruise control is ready for use at speeds above 30 km/h. With the limiter, speeds of 30 km/h and over can be set as the maximum speed.

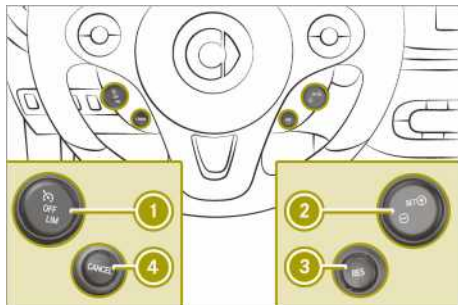

Cruise control and limiter cannot be activated at the same time.

Activating cruise control or the limiter





- ▶ Press top (cruise control) or bottom (limiter) of button ①.
The  (cruise control) or **LIM** (limiter) button appears in the instrument cluster display.

Storing the current speed

- ▶ Press  button ②.
Limiter: the stored speed appears next to the **LIM** symbol in the instrument cluster display.
Cruise control: the stored speed appears next to the  symbol in the instrument cluster display.

Adjusting the stored speed

- ▶ Press  button ② or  until the desired speed is reached.

Interrupting cruise control and the limiter

- ▶ Press  button ④.
The stored speed can be accessed again later.

The stored speed is deleted when the engine is switched off.

Calling up the stored speed

- ▶ Press  button ③.
- ▶ **Cruise control:** release the accelerator pedal.

Deactivating cruise control or the limiter

- ▶ Press button ① to the OFF centre position.
The  or **LIM** symbol in the instrument cluster display goes out. The stored speed is deleted.

The stored speed is deleted when the engine is switched off.

Charging the high-voltage battery

Please note



The vehicle's high voltage electrical system is under high voltage. If you modify

components in the vehicle's high-voltage electrical system or touch damaged components, you may be electrocuted. The components in the vehicle's high-voltage electrical system may be damaged in an accident, although the damage is not visible. There is a risk of fatal injury.

Do not touch any high-voltage components after an accident and never modify the vehicle's high-voltage electrical system. Have the vehicle towed away after an accident and the vehicle's high-voltage electrical system checked by a qualified specialist workshop.

 **WARNING**

In the event of a vehicle fire, the internal pressure of the high-voltage battery could exceed a critical value. In this case, flammable gas escapes through a vent valve in the vehicle's underbody. The gas could ignite. There is a risk of injury.

In cases of unusual smells developing, smoke or burn marks, stop the charging process immediately.

Leave the danger area immediately. Secure the danger area at a suitable distance. Contact a qualified specialist workshop.

 **WARNING**

If the housing of the high-voltage battery has been damaged, electrolyte and gases may leak out. These are poisonous and caustic. There is a risk of injury.

Avoid contact with the skin, eyes or clothing. Immediately rinse electrolyte splashes off with water and seek medical attention straight away.

 **DANGER**

The vehicle's high-voltage electrical system is under high voltage. If you carry out work on high-voltage components, you may suffer an electric shock. There is a risk of fatal injury.

To avoid such risks, observe the following:

- do not tamper with high-voltage components or the orange cables of the vehicle's high-voltage electrical system
- never touch the high-voltage components or the orange cables of the high-voltage electrical system in a vehicle which has been involved in an accident
- never touch any damaged components or the damaged orange cables of the vehicle's high-voltage electrical system
- do not remove the covers of the high-voltage electrical system components that are marked with a yellow warning sticker
- do not insert any objects which conduct electricity into the charging cable connector or the charging cable socket

 **DANGER**

The vehicle's high-voltage electrical system is under high voltage. If the charging process is not performed properly, it could cause a fire or an electric shock. There is a risk of fatal injury.

Do not perform the charging process in the following situations:

- at temperatures of over 50 °C and below -40 °C
- in storms
- if the charging cable is damaged, rusted or corroded
- if there is moisture on the charging cable connector or charging cable socket, or your hands are wet
- when cleaning the vehicle

To avoid hazardous situations, always handle the charging cable correctly before and after using it:

- before using the charging cable for the first time, remove the adhesive tape which holds the cable together
- unwind the charging cable fully before every charging process

- there must be no foreign objects in the charging cable connector or on the charging cable socket
- keep the charging cable out of the reach of children and animals. Always store the charging cable in a safe place, e.g. in the charging cable bag

The high-voltage battery must not be charged with a damaged charging cable. Therefore, always make sure that:

- you do not damage the charging cable, e.g. by driving over it, pulling too hard or as a result of heavy impacts
- the charging cable is not twisted, as otherwise the charging cable may overheat and the cable covering may be damaged
- the charging cable is not placed in water, fluids or snow

The charging cable must always be used in the correct manner. In order to ensure the charging cable is handled correctly, observe the following:

- do not make any changes or modifications to the charging cable
- only use the charging cable to charge the high-voltage battery
- do not pull out the charging cable connector or the charging cable socket during the charging process

For safety reasons, only use the charging cable which is supplied with the vehicle or has been approved by smart for this vehicle.

Useful information

Method of operation

The vehicle is equipped with a high-voltage battery for driving. The high-voltage battery stores the energy needed to operate the electric motor and releases it again.

The electric motor uses energy stored in the high-voltage battery for pulling away and accelerating.

In overrun mode, kinetic energy is converted into electrical energy by recuperation and stored in the high-voltage battery.

In addition to recuperation, the high-voltage battery can be charged as follows:

- with the suitable charging cable at a mains socket while the vehicle is stationary
- with the suitable charging cable at a wall-box while the vehicle is stationary
- with the suitable charging cable at a charging station while the vehicle is stationary

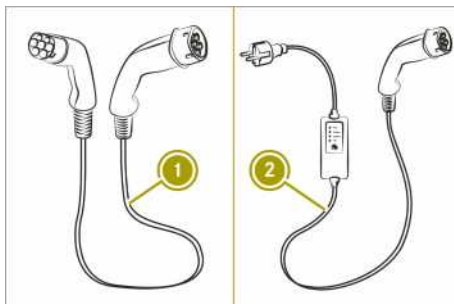

- ① Charging cable for charging at a charging station or wallbox
- ② Charging cable for charging at a mains socket

Charging cables may differ from the versions shown depending on the country.

The different versions of charging cables are distinguished by their charging cable connectors. Charging cables which are charged at a mains socket also have controls.

The options listed for charging a high-voltage battery are not available in all countries. The high-voltage battery can be charged at a charging station or wallbox in a nominal voltage range from 100 V to 400 V.

Vehicles with 22 kW on-board charger: the high-voltage battery can be charged in a nominal voltage range from 220 V to 400 V.

- ⓘ If possible only charge the high-voltage battery when the charge is below 80%. Charge the high-voltage battery at the latest when the charge falls below 20%.

Discharged high-voltage battery

The high-voltage electrical system switches off if the high-voltage battery is completely discharged. This protects the high-voltage battery from exhaustive discharge.

- i** Switching the ignition on and then off can reactivate the high-voltage electrical system temporarily. The vehicle can then be parked safely.

Do not leave the vehicle with a discharged or almost fully discharged high-voltage battery for longer than 14 days. You can check the charge status in the charge level display (▷ page 71).

Extreme outside temperatures

The efficiency of the high-voltage battery is temperature-dependent and is significantly reduced at low or high temperatures. In addition, the electrolytes used may freeze at very low temperatures.

The LED ring in the power output display shows the power output available (▷ page 71).

Energy consumption and range

The available energy in the high-voltage battery is basically reduced by the following factors:

- low outside temperatures
- operating the air-conditioning system or heating
- use of electrical consumers

Leaving the vehicle parked for an extended period at low outdoor temperatures without charging it can lead to the following:

- high-voltage battery output is significantly reduced
- charge times can be longer
- range can be significantly reduced

In extreme cases, it may not be possible to start the vehicle as a result. You should therefore always ensure that the high-voltage battery is fully charged or that the charging cable is connected when parking the vehicle for an extended period of time at low outside temperatures.

As the high-voltage battery ages, the capacity of the high-voltage battery will diminish over the battery's lifetime. This means that the maximum range and the maximum acceleration are reduced.

Battery care

Observe the following notes on battery care:

- avoid storing or transporting the vehicle in high temperatures over a long period (e.g. container transport).
- connect the vehicle to a power supply when parking it for an extended period of time.
- Temperatures below -25 °C for more than seven days can cause irreversible damage to the vehicle due to frost damage.

Terms of use

Observe the information on exceptions and limitations in the warranty documentation and in the Service Booklet.

Voltage surge protector

! Overvoltage in the mains supply can damage the vehicle. The vehicle is therefore equipped with a device which protects it from overvoltage in the mains supply. This device may be triggered during severe thunderstorms, for example, and may lead to the building's circuit breaker being tripped and an interruption in the power supply. These functions protect the vehicle. After the building's circuit breaker is switched on again, the charging process resumes automatically. Following an interruption in the power supply without the building's circuit breaker being tripped, it may take up to ten minutes for charging to resume automatically.

After the device has triggered, switch the building's fuse unit on again. Otherwise, the charging process will not resume.

Heat generated by the charging cable and charging cable connector

Charging cables and charging cable connectors may heat up during the charging process at a power socket.

In the following cases, the degree of heating is within the permissible limits:

- the mains supply and charging cable infrastructure are intact
- the instructions for handling the charging cable and control panel of the charging cable are observed

If heating up beyond the permissible limits occurs, have the mains supply infrastructure checked.

Disposing of a charging cable

Do not dispose of a charging cable with household rubbish, give it to a suitable recycling service. Abide by the potential legal requirements for recycling.

>> Driving.

Understanding the vehicle socket

Vehicle socket overview

DANGER

Connecting the charging cable to the mains supply via incorrectly installed mains sockets or by means of adapters, extension cables or similar could cause a fire or an electric shock. There is a risk of fatal injury.

To avoid hazardous situations, observe the following:

- Only connect the charging cable to the mains sockets:
 - which have been properly installed and
 - which have been inspected by a qualified electrician
- For safety reasons, only use the charging cables supplied with the vehicle, or charging cables which have been approved for use with this vehicle.
- Never use a damaged charging cable.
- Do **not** use:
 - extension cables
 - extension reels
 - multiple sockets

- Never use socket adapters to connect the charging cable to the mains socket. The only exception being if the adapter has been tested and approved by the manufacturer for charging the high-voltage battery of an electric vehicle.
- Observe the safety notes in the operating instructions for the socket adapter.

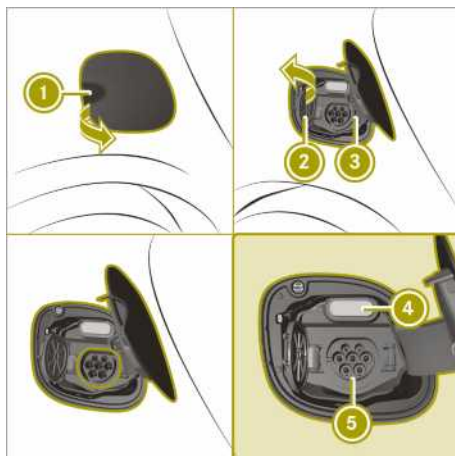

- ① Charge socket flap
- ② Socket cap
- ③ Locking mechanism
- ④ Indicator lamp
- ⑤ Vehicle socket

Indicator lamp on the vehicle socket

When the indicator lamp on the vehicle socket lights up, this means the following:

Indicator lamp

Flashes green slowly	High-voltage battery is charging.
Lights up green	High-voltage battery is fully charged.
Flashes orange slowly	Vehicle waiting for charging to start.

Indicator lamp

Flashes orange	Vehicle is paused from charging.
Flashes red quickly	A malfunction occurred during charging.

Charging the battery at a charging station or wall box**Charging stations without communication functionality**

Charging stations without communication functionality must be activated before charging, e.g. by using an RFID card. Observe the notes provided by the charging station operator.

Charging stations with communication capabilities (Plug&Charge)

The "Plug&Charge" function is not available in all countries.

A suitable electricity contract is required in order to use "Plug&Charge". To arrange this, contact the charging station operator.

If the vehicle is connected to a charging station with communication capabilities, information and technical parameters are exchanged so that the charging process can be started without additional activation. This function is called "Plug&Charge".

Due to the data transfer, it may take up to 30 seconds after the charging cable is connected before charging begins.

i International Standard ISO 15118 is used for the communication between the vehicle and the intelligent charging station.

Connecting a charging cable**⚠ DANGER**

Connecting the charging cable to the wallbox via an incorrectly installed wallbox or by means of adapters, extension cables or similar could cause a fire or an electric shock. There is a risk of fatal injury.

To avoid such risks, observe the following:

- Only connect the charging cable to a wallbox:
 - which has been properly installed and
 - has been inspected by a qualified electrician
- For safety reasons, only use charging cables which have been tested and approved for charging the high-voltage battery of an electric vehicle.
- Never use damaged charging cables.
- Do not connect the charging cable to an amplifier.
- Do not extend the charging cable.
- Never use an adapter.
- Observe the safety notes in the operating instructions for the wallbox.

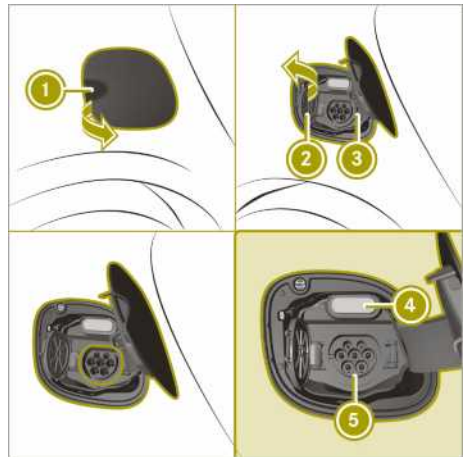

- ① Charge socket flap
- ② Socket cap
- ③ Locking mechanism
- ④ Indicator lamp
- ⑤ Vehicle socket

- **Wallbox without a pre-installed cable or charging station:** before using the charging cable for the first time, remove the adhesive tape, which holds the cable together.
- Fully unwind the charging cable before charging.

- ▶ Engage transmission position **P**.
- ▶ Turn the key to position **0** in the ignition lock and remove it.
- ▶ Open socket flap ① (> page 80).
- ▶ Release locking mechanism ③ on socket cap ②.
Socket cap ② opens.

- ▶ **Wallbox without a preinstalled cable:** insert the charging cable connector into the wallbox socket to the stop.
- ▶ Insert the charging cable connector into vehicle socket ⑤ to the stop.
The vehicle socket locks audibly.
The high-voltage battery is charged and indicator lamp ④ on the vehicle socket slowly flashes green.

- i** The high-voltage battery is fully charged when indicator lamp ④ on the vehicle socket lights up green.
- i** The vehicle must not be moved during charging. The gear lever cannot be shifted from position **P**.
- i** Depending on the temperature, the engine cooling system and battery cooling system may audibly switch on during the charging process.

Removing the charging cable

The charging cable may be removed when the charging process has completed or has been cancelled.

- !** Always disconnect the charging cable from the vehicle socket first. Disconnecting the charging cable from the stationary socket first could damage the charging cable connector.
- ▶ Press the  button on the key.
Indicator lamp ④ above vehicle socket ⑤ goes out.
Vehicle socket ⑤ unlocks audibly.
- ▶ Disconnect the charging cable within 60 seconds from vehicle socket ⑤. Otherwise, the vehicle will relock the vehicle socket.
The connector locking mechanism on the charging station is opened.
- ▶ Close socket cap ②.

- ▶ Close charge socket flap ①.
- ▶ **Wallbox without a pre-mounted cable or charging station:** if necessary, disconnect the charging cable from the wallbox and stow it in the charging cable bag (> page 85).

Understanding the charging cable for mains sockets

Useful information

- !** Only use the charging cable to charge the high-voltage battery. Do not use the charging cable for other purposes. It may otherwise be damaged.

Depending on the vehicle version, the vehicle is equipped with different charging cable versions. Charging cable versions differ in their controls.

- i** If you use the mains socket to charge the high-voltage battery, the charging time is longer and the electricity consumption is higher. If possible, charge the high-voltage battery at a wallbox or a charging station.

Only use a charging cable which is approved by smart for this vehicle.

Do not leave the charging cable control panel hanging loose from a mains socket. Otherwise, this could lead to a bad contact with the mains socket and to malfunctions when charging the vehicle.

Never lift or carry the control panel by the charging cable connector or the mains plug.

Only for charging cable version 1: before charging at a mains socket, check the maximum permissible charge current for the corresponding mains socket or building. The maximum value of the charge current is set to the country-specific setting for the supplied charging cable. When charging abroad, the maximum value may exceed that of the country you are in. Observe the regulations specific to the country you are in if charging abroad. Consult a qualified specialist workshop if you have questions about charge current settings or a malfunction.

Controls of charging cable version one

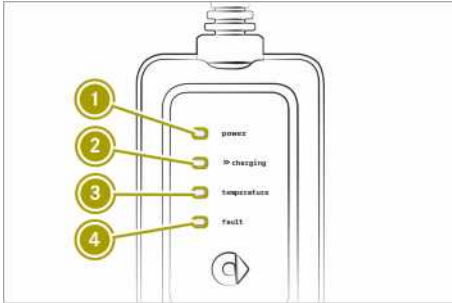

- ① Voltage indicator lamp
- ② Charging process indicator lamp
- ③ Indicator lamp temperature monitor
- ④ Electrical fuse and control system indicator lamp

The indicator lamps on the charging cable indicate the following:

Indicator lamp ①	
Lights up white	Voltage is switched on. The high-voltage battery can be charged.

Indicator lamp ②	
Flashes green	High-voltage battery is charging.

Indicator lamp ③	
Lights up red	With flashing green indicator lamp ②: the charge output is reduced due to over-temperature. Without flashing green indicator lamp ②: charging was terminated due to overtemperature on the charging cable.
Flashes red	Charging was terminated due to overtemperature on the mains socket.

Indicator lamp ④

Flashes red quickly	An internal malfunction has occurred. The high-voltage battery cannot be charged. The infrastructure has a malfunction. The high-voltage battery cannot be charged.
---------------------	--

If the control element detects a fault current or a malfunction, the charging process is interrupted. The charging process will be resumed automatically when the malfunction has been rectified.

Controls of charging cable version two

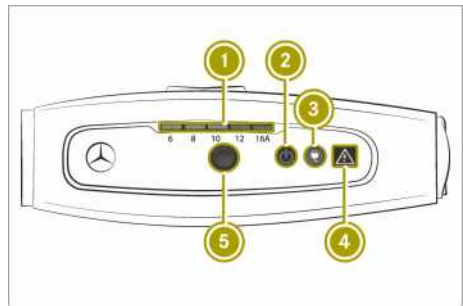

- ① Indicator lamp for charge current setting
- ② Voltage indicator lamp
- ③ Charging process indicator lamp
- ④ Electrical fuse and control system indicator lamp
- ⑤ Button for setting the charge current

The indicator lamps on the charging cable indicate the following:

Indicator lamp ①	
Lights up green	Value is set as the desired charging current.
Flashes orange	Depending on the mains socket, the value cannot be set as the desired charging current.

Indicator lamp ②

Lights up green	Voltage is switched on. The high-voltage battery can be charged.
-----------------	--

Indicator lamp ③

Lights up green	High-voltage battery is charging.
Flashes orange	Connection to vehicle has been made.

Indicator lamp ④

Lights up red	The current at the control panel is not correct. The high-voltage battery cannot be charged.
---------------	--

For transportation, wrap the charging cable around the control panel or secure it to the control panel housing.

Setting the charging current (only charging cable version two)

 **WARNING**

If the charge current draw via a mains socket is too high during the charging process, the external mains supply may overheat. There is a risk of fire.

Before charging, check the maximum permissible charge current available at the location. If necessary, contact a qualified specialist company for assistance.

Adjust your vehicle's settings, if necessary.

! If the charge current is too high, the fuse could be tripped or the external mains supply could overheat. Check if the external mains supply is equipped to handle the programmed charge current. If necessary, reduce the programmed charge current or use a different mains socket.

You can only limit the charging current for charging the high-voltage battery with

charging cable version 2. This may protect the mains supply from overloads.

The maximum setting value and the adjustment values may vary from country to country.

The preset default value is the minimum setting. This is the minimum charge current available from the mains supply.

If the charging cable is left connected to the mains socket, the currently selected values will be used for the next charging process. If the charging cable is removed from the mains socket, the values will be reset to the minimum setting for the next charging process.

- ▶ Check the maximum permissible charge current for the relevant mains socket.
- ▶ Insert the mains plug into the mains socket.
You have one minute to set the charge current.
- ▶ Press button ⑤ repeatedly until the indicator lamp in the desired setting lights up green.
The desired value has been set.

i After one minute, the charge current can only be set by restarting. To do so, remove the charging cable from the mains supply and reinsert it into the mains socket.

Charging the battery using a mains socket

Connecting a charging cable

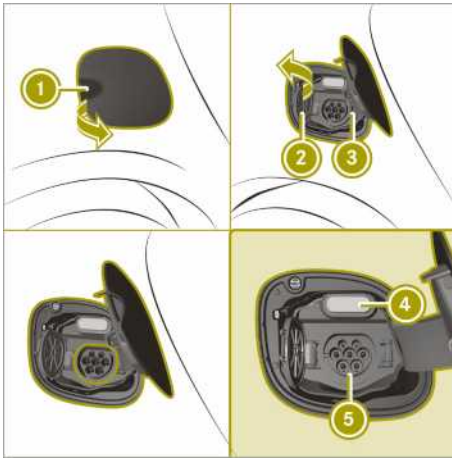

- ① Charge socket flap
- ② Socket cap
- ③ Locking mechanism
- ④ Indicator lamp
- ⑤ Vehicle socket

- ▶ Fully unwind the charging cable before charging.
- ▶ Engage transmission position **P**.
- ▶ Turn the key to position **0** in the ignition lock and remove it.
- ▶ Open socket flap ① (▷ page 80).
- ▶ Release locking mechanism ③ on socket cap ②. Socket cap ② opens.
- ▶ Insert the mains plug into the mains socket to the stop.
- ▶ **Only for charging cable version 2:** set the desired charge current.
- ▶ Insert the charging cable connector into vehicle socket ⑤ to the stop. The vehicle socket locks audibly. The high-voltage battery is charged and indicator lamp ④ on the vehicle socket slowly flashes green.

i The high-voltage battery is fully charged when indicator lamp ④ on the vehicle socket lights up green permanently.

i The vehicle must not be moved during charging. The gear lever cannot be shifted from position **P**.

i Depending on the temperature, the engine cooling system and battery cooling system may audibly switch on during the charging process.

i **Only for charging cable version 2:** if charging the vehicle's high-voltage battery is taking longer than usual, check the maximum charge current settings.

Removing the charging cable

! Always disconnect the charging cable from the vehicle socket first. Disconnecting the charging cable from the stationary socket first could damage the charging cable connector.

The charging cable can be removed when the high-voltage battery is completely charged or charging has to be interrupted.

- ▶ Press the  button on the key. Indicator lamp ④ above vehicle socket ⑤ goes out. Vehicle socket ⑤ unlocks audibly.
- ▶ Disconnect the charging cable within 60 seconds from vehicle socket ⑤. Otherwise, the vehicle will relock the vehicle socket.
- ▶ Close socket cap ②.
- ▶ Close charge socket flap ①.
- ▶ Remove the charging cable from the mains socket.
- ▶ Stow the charging cable safely in the charging cable bag (▷ page 85).

Storing the charging cable

! The charging cable must be stowed in the charging cable bag only to prevent it from being thrown around inside the vehicle.

- ▶ Stow the charging cable in the charging cable bag.

The charging cable bag is located in the boot (▷ page 153).

Switching on the lighting

Useful information

The driver must ensure that the light settings match the current weather, light and traffic conditions.

For reasons of safety, smart recommends that you drive with the daytime driving lights or dipped-beam headlamps switched on even during the daytime.

A warning tone sounds if the lights are still on when you leave the vehicle.

In some countries, operation of the headlamps varies due to legal requirements and self-imposed obligations.

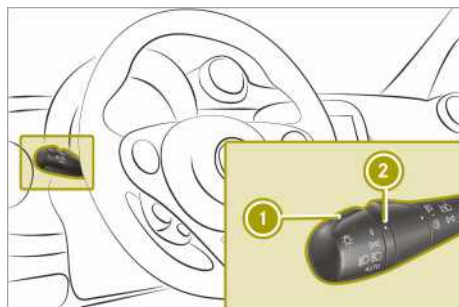

- ① Combination switch control
- ② Marking

Activating automatic headlamp mode

WARNING

When the light switch is set to **AUTO**, the dipped-beam headlamps may not be switched on automatically if there is fog, snow or other causes of poor visibility due to the weather conditions such as spray.

There is a risk of an accident.

In such situations, turn the light switch to .

While the engine is running, the light setting is selected automatically according to the brightness of the ambient light. **AUTO** controls the daytime driving lights, side lamps and dipped-beam headlamps. The automatic headlamp feature is only an aid. The driver is responsible for the vehicle's lighting at all times.

- ▶ Turn combination switch control ① to the **AUTO** position.

When one or more of the following occurs, the lights are switched off automatically:

- The engine is switched off.
- The driver's door is opened.
- The vehicle is locked.
- The main-beam headlamps are not switched on when the vehicle is stationary.

Switching on the dipped-beam headlamps

- ▶ Turn combination switch control ① to the  position.

The  indicator lamp lights up in the instrument cluster.

Switching the main-beam headlamps on or off

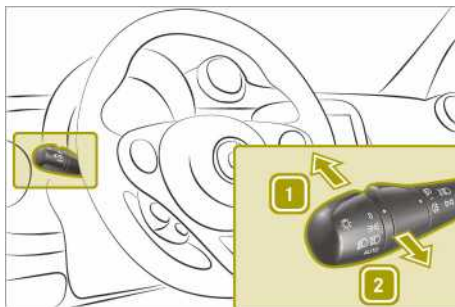

The engine must be running.

- ▶ Turn the combination switch control to the **AUTO** or  position.
- ▶ To switch on: press the combination switch in the direction of arrow 1.
- ▶ To switch off: move the combination switch back to its original position.

The  indicator lamp in the instrument cluster lights up when the main-beam headlamps are switched on.

Using the headlamp flasher

- ▶ Pull the combination switch in the direction of arrow [2].

Switching on the side lamps

- ▶ Turn combination switch control ① to the  position.

Switching the foglamps and rear fog-lamp on and off

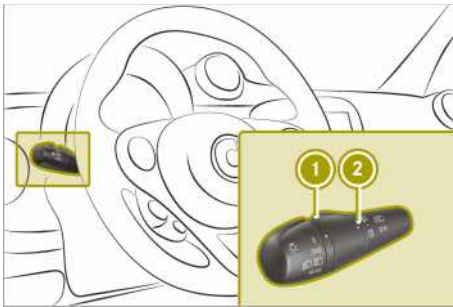

Only vehicles with front foglamps have the "Foglamps" function.



- ① Combination switch middle ring
- ② Marking

Switch on the ignition and either the side lamps or the dipped beam headlamps in order to switch on the fog lamps.

Start the engine and switch on either the side lamps or dipped beam headlamps in order to switch on the rear foglamp.

- ▶ To switch on or off manually: turn combination switch middle ring ① to the desired marking:
 -  Foglamps
 -  Rear foglamp

After releasing, the combination switch middle ring returns automatically to the neutral position.

The foglamps and rear foglamp also switch off automatically in the following situations:

- the lights are switched off.
- the engine is switched off and the control is in the **AUTO** position.

Using the cornering light function

Only vehicles with the LED & Sensor package are equipped with the cornering light function.

The cornering light function uses the front foglamps to improve the illumination of the road in the direction in which you are turning, enabling better visibility in tight bends, for example.

The following conditions must be fulfilled for the cornering light function to switch on automatically:

- the dipped-beam headlamps are switched on
- the vehicle is moving at less than 40 km/h
- the turn signal is switched on or the steering wheel is turned

Adjusting the lighting

Adjusting the headlamp range



The vehicle load can affect the headlamp range. This can impair visibility, and the headlamps can dazzle oncoming traffic.



The ignition must be switched on in order to set the headlamp range.

- ▶ Turn headlamp range adjuster ① to the position which corresponds to the load in your vehicle.

Positions for the vehicle load:

- : Driver's seat occupied or driver's seat and front-passenger seat occupied
- : All seats occupied

- [2]: All seats occupied and luggage compartment laden
- [3]: Driver's seat occupied and luggage compartment laden

Adjusting the dipped-beam headlamps to left-hand or right-hand traffic

The symmetrical dipped-beam headlamps are required when travelling in countries where vehicles are driven on the opposite side of the road to that in which the vehicle is registered. Unlike the asymmetrical dipped-beam headlamps, these headlamps do not dazzle oncoming traffic. Symmetrical dipped-beam headlamps provide less illumination to the edge of the carriageway.

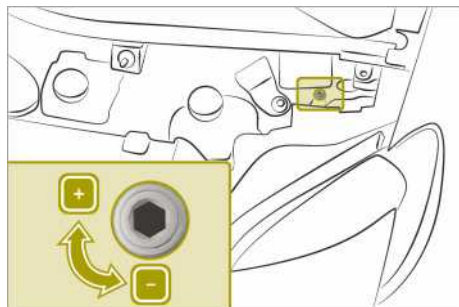

- ▶ Open the service cover.
- ▶ **For symmetrical dipped beam:** turn the screws of both headlamps as far as they will go to position **-**.
- ▶ **For asymmetrical dipped beam:** turn the screws of both headlamps as far as they will go to position **+**.
- ▶ Have the dipped-beam headlamp setting checked at a qualified specialist workshop.

Using the interior lighting

Switching the interior lighting on and off

The interior lights go on when you unlock the doors.

The interior lights switch off in the following situations:

- A door is opened and 15 minutes have passed.
- All doors are closed, the vehicle has been locked and 15 seconds have passed.
- All doors are closed, the vehicle has not been locked and 4 minutes have passed.
- The engine has been started.

The interior lighting can be activated when a door is open. After closing the doors, the interior lighting goes out.

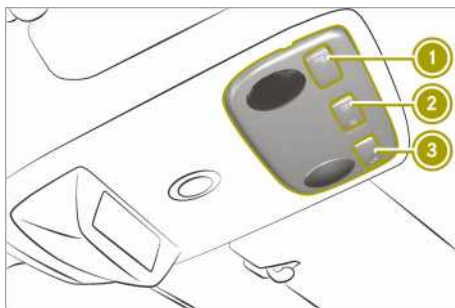

- ▶ Press switch ① to switch the left-hand reading lamp on and off.
- ▶ Move switch ② to the desired position:
 - Interior lighting switched on.
 - Interior lighting controlled automatically.
 - Interior lighting switched off.
- ▶ Press switch ③ to switch the right-hand reading lamp on and off.

Adjusting the ambient lighting (colour display)

On-board computer with colour display: the ambient lighting is set in the on-board computer (▷ page 110).

Using the windscreen wipers

Switching on the windscreen wipers

Please note

- ! Do not operate the windscreen wipers when the windscreen is dry, as this could

damage the wiper blades. Moreover, dust that has collected on the windscreen can scratch the glass if wiping takes place when the windscreen is dry.

If it is necessary to switch on the windscreen wipers in dry weather conditions, always operate them using washer fluid.

! Vehicles with a rain sensor: if the windscreen becomes dirty in dry weather conditions, the windscreen wipers may be activated inadvertently. This could damage the windscreen wiper blades or scratch the windscreen.



For this reason, you should always switch off the windscreen wipers in dry weather.

! Make sure that the windscreen wipers are free of ice. Otherwise the wiper motor may overheat.

Wiper blades are subject to wear and tear. smart recommends replacing the wiper blades twice a year. Worn or damaged wiper blades cause smearing on the windscreen. On vehicles with a rain sensor, malfunctions are then possible.

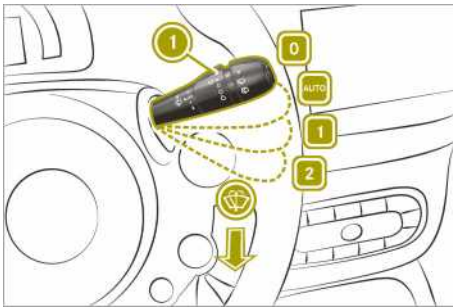
Switching continuous wipe on and off



- ① Control for wipe frequency
- 0 Continuous wipe, off
-  Automatic wipe
- 1 Continuous wipe, slow
- 2 Continuous wipe, fast
-  Wiper with washer fluid

The ignition must be switched on in order to operate the windscreen wipers.

- ▶ Press the combination switch down or up to the desired position.

Automatic wipe (vehicles with rain sensor)

The rain sensor is only an aid. The driver is responsible for ensuring good visibility at all times.

- ▶ Press the combination switch to the  position. In automatic wipe mode, the appropriate wiping frequency is set according to the intensity of the rain.
- ▶ Use control ① to set the wipe frequency.

Switching on intermittent wiping

- ▶ Press the combination switch to the  position.
- ▶ Use control ① to set the wipe frequency.



Wiping with washer fluid

- ▶ Pull the combination switch in the direction of arrow .

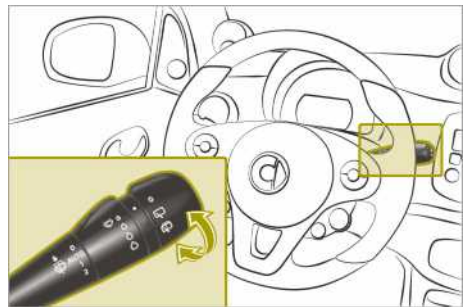
Switching the rear window wiper on/off



To operate the rear window wiper, the ignition must be switched on.

- ▶ Turn the outer control on the combination switch to the desired position:
 - 0 Rear window wiper off
 -  Rear window wiper on
 -  Wiper with washer fluid

Activating/deactivating the rear window wiper when reversing

You can switch the "Automatic rear window wiper when reversing" setting on or off in the

smart Media-System. The rear window wiper is automatically activated for a short while when the ignition is switched on, the window wipers are switched on and reverse gear is engaged.

- ▶ In the smart Media-System, select **Vehicle > Settings > Auto rear wipe with reverse gear**.
The selected setting is highlighted.
- ▶ Confirm the setting with **Done**.

Folding the sun visor to the side

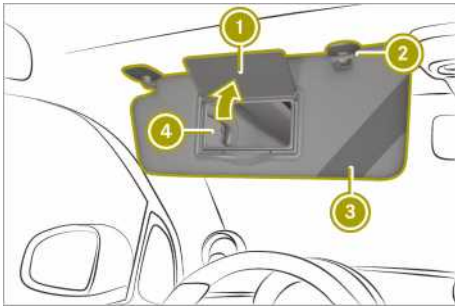

- ① Mirror cover
- ② Bracket
- ③ Retaining strap
- ④ Vanity mirror

- ▶ Fold the sun visor down.
- ▶ Pull the sun visor out of retainer ②.
- ▶ Fold the sun visor to one side

>> Ensuring good visibility.

Locking and unlocking the doors from the inside

Using the door handle to unlock the door

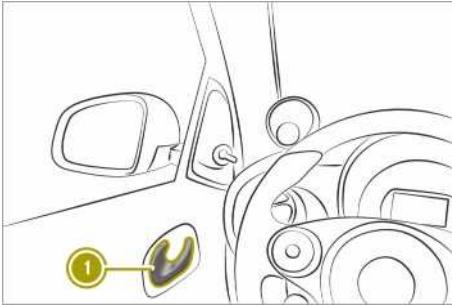

- ▶ Pull door handle ①.

If the vehicle has previously been locked with the key, opening a door from the inside will trigger the anti-theft alarm system. To disable the alarm, switch on the ignition.

Centrally locking and unlocking the vehicle from the inside

⚠ WARNING

If children are left unsupervised in the vehicle, they can:

- open doors and endanger other persons or road users
- climb out and be injured by the traffic
- operate vehicle equipment and, for example, trap themselves.

Children could also set the vehicle in motion, for example by:

- releasing the parking brake
- shifting the automatic transmission out of park position **P**
- starting the engine.

There is a risk of an accident and injury. When leaving the vehicle, always take the key with you and lock the vehicle. Never leave children unattended in the vehicle. Always keep the key out of reach of children.

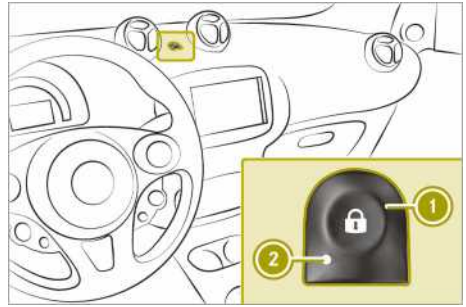

- ▶ To lock: press button ①. When the doors are locked, indicator lamp ② lights up.
- ▶ To unlock: press button ①.

Activating and deactivating the automatic locking feature

The activated automatic locking feature locks the vehicle automatically when the ignition is switched on and the vehicle is moving.

- ▶ When the engine is running, press and hold button ① for 5 seconds until a tone sounds.

Repeat the procedure to deactivate the automatic locking feature.

When the automatic locking function is activated, the locking mechanism engages audibly when you pull away. When the automatic locking function is deactivated, no sound occurs.

Activating the double-lock function

For United Kingdom only: the double-lock function prevents the doors from being opened from the inside.

⚠ WARNING

When the double locks are activated, the doors can no longer be opened from the inside. People in the vehicle can no longer get out, e.g. in hazardous situations. There is a risk of injury.

Therefore, do not leave any people unsupervised in the vehicle, particularly children.

dren, elderly people or people in need of special assistance. Do not activate the double lock when people are in the vehicle.

WARNING

If persons (particularly children) are exposed to heat or cold for a prolonged period, there is a risk of serious or even fatal injuries. Never leave persons (particularly children) unattended in the vehicle.

- ▶ Press button  twice.
The double-lock function is enabled.

Understanding the reversing feature

The side windows are equipped with an automatic reversing feature. If a solid object blocks or restricts a side window from closing during automatic operation, the side window opens again automatically. During the manual closing process, the side window only opens again automatically after the corresponding switch is released. The automatic reversing feature is only an aid. The driver is responsible for operating the side windows safely.

WARNING

The reversing feature does not react:

- to soft, light and thin objects, e.g. small fingers
- while adjusting

This means that the reversing feature cannot prevent someone being trapped in these situations. There is a risk of injury.

When closing, make sure that no body parts are in the closing area. If someone becomes trapped, press the  button to open the side window again.

Opening and closing the windows

Please note

WARNING

While closing the side windows, body parts in the closing area could become trapped. There is a risk of injury.

When closing make sure that no parts of the body are in the closing area. If somebody becomes trapped, release the switch or press the switch to open the side window again.

WARNING

Children could become trapped if they operate the side windows, particularly when unattended. There is a risk of injury.

When leaving the vehicle, always take the key with you and lock the vehicle. Never leave children unattended in the vehicle.

WARNING

If you close a side window again immediately after it has been blocked or reset, the side window closes with increased or maximum force. The reversing function is then not active. Parts of the body could be trapped in the closing area in the process. This poses an increased risk of injury or even fatal injury.

Make sure that no parts of the body are in the closing area. To stop the closing process, release the switch or push the switch again to reopen the side window.

The switches for both side windows are located on the driver's door. There is also a switch for the front-passenger window on the front-passenger door. The switch on the driver's door takes precedence.

Opening and closing the windows

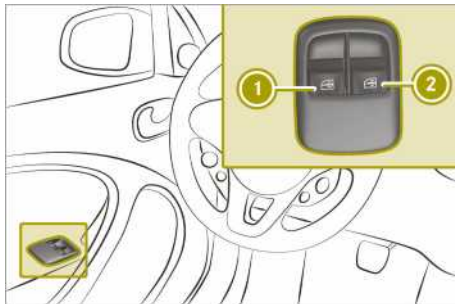

① Left side window

② Right side window

- ▶ To open: press the switch.
- ▶ To close: pull the switch.

Opening and closing windows fully in automatic mode

- ▶ To open the windows fully, press the switch beyond the point of resistance and release it.
- ▶ To close the windows fully, pull the switch beyond the point of resistance and release it.
- ▶ To stop automatic operation, press the switch again.

Opening and closing the hinged windows of rear doors

Opening the hinged windows

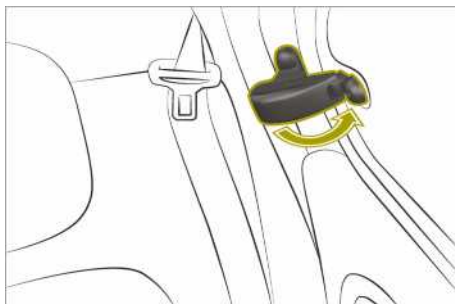

- ▶ Fold the lever forwards.
- ▶ Use the lever to push the hinged window out to the stop.
- ▶ Push the lever back until as far as it will go.

Closing the hinged windows

- ▶ Fold the lever forwards.
- ▶ Use the lever to pull in the hinged window.
- ▶ Push the lever back until as far as it will go.

Opening and closing the folding top

⚠ WARNING

During opening and closing, body parts in the sweep of the folding top can get trapped. There is a risk of injury.

When opening and closing make sure that no parts of the body are in the sweep.

Release the switch immediately if somebody becomes trapped.

The opening or closing will stop.

⚠ WARNING

Children could become trapped if they operate the folding top, particularly when unattended. There is a risk of injury.

When leaving the vehicle, always take the key with you and lock the vehicle. Never leave children unattended in the vehicle.

❗ Only open the folding top if it is free of snow and ice. Otherwise, malfunctions may occur.

Do not allow anything to protrude from the folding top. Otherwise, the seals could be damaged.

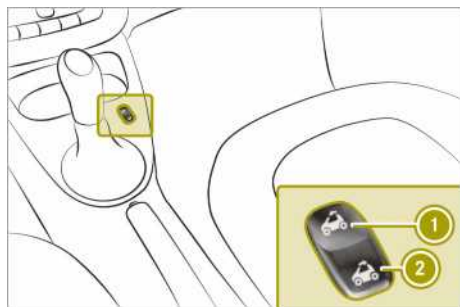

To open or close the folding top, the ignition must be switched on.

- ▶ To open: press the switch to position ① until the folding top is in the desired position.
- ▶ To close: press the switch to position ② until the folding top is in the desired position.

i It is possible to open or close the folding top while driving at speeds of up to 100 km/h.

Operating the climate control system

Useful information

The climate control system is only available when the ignition is switched on.

If the climate control system is deactivated, the air supply and circulation are switched off. The windows could mist up. You should therefore switch off the climate control system for brief periods only.

In air-recirculation mode, only the air inside the vehicle is recirculated and no fresh air is introduced. This is useful in a tunnel or when there are unpleasant odours outside the vehicle. In air-recirculation mode, the windows may mist up more quickly, particularly when the outside temperature is low. Therefore, switch on air-recirculation mode only briefly.

The integrated filter in the climate control system keeps out most particles of dust as well as pollen. The filter reduces the amount of air supplied to the vehicle interior. For this reason, always observe the interval for replacing the filter.

Operating the automatic climate control system

Switching the automatic climate control system on and off

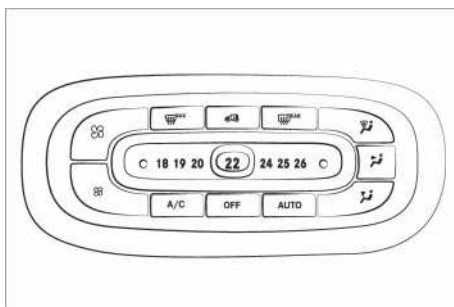

The ignition must be switched on in order to operate the blower. The engine must be running in order to operate all the functions of the automatic climate control system.







- ▶ To switch on: press the **AUTO** button. The indicator lamps below **AUTO** and **A/C** light up.
- ▶ To switch off: press the **OFF** button. The indicator lamp below **OFF** lights up.

Setting the temperature

- ▶ Move the slider in small increments to the left or right.

In automatic mode, the set temperature is maintained at a constant level. The air distribution and blower speed are regulated automatically.

Setting and switching the air distribution off

- ▶ Press one or more of the , ,  buttons.
 -  Demister vents
 -  Centre and side air vents
 -  Footwell vents



Increasing the blower speed

- ▶ Press the  button.

Decreasing the blower speed

- ▶ Press the  button.



Activating/deactivating air-recirculation mode

- ▶ Press the  button.
The indicator lamp above  lights up when air-recirculation mode is activated.

Switching "Cooling with air dehumidification" on or off



The "Cooling with air dehumidification" function cools and dehumidifies the air inside the vehicle during warm weather.

The engine must be running in order to use "Cooling with air dehumidification".

- ▶ To switch on: press the  and  button.
The indicator lamp below  lights up when the function is activated.



In damp weather, only switch off the "Cooling with air dehumidification" function briefly. Otherwise the windows can mist up more quickly.

Demisting the windscreen

- ▶ Press the  button.
The indicator lamp above  lights up when the windscreen is being demisted.
Use this setting only until the windscreen is clear again.



Demisting the rear window

When the rear window heating is activated, the exterior mirrors are also heated.

- ▶ Press the  button.
The indicator lamp above  lights up when the rear window heating is activated.

Use this setting only until the rear window is clear again.

Drying windows that are misted up on the inside

- ▶ Press the  button.
- ▶ Press the  button.
- ▶ If the windows are still misted up, press the  button.

Use this setting only until the windows are clear again.

Drying windows that are misted up on the outside

- ▶ Switch on the windscreen wipers.
- ▶ Press the  button.

Use this setting only until the windows are clear again.

Setting the pre-entry climate control at departure time using the on-board computer

Only for instrument cluster with colour display:

The "Pre-entry climate control at departure time" function heats or cools the vehicle interior before the scheduled departure time. The climate control runs until approx. 10 minutes after the set departure time.

The vehicle must be connected to the charger in order to activate pre-entry climate control. The battery charge and the charge output of the high-voltage battery must be sufficient.

If pre-entry climate control cannot be operated, a display message is shown in the on-board computer.

- ▶ Call up **Pre-heat/cool and charge** in the on-board computer.
- ▶ Press .
- ▶ Select one of the following settings:
 - **no pre-selection**
The pre-entry climate control is deactivated.
 - **Two stored departure times**
- ▶ Departure time > select **Activate** to activate the stored departure time. If Smart-Charging was selected before, this setting is also activated.

- ▶ Departure time > select **Change** to change the settings of a stored departure time.
- ▶ Set the value.
- ▶ Select **Smart-Charging** or **instant charging**.

A display message is shown with the selected settings.

If **Smart-Charging** is selected, the high-voltage battery charges at minimum cost while also conserving battery life.

Depending on the set departure time, charging of the high-voltage battery may not start immediately or may be interrupted during the charging process.

- i** The charging station must support the transmission of tariff information in order for the optimised charging process with Smart-Charging to be possible. If the charging station does not provide tariff information, set the preferred charging times on the "smart control" website.

- i** If **instant charging** is selected, the high-voltage battery is charged regardless of the cost information. A part of the charging may not be conducted until one to two hours before the departure time, in order for temperature control of the high-voltage battery to be carried out for the intended departure time.

Adjusting the air vents

Please note

⚠ WARNING

Very hot or very cold air can flow from the air vents. This could result in burns or frostbite in the immediate vicinity of the air vents. There is a risk of injury.

Make sure that all vehicle occupants always maintain a sufficient distance to the air outlets. If necessary, redirect the airflow to another area of the vehicle interior.

⚠ WARNING

If you pour cleaning fluid or disinfectant into the vehicle's ventilation system, it may ignite. There is a risk of fire.

Never spray these or other agents into the ventilation system. Always have work on the ventilation system carried out at a qualified specialist workshop.

Keep the following rules in mind for optimal climate control:

- Keep the air slots between the service cover and windscreen clear of blockages.
- Do not cover the vents or ventilation grilles in the vehicle interior.
- Open the air vents fully.

Opening and closing the air vents



- ▶ To open **1**: turn the vent outwards.
- ▶ To close **2**: turn the vent inwards.

Directing the air vents

- ▶ Turn the air vents upwards, downwards, to the left or to the right as desired.

Activating/deactivating the seat heating and steering wheel heating

⚠ WARNING

Repeatedly switching on the seat heating can cause the seat cushion, the backrest pad and parts of the steering wheel to become very hot. The health of persons with limited temperature sensitivity or a

limited ability to react to higher temperatures may be affected or they may even suffer burn-like injuries. There is a risk of injury.

Therefore, do not switch the seat heating on repeatedly.

! When the seat heating is switched on, the seat surface can be damaged as a result of objects being placed on the seats, for example, seat cushions, child seats and protective covers not approved by Mercedes-Benz.

Ensure that there are no objects on the seat surface when the seat heating is switched on.

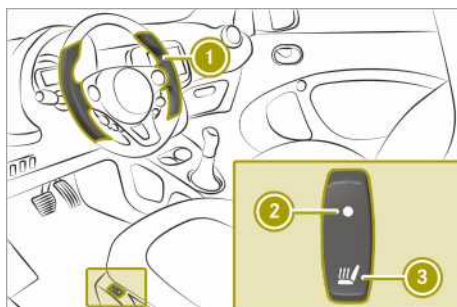

The seat heating only works when the ignition is switched on. Vehicles with the Winter package are additionally equipped with "Steering wheel heating" function ① and the "Rear seat heating" function. The rear seat heating buttons are located on the surface of the rear seat armrests.

► Press button ③.
Indicator lamp ② lights up when seat heating is activated.

Vehicles with the Winter package: steering wheel heating ① is also switched on when the driver's seat heating is activated.

Using the accessories

Using the cigarette lighter

! WARNING

You can burn yourself if you touch the hot heating element or the socket of the cigarette lighter.

In addition, flammable materials can ignite if:

- the hot cigarette lighter falls
- a child holds the hot cigarette lighter to objects, for example

There is a risk of fire and injury.

Always hold the cigarette lighter by the knob. Always make sure that the cigarette lighter is out of reach of children. Never leave children unattended in the vehicle.

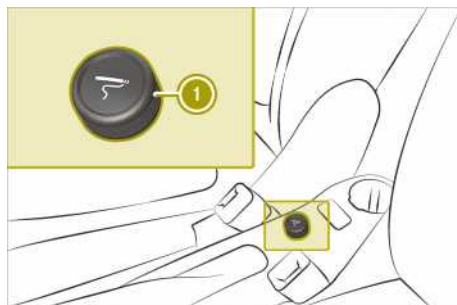

The cigarette lighter only works when the ignition is switched on.

► Press cigarette lighter ①.
When cigarette lighter ① is hot, it pops up automatically.

Using the ash tray

! The cup holder in the centre console is not heat resistant. Before placing lit cigarettes in the ashtray, make sure that the ashtray is fully inserted in the cup holder. Make sure that lit cigarettes do not fall into the cup holder.

Otherwise, the cup holder could be damaged.



- ▶ To open: lift up cover ①.
- ▶ To close: push down cover ①.
- ▶ To remove: pull the ashtray up and out.
- ▶ To insert: insert the ashtray into the cup holder.

Using the 12 V socket

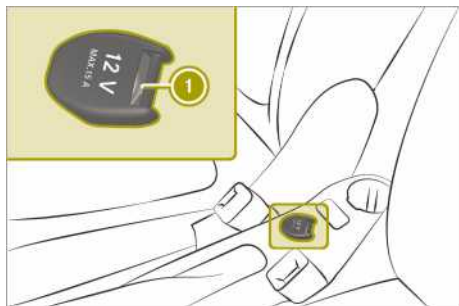

- ▶ Turn the key to position ① in the ignition lock.
- ▶ Lift up the cover of socket ①.
- ▶ Connect the device.

The socket can be used for accessories up to a maximum draw of 120 W (15 A).

If you use the socket for very long periods when the engine is switched off, the 12 V battery may discharge.

Fitting and removing the floormats

WARNING

Objects in the driver's footwell may restrict the clearance around the pedals or block a depressed pedal. This jeopardises

the operating and road safety of the vehicle. There is a risk of an accident.

Stow all objects securely in the vehicle so that they do not get into the driver's footwell. Always fit the floormats securely and as prescribed in order to ensure that there is always sufficient room for the pedals. Do not use loose floormats and do not place several floormats on top of one another.

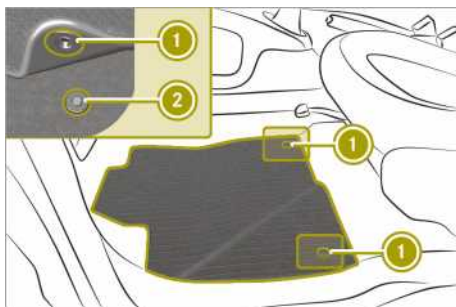

- ▶ Slide the driver's seat backwards.
- ▶ To install: press securing knobs ① onto retainers ②.
- ▶ To remove: release securing knobs ① from retainers ②.

Tablet bracket for iPad Air®

Useful information

iPad Air® tablets can be attached to the back of the front seats using the tablet bracket in the rear.

The tablet bracket offers the following functions:

- The attachment can be rotated 180° allowing the iPad® to be used in portrait or landscape mode.
- The attachment can be gently tilted allowing individual setting.

Please note

WARNING

The iPad® distracts the driver from the traffic situation. This could cause the driver to lose control of the vehicle.

There is a risk of an accident.

The driver must never use the iPad® while driving.

Always keep the iPad® away from the driver's field of vision.

⚠ WARNING

A bracket fitted in the vehicle without an attachment could be thrown around and thereby hit vehicle occupants, for example in the event of an accident, braking or a sudden change in direction.

There is a risk of injury.

Make sure that the entire tablet bracket is securely mounted in the fitting.

When removing the iPad® or the attachment, remove the entire tablet bracket.

- ❗ When adjusting and folding the seats with the tablet bracket mounted, contact with adjacent components may occur. If a charging cable is connected to the tablet bracket, the charging cable or the USB port may be damaged.

In order to avoid damage adjust the seats with the appropriate caution.

When folding down the rear bench seat, ensure that the rear bench seat does not collide with the tablet bracket.

You must observe the legal requirements for the country in which you are currently driving when operating the tablet bracket for iPad Air®.

Further information on the tablet bracket is available from any smart centre.

Mounting the tablet bracket

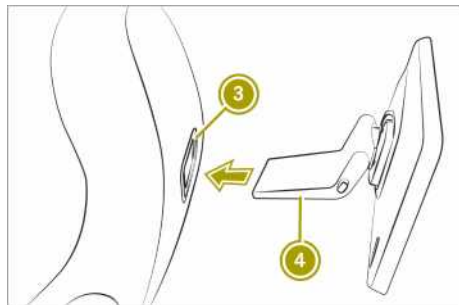
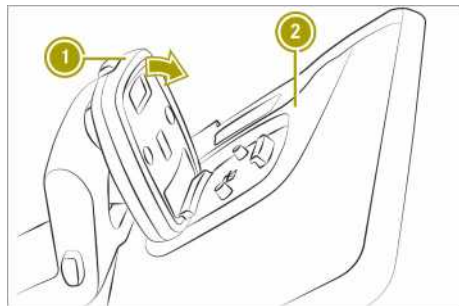

- ❗ Before mounting, ensure that no objects, e.g. coat hangers, are on the headrests.
- ▶ Mount bracket ① on the back of attachment ② until the bracket ① audibly engages.
- ▶ Insert tablet bracket ④ with the bracket forwards into fitting ③ until the tablet bracket audibly engages.

Affixing protective film

⚠ WARNING

The display of the iPad® may shatter in an accident. If there is no protective film on the display, you or other passengers may receive eye injuries, for example, caused by fragments.

There is a risk of injury.

Ensure that the protective film is affixed to the display.

i To avoid air bubbles or dirt getting under the surface, observe the following tips:

- Do not bend the protective film.
 - Do not touch the adhesive surface of the protective film.
 - Use disposable gloves to affix the protective film.
- ▶ Carefully clean the display of the iPad®.
 - ▶ The adhesive surface of the protective film is protected by a thin transparent backing film. Peel off half the backing film from the protective film.
 - ▶ Affix the upper edge of the protective film to the edge of the display by applying gentle pressure.
 - ▶ Slowly peel off the backing film from the protective film. At the same time, carefully apply pressure to the protective film with a suitable implement or plastic card such as a credit card and smooth over the surface.

If air bubbles or dirt particles are present after attaching the protective film, proceed as follows:

- ▶ Carefully remove the protective film from the display.
- ▶ Remove dust and impurities.
- ▶ Attach the protective film once again.

Inserting an iPad Air®

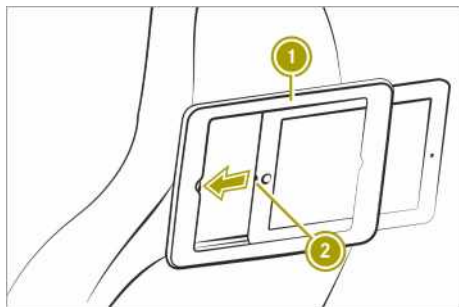

- ▶ Turn attachment ① so that the opening faces the vehicle interior.
- ▶ Insert iPad® with Lightning connection ② first into the attachment until the attachment audibly locks.
- ▶ Move the attachment to the desired position.

Charging the iPad Air® via the USB port

The iPad Air® can be charged via the USB port on the tablet bracket.

This additionally requires:

- a suitable USB adapter for the 12 V socket
 - a suitable USB data cable for the USB adapter and USB port on the tablet bracket
- ▶ Insert the USB adapter into the 12 V socket
 - ▶ Connect the USB data cable to the USB adapter and the USB port on the tablet bracket

Removing an iPad Air®

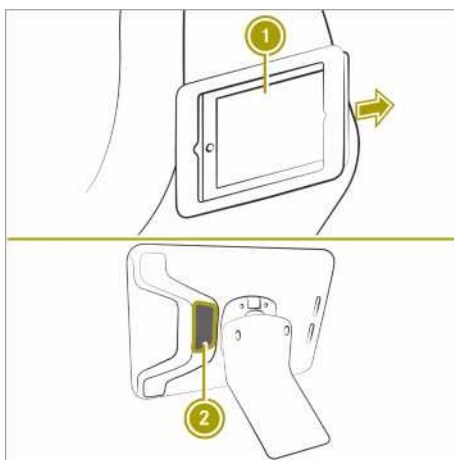

i The iPad® is not designed for the extreme temperatures which can be reached in a vehicle and may be damaged. For this reason, it is not recommended to leave the iPad® in a parked vehicle.

- ▶ Turn the attachment so that the opening faces the vehicle interior.
- ▶ Press button ② on the back of the tablet bracket.
The attachment unlocks and the iPad® is pushed a little out of the bracket.
- ▶ Remove iPad® ①.

Dismantling the tablet bracket

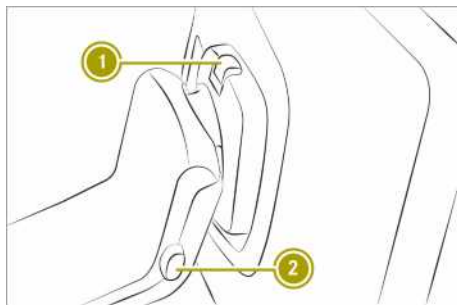

- ▶ Press button ② on the bracket.
- ▶ Pull the tablet bracket out of the fitting.
- ▶ To remove the bracket from the attachment, press release button ① on the attachment.

Parking

Please note

WARNING

When the engine is switched off, the automatic transmission shifts into neutral position **N**. The vehicle may roll away. There is a risk of an accident.

Always shift to parking position **P** before switching off the engine. Secure the parked vehicle against rolling away by applying the parking brake.

-  Always secure the vehicle correctly against rolling away. Otherwise, the vehicle or its drivetrain could be damaged.

Parking the vehicle

- ▶ Apply the parking brake.
- ▶ Shift the transmission to position **P**.
- ▶ Turn the key to position **0** in the ignition lock and remove it.
- ▶ On steep uphill or downhill gradients, turn the front wheels towards the kerb.
- ▶ Lock the vehicle.

Using the parking aid

Useful information

-  Pay attention to people and obstacles when manoeuvring or parking the car. The driver is responsible in these situations.

The electronic parking aid gives an acoustic indication of the distance between the vehicle and an obstacle behind it.

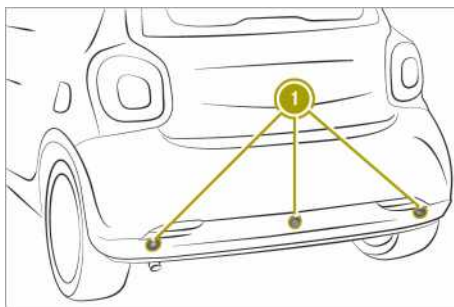

The parking aid uses three sensors ① in the rear bumper to monitor the area around the vehicle.

The parking aid measures the distance between the vehicle and an obstacle. If the proximity to the object behind the vehicle is less than 1.20 m, a short signal is issued. If the object is less than 30 cm away, a continuous warning tone is issued.

The parking aid might not function correctly under the following circumstances:



- the vehicle is on uneven terrain
- if there are obstacles below or above the sensor detection range
- the vehicle is on snow or near objects that absorb ultrasonic waves
- the vehicle is near strong ultrasonic sources, such as pneumatic hammers

If you engage reverse gear while the engine is running, the parking aid is activated.

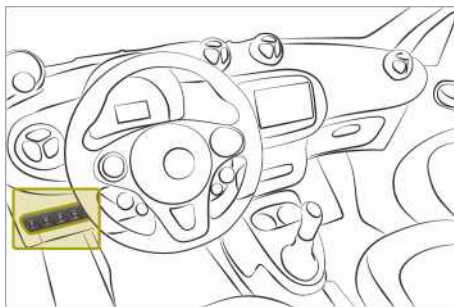
Activating and deactivating parking aid



The parking aid is automatically activated when you start the engine.

- Press the  switch.
When the parking aid is deactivated, the LED on the  switch lights up.

Using the reversing camera

Please note

The reversing camera is only an aid. It is not a substitute for your attention to the immediate surroundings. The responsibility for safe manoeuvring and parking remains with you. Make sure that there are no persons, animals or objects etc., in the manoeuvring area while manoeuvring or parking.

! If the rear of your vehicle is damaged, consult a qualified specialist workshop and have the reversing camera checked.

! Objects that are not at ground level appear further away than they actually are, for example:

- the bumper of the vehicle parked behind
- the drawbar of a trailer
- the ball coupling of a trailer tow hitch
- the tail-end of a lorry
- slanted posts

Only use the image from the reversing camera as a guide. You may otherwise damage your vehicle and/or the object.

Understanding the reverse camera functions

! Pay attention to people and obstacles when manoeuvring or parking the car. The driver is responsible in these situations.

! If the rear of your vehicle is damaged, consult a qualified specialist workshop and have the reversing camera checked.

The reversing camera is a visual parking and manoeuvring aid. It shows the area behind your vehicle with guide lines in the smart Media-System display.

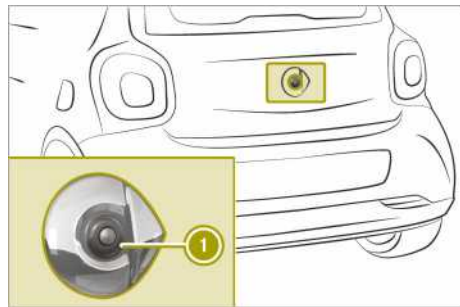

Reversing camera ① is located in the smart logo in the tailgate.

The area behind the vehicle is displayed as a mirror image in the smart Media-System display.

The reversing camera may show a distorted view of obstacles or show them incorrectly or not at all if:

- the obstacle is very close to the rear bumper
- the obstacle is underneath the rear bumper
- the obstacle is close to the tailgate handle
- the reversing camera is covered by additional accessories, e.g. a bicycle rack
- the reversing camera function is impaired due to pixel errors

The function of the reversing camera is limited:

- if the tailgate is open
- if there is heavy rain, snowfall or fog
- if the light conditions are too dark or too bright
- if there is fluorescent light shining, e.g. under fluorescent lamps or LED lighting
- if the outside temperature changes quickly
- if the camera lens is dirty, obstructed or misted up (► page 166)
- if the camera or the rear of your vehicle is damaged

i The display contrast may be impaired due to incident sunlight or other light sources, e.g. if the vehicle is being driven out of a garage. In this case, pay special attention.

i The use of the display can be considerably restricted due to pixel errors, for exam-

ple. In this case have the display repaired or replaced.

Guide lines in the display

Useful information

I Objects that are not at ground level appear further away than they actually are, for example:

- the bumper of the vehicle parked behind
- the drawbar of a trailer
- the ball coupling of a trailer tow hitch
- the tail-end of a lorry
- slanted posts

Only use the image from the reversing camera as a guide. You may otherwise damage your vehicle and/or the object.

Guide lines in different colours show the distance of obstacles from the rear of the vehicle. Static guide lines do not change when the steering wheel is turned. Dynamic guide lines change depending on the position of the steering wheel.

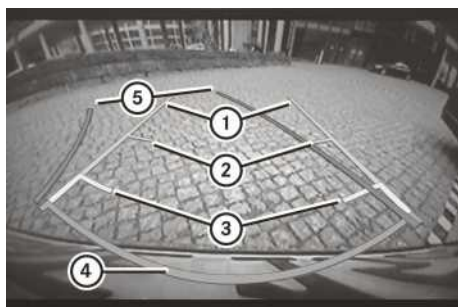

- ① Static: vehicle width including exterior mirrors
- ② Green, static: approx. 1.50 m
- ③ Yellow, static: approx. 0.7 m
- ④ Red, static: approx. 0.3 m
- ⑤ Blue, dynamic: vehicle width including exterior mirrors

The distance specifications only apply to objects that are at ground level.

Switching on the reversing camera

The ignition must be switched on to use the reversing camera.

- ▶ In the smart Media-System, select **Vehicle > Settings > Rear camera > Rear camera view settings > Rear camera view**.
- ▶ Confirm with **Done**.
- ▶ Engage reverse gear.
The area behind the vehicle is shown with guide lines in the smart Media-System display.

Switching off the reversing camera

After driving forwards briefly, the reversing camera will switch itself off.

Adjusting the reversing camera settings

- ▶ In the smart Media-System, select **Vehicle > Settings > Rear camera > Rear camera view settings**.

The following settings can be selected:

- Switch **Rear camera view** on or off.
- Switch **Static guidelines** on or off.
- Switch **Dynamic guidelines** on or off.
- ▶ Select the desired settings.
- ▶ Confirm with **Done**.

Adjusting reversing camera display settings

- ▶ In the smart Media-System, select **Vehicle > Settings > Rear camera > Image settings**.
- ▶ Adjust the values for **Brightness, Saturation** and **Contrast**.
- ▶ Confirm the display settings with **Done**.

Locking the vehicle

WARNING

If children are left unsupervised in the vehicle, they could:

- open doors, thereby endangering other persons or road users
- get out and be struck by oncoming traffic
- operate vehicle equipment and become trapped, for example

In addition, the children could also set the vehicle in motion by, for example:

- releasing the parking brake
- shifting the transmission out of park position **P**
- starting the vehicle's drive system

There is a risk of an accident and injury.

When leaving the vehicle, always take the key with you and lock the vehicle. Never leave children and animals unattended in the vehicle. Keep the keys out of the reach of children.

- ▶ Press the  button on the key. The turn signals flash twice.

- ▶ Close the service cover.
- ▶ Press the  button on the key. The alarm system is primed after approximately 30 seconds.

Deactivating and switching off the alarm

- ▶ Press the  button on the key.

Priming and deactivating the anti-theft alarm system

Useful information

The immobiliser prevents the vehicle from being started without the correct key. It is switched on and off automatically.

The anti-theft alarm system triggers a visual and audible alarm if a door, the tailgate or the service cover is opened.

The alarm is not switched off, even if, for example, you close the open door that has triggered it.

Priming

- ▶ Close the doors.
- ▶ Close the tailgate.

Overview of the on-board computer

Please note

⚠ WARNING
 If you operate information and communication equipment integrated in the vehicle when driving, you could be distracted from the traffic situation. This could also cause you to lose control of the vehicle. There is a risk of an accident.
 Only operate this equipment when the traffic situation permits. If you cannot be sure of this, stop the vehicle paying attention to road and traffic conditions and operate the equipment with the vehicle stationary.

⚠ WARNING
 If the instrument cluster has failed or malfunctioned, you may not recognise function restrictions relevant to safety. The operating safety of your vehicle may be impaired. There is a risk of an accident.
 Drive on carefully. Have the vehicle checked at a qualified specialist workshop immediately.

If the operating safety of your vehicle is impaired, you must park the vehicle safely as soon as possible. Consult a qualified specialist workshop.

Display messages and displays in the instrument cluster are only shown for certain systems. Vehicle owners and drivers are responsible for ensuring that the vehicle is operating safely. A vehicle which is not operating safely can cause an accident.

The display shows the outside temperature on the far right in the header. Drivers must pay special attention to road conditions when temperatures are around freezing point. Changes in the outside temperature are displayed after a short delay.

After opening the door, the on-board computer is activated for approximately 15 minutes. To permanently activate the on-board computer, the ignition must be switched on.

Monochrome display overview

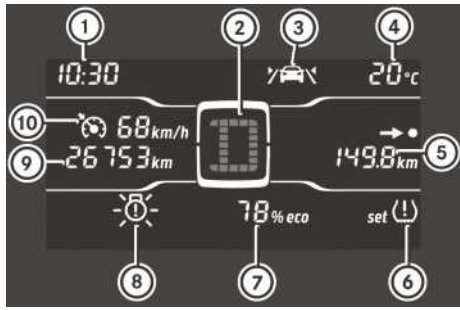

- ① Time
- ② Transmission display
- ③ Lane Keeping Assist indicator lamp
- ④ Outside temperature display and black ice warning [❄]
- ⑤ Trip meter, remaining range, service display
- ⑥ Tyre pressure monitor
- ⑦ eco score display
- ⑧ Brake lamp failure warning lamp
- ⑨ Total distance recorder
- ⑩ Cruise control, limiter

Colour display overview

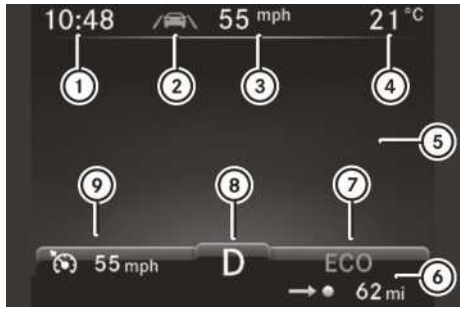

- ① Time
- ② Lane Keeping Assist indicator lamp
- ③ Digital speedometer
- ④ Outside temperature display with black ice warning [❄]
- ⑤ Display field for display messages, menus and lists
- ⑥ Remaining range
- ⑦ ECO mode, radar-based recuperation

- ⑧ Transmission display
- ⑨ Cruise control, limiter

Calling up displays

Calling up displays (monochrome display)

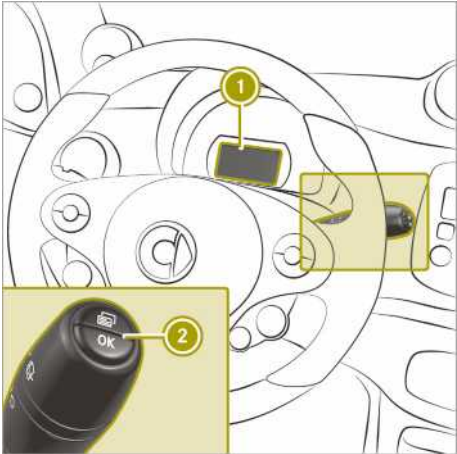

- ① Monochrome display
- ② Buttons on the multifunction lever

- ▶ To scroll forward at menu level, briefly press the button on multifunction lever.
- ▶ To directly call up the trip meter, press and hold the button on multifunction lever.
- ▶ Press and hold on the multifunction lever to reset the values.

The following displays can be called up one after another:

- trip meter
- remaining range
- service due date
- setting the time
- activating/deactivating Active Brake Assist
- restarting the tyre pressure monitor

Calling up displays (colour display)

Calling up displays

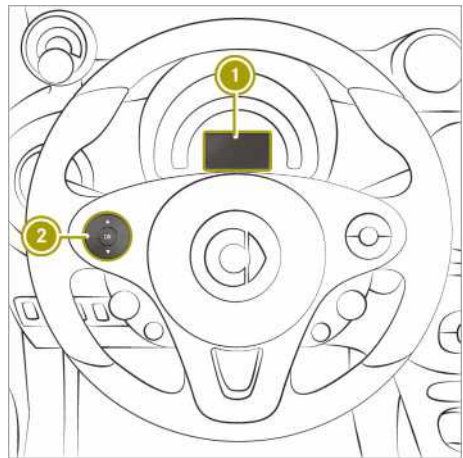

- ① Colour display
- ② Left control panel

- ▶ Briefly press or on left control panel ②, to scroll forwards or backwards.
- ▶ Press and hold or on left control panel ②, to directly call up the **Distance** display.

The following displays can be called up one after another:

- **Distance**
- Trip computer **from start**
- Trip computer **from reset**
- **eco score from start**
- **Fuel consumption bar chart**
- **Energy flow**
- **Pre-heat/cool and charge**
- **Messages and service**
- **Settings**
- **Digital speedometer**

Distance display



- ① Trip meter
- ② Total distance recorder

Trip computer display



- ① Elapsed time
- ② Distance
- ③ Average speed
- ④ Average energy consumption

The data in the **from start** menu refers to the start of the journey, whilst the data in the **from reset** menu refers to the last time the submenu was reset.

If the ignition remains switched off for longer than four hours, the **from start** values in the instrument cluster are reset. The eco score display is also reset automatically.

eco score display

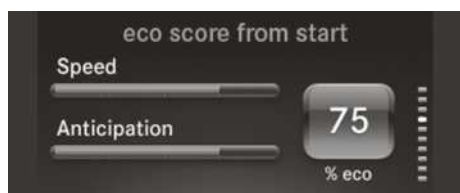

The eco score display provides feedback on how economical the driver's driving behaviour is (> page 71).

If the ignition remains switched off for longer than four hours, the eco score display will be automatically reset.

When the eco score display is reset, the **from start** trip computer in the smart Media-System and the eco score display are also reset in the smart Media-System.

Fuel consumption bar chart display

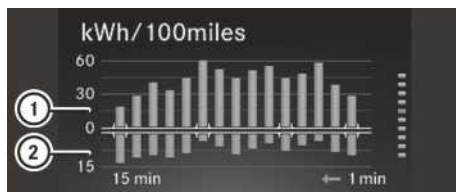

- ① Energy consumption
- ② Recuperation

The display shows the average energy consumption and recuperation over the previous 15 minutes.

Energy flow display



- ① Total output
- ② Output for electrical consumers

The total output shows the driver the sum of the energy currently flowing from the battery. The colour of the battery shows whether energy is being consumed or recuperated:

- Battery symbol is orange: energy is being consumed.
- Battery symbol is green: energy is being recuperated.
- Battery symbol is grey: energy consumption and recuperation are equal or both at 0 kW.

The output for electrical consumers shows the driver what output is needed to operate electrical consumers, e.g. climate control systems or the radio. If the value is kept as low as possible, a greater range is achieved.

Pre-entry climate control and charging display



- ① Time of the full charge
- ② Charge status of the battery
- ③ Departure time
- ④ Smart-Charging
- ⑤ Charge current and charge output

An arrow underneath the battery indicates the charge status of the battery at the departure time. The charge status and the time of complete charge are only predicted approximately. The time of complete charge cannot be displayed when Smart-Charging is activated.

Information on the "Pre-entry climate control at departure time" function (▷ page 95).

Messages and service display

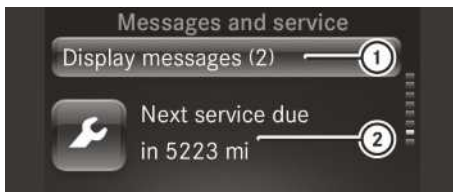

- ① Message memory
- ② Next service due date

The display shows the number of display messages in the message memory and the next service due date.

indicates a minor service. indicates a major service.

To show the display messages, the ignition must be switched on.

- ▶ Press **OK** to scroll through the display messages.

Current information on the type of service can be obtained at a smart centre or a qualified specialist workshop.

Digital speedometer display

The display shows the digital speedometer. The digital speedometer in the header is hidden.

United Kingdom only: the digital speedometer in the header continues to be displayed.

Setting values

Setting values (monochrome display)

Setting the time

- ▶ Press repeatedly until **SET** is shown next to the time.
- ▶ Press **OK** until the hour display flashes.
- ▶ Set values.

Deactivating or activating Active Brake Assist

- ▶ Press several times until and **SET** are displayed.
 - ▶ Press **OK** until **on** or **OFF** appears below .
- The indicator lamp lights up when Active Brake Assist is deactivated.

Resetting values

The trip meter display and eco score display can be reset.

- ▶ Scroll to the desired display.
- ▶ Press **OK** for three seconds.

Setting values (colour display)

Setting values

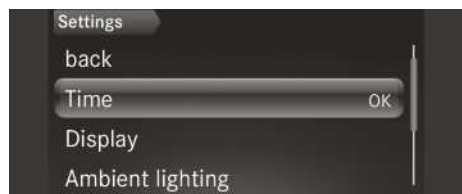

- ▶ Press or to scroll to **Settings**.
- ▶ Press or to scroll to the desired menu.

- ▶ Press or to set the desired data.
- ▶ Press to confirm.

Resetting values

- ▶ Press .
- ▶ Select **yes** and press to confirm.

Setting the time

- ▶ Select **Settings > Time > Set the time.**
- ▶ Set values.
Vehicles with smart Media-System: the time and time format are set in the smart Media-System.

Setting the time format

- ▶ Select **Settings > Time > 12/24 Time format.**
- ▶ Set the value.

Adjusting the instrument cluster lighting

- ▶ Select **Settings > Display > Display/switch brightness.**
- ▶ Set the value.

Displaying the digital speedometer in the header

- ▶ Select **Settings > Display > Digital speedometer.**
- ▶ Select the **Disp. addit. dig. speedo.** function.
 The digital speedometer is displayed in the header.

England only: the digital speedometer in the header cannot be hidden.

Setting the unit for speed in the digital speedometer

- ▶ Select **Settings > Display > Digital speedometer > Unit.**
- ▶ Set the value.
 The following values are set:
 - Digital speedometer display
 - Digital speedometer in the header

England only: only the display unit of the digital speedometer is set.

Setting the unit of measurement for distance

- ▶ Select **Settings > Display > Units of distance.**
- ▶ Set the value.

Setting the temperature unit

- ▶ Select **Settings > Display > Units of temperature.**
- ▶ Set the value.

Switching radar-based recuperation off and on

To switch on radar-based recuperation, the conditions for activation must be fulfilled and the ignition must be switched on.

- ▶ Select **Settings > Radar assist.recuperation > on or off.**

Information on radar-based recuperation (▷ page 69).

Deactivating or activating Active Brake Assist

The ignition must be switched on in order to set Active Brake Assist.

- ▶ Select **Settings > Active Brake Assist > on or off.**

Information on Active Brake Assist (▷ page 57).

Starting the tyre pressure monitor

- ▶ Select **Settings > Tyre pressure monitor.**

Information on the tyre pressure monitor (▷ page 161).

Switching ambient lighting on/off

- ▶ Select **Settings > Ambient lighting > On.**

Setting the brightness of the ambient lighting

- ▶ Select **Settings** > **Ambient lighting** > **Brightness**.
- ▶ Set the value.

Setting the language

- ▶ Select **Settings** > **Language (Language)**.
- ▶ Set the value.

Operating and setting the smart Audio-System

smart Audio-System overview







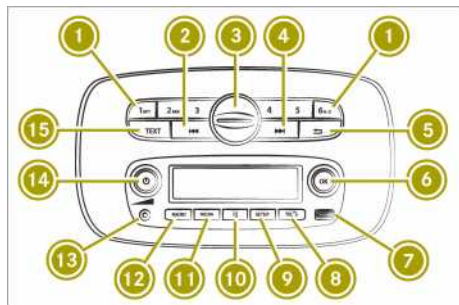

WARNING



If you operate information and communication equipment integrated in the vehicle when driving, you could be distracted from the traffic situation. This could also cause you to lose control of the vehicle. There is a risk of an accident.

Only operate this equipment when the traffic situation permits. If you cannot be sure of this, stop the vehicle paying attention to road and traffic conditions and operate the equipment with the vehicle stationary.









You must observe the legal requirements for the country in which you are currently driving when operating the smart Audio-System.



- ① Number keys **1** - **6**
- ②  Previous station or track
- ③ USB1 port and bracket connection for mobile phone with smart cross connect app
- ④  Next station or track
- ⑤  Goes back one menu level higher
- ⑥ Control for menu selection and station list,  button
- ⑦ USB2 port
- ⑧  Telephone menu to accept or reject calls
- ⑨  System settings
- ⑩  Mute
- ⑪  Plays back media from external data carriers

- ⑫  Switches on the radio and selects the waveband
- ⑬ External audio equipment (AUX connection)
- ⑭ Volume control,  button
- ⑮  Sets the radio text





Operating and setting the smart Audio-System

- ▶ To switch on or off: press .
- ▶ To scroll through menus: turn control .
- ▶ To select menu options: turn control  and press the .
- ▶ To navigate to the next-highest folder: press the .
- ▶ To set values: turn control  and press the .
- ▶ To increase or decrease the volume: turn control .

Using external devices

Useful information

You can connect the following external devices:

- USB devices, iPods® and MP3 players (USB port)
 - External audio equipment (AUX connection)
 - Bluetooth® devices, such as mobile phones
- External devices can be charged at USB ports  and  when the ignition is switched on. It is better to use USB port  for charging as it supplies a higher charge current. To charge an external device remove the cover on USB port .

Using the smartphone bracket

Useful information

-  Operating smartphones in the smartphone bracket is permitted exclusively in connection with the smart cross connect app.

The smartphone bracket keeps your mobile phone secured in the vehicle. In order to use the smart cross connect app, rotate the mobile phone to landscape mode.

You can use the USB port behind the smartphone bracket on the left to charge your mobile phone during the journey with a suitable charging cable. Mobile phones and other USB devices can be charged when the ignition is switched on.

The smartphone bracket is suitable for mobile phones with the following dimensions:

- thickness: 6 – 10 mm
- width: 55 – 82 mm
- length: 120 – 162 mm

Further information is available from any smart centre.

Removing and fastening the cover of the USB1 port

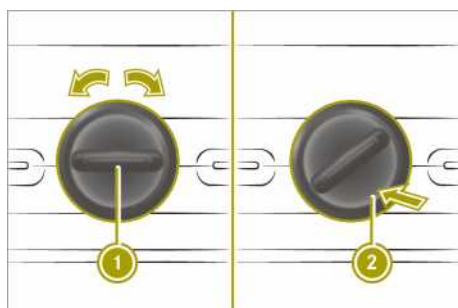

- ▶ **To remove:** turn the cover anti-clockwise using handle ①.
- ▶ Press on marking ②.
- ▶ Remove the cover.
- ▶ **To secure:** place the cover in position ②.
- ▶ Turn the cover clockwise using handle ①.

Fitting the smartphone bracket

- ▶ Remove the cover from the USB1 port.
- ▶ Connect the smartphone bracket to USB1 and turn the locking mechanism clockwise.

Inserting and removing the mobile phone

- ▶ **To insert:** press the right-hand raised button on the bottom edge of the smartphone bracket.
The upper tensioning arm opens.
- ▶ If necessary, press the left-hand button on the bottom edge of the smartphone bracket.
The tensioning arms on the side open.
- ▶ Set the mobile phone in the smartphone bracket.
- ▶ If necessary, press the tensioning arms on the side together to set them to the size of the mobile phone.
- ▶ Press down the upper tensioning arms to secure the mobile phone.
- ▶ **To remove:** press the right-hand raised button on the bottom edge of the smartphone bracket.
The upper tensioning arm opens.
- ▶ Remove the mobile phone from the smartphone bracket.

Operating the smart Audio-System via the mobile phone

You can use the smart cross connect app for iOS and Android™ to operate the smart Audio-System via a mobile phone.

- ▶ Download the smart cross connect app from the App Store® (iOS) or Google Play™ (Android™) and install it on the mobile phone.
- ▶ Connect the mobile phone with the smart Audio-System via Bluetooth®.
- ▶ Insert the mobile phone into the bracket.

Further information about operating the smart Audio-System via mobile phone can be found in the smart cross connect app user's guide.

Adjusting the system settings

Setting the system language

- ▶ Press the **SETUP** button.
- ▶ Select **Language**.
The list of languages appears.
- ▶ Select the language.

Switching the time on or off

- ▶ Press the **SETUP** button.
- ▶ Select **Clock**.
- ▶ Select **ON** or **OFF**.

Setting the time

- ▶ Press the **SETUP** button.
- ▶ Select **Clock**.
- ▶ Select **Set Time**.
- ▶ Set the time.

Setting the time format

- ▶ Press the **SETUP** button.
- ▶ Select **Clock**.
- ▶ Select **Format**.
- ▶ Choose one of the following time formats:
 - **Am/Pm**
 - **24hr**

Adjusting the audio settings

Adjusting the sound

- ▶ Press the **SETUP** button.
- ▶ Select **Audio**.
- ▶ Select **Sound**.
- ▶ Select the desired sound settings:
 - **Bass**: adjusts the bass.
 - **Treble**: adjusts the treble.
 - **Bal.**: adjusts the surround sound (balance) to left or right.
 - **Fade**: adjusts the surround sound (balance) to the front or back.

Switching the bass boost on or off (vehicles without JBL sound system)

- ▶ Press the **SETUP** button.
- ▶ Select **Audio**.
- ▶ Select **Bass Boost**.
- ▶ Select **ON** or **OFF**.

Resetting audio settings

- ▶ Press the **SETUP** button.
- ▶ Select **Audio**.
- ▶ Select **Audio Default**.
- ▶ Select **Yes**.

Adjusting the volume to the vehicle speed (vehicles without JBL sound system)

- ▶ Press the **SETUP** button.
- ▶ Select **Audio**.
- ▶ Select **Speed Vol..**
- ▶ Select the desired level.
The higher the level, the higher the volume will be at increasing road speeds.

Listening to the radio

Switching on the radio

- ▶ Press the **⏻** button.
- ▶ Press the **RADIO** button.

The smart Audio-System receives data transmitted via the Radio Data System (RDS).

Selecting a waveband

- ▶ Press the **RADIO** button repeatedly until the desired waveband appears.

If available, you can switch between the following wavebands:



- **FM1**
- **FM2**
- **DR1** (digital radio)
- **DR2** (digital radio)
- **AM**

Selecting stations manually



FM and AM waveband

- ▶ Press the **⏭** or **⏮** button to set the desired frequency.

Digital radio frequency range

- ▶ To select the desired station, press the  or  button.



Setting a station from the station list

- ▶ Press  in radio mode. The station list appears.
- ▶ Select a station.
- ▶ Press  to confirm.

Updating the station list

- ▶ Press the  button until you hear a tone.

Storing a station

- ▶ Select a waveband.
- ▶ Set the station.
- ▶ Press a number key  to  until you hear a tone. The station set for this waveband will be saved at the button you have pressed.

Selecting a stored station

- ▶ Select a waveband.
- ▶ Press a number key for the stored station.

Switching traffic announcements on/off

- ▶ Press the  button.
- ▶ Select **Radio**.
- ▶ Select **TA**.
- ▶ Select **ON** or **OFF**.

Interrupting a traffic announcement

- ▶ During a traffic announcement, briefly press .

Displaying radio text in FM radio

- ▶ Press the  button. If radio text is available, it will be displayed.

Digital radio (if available)

Information on DAB



-  Any electronic devices taken into the vehicle may seriously impair radio and DAB radio reception.

Digital radio or DAB (Digital Audio Broadcasting) is a digital transmission standard optimally designed for the mobile reception of radio transmissions. Several programmes are combined into so-called ensembles and transmitted on a single frequency. Some stations only transmit programmes at certain times. If you have selected a programme that has subsequently been removed from the ensemble, it will no longer be received. You will continue to receive the other programmes in the ensemble. Select either a different programme or a different ensemble.

-  DAB cannot be received everywhere in Europe.

Displaying radio text

This function provides additional data transmitted in the DAB waveband (DR1 and DR2). Besides displaying the artist and track names, information on the current programme may also be available.

- ▶ Press the  button.
- ▶ Select **Radio text**. The  dot shows that radio text is activated.

Setting alerts

If this function is activated, certain programme categories allow another broadcast to interrupt the current audio playback. Numerous categories can be selected, such as news, business news, sports news etc.

A prerequisite for the reception is that broadcasters process the relevant information. This function is only available in certain countries.

- ▶ Call up the setup menu (▷ page 113).
- ▶ **Radio > DR Interrupt >** Select the desired category.
The  dot shows the active settings.

- i** Several categories can be selected.
Repeat the procedure if necessary.

Displaying the EPG

EPG (**E**lectronic **P**rogram **G**uide) is available in the DAB waveband (DR1 and DR2).

If the station supports EPG, you can use the EPG (Electronic Programme Guide) to display the current and the following two radio programmes. At the very least, the programme overview contains the name, time and length of each programme.

- ▶ Press the  button.
- ▶ Select **EPG**.
- ▶ Select the desired station.

Switching on Intellitext™

If the station supports Intellitext™, you can have additional information displayed, such as news, headlines, business news, sports news etc. A prerequisite for the reception is that broadcasters process the relevant information. Intellitext™ is only available in certain countries.

- ▶ Press the  button.
- ▶ Select **Intellitext**.

Using a mobile phone

Connecting a mobile phone

Useful information

The Bluetooth®-capable mobile phone must be compatible with the smart Audio-System. Overview of compatible mobile phones:
<http://www.smart.com/connect>.

To make a call, Bluetooth® must be activated on the mobile phone and the smart Audio-System.







Once outside the Bluetooth® reception range, the connection is terminated automatically.

To clearly identify a mobile phone, change the device name (see the manufacturer's operating instructions).



Activating Bluetooth® on a mobile phone

- ▶ Activate Bluetooth® on the mobile phone (see the manufacturer's operating instructions).
- ▶ Search for devices.

Switching on the Bluetooth® function of the smart Audio-System

- ▶ Press the  button.
- ▶ Turn control  to **Bluetooth** and confirm with .
- ▶ Turn control  to **ON** and confirm with . The  dot shows the active setting.

Authorising a mobile phone on the smart Audio-System

- ▶ Press the  button.
- ▶ Select **Scan devices**.
The system searches for available mobile phones and displays them in a list.
- ▶ Select the mobile phone and confirm with .
- ▶ Do one of the following:
 - if a code appears in the smart Audio-System display and on the mobile phone, confirm it on the mobile phone
 - if the code **0000** appears in the smart Audio-System display, enter it and confirm it on the mobile phone

A maximum of five mobile phones can be authorised. However, only one authorised mobile phone can be connected with Bluetooth® at a time.

Loading and updating the phone book

- ▶ Press the  button.
- ▶ Select **Settings > PB download**.
- ▶ If necessary, accept the access confirmation on the mobile phone.

If the mobile phone supports the Bluetooth® PBAP (Phone Book Access Profile) profile, the phone book and call lists will be transferred after you connect.

Removing a mobile phone from the list (de-authorising)

- ▶ Press the **TEL** button.
- ▶ Select **Del. device**.
Authorised mobile phones are displayed.
- ▶ Select the mobile phone to be removed.
- ▶ Select **YES**.

After de-authorisation, the Bluetooth® connection to the mobile phone is no longer established automatically.

Connecting another authorised mobile phone

- ▶ Activating Bluetooth® on a mobile phone
- ▶ Press the **TEL** button.
- ▶ Select **Sel. device**.
All authorised mobile phones are displayed. The currently connected mobile phone is indicated by a dot.
- ▶ Select the desired mobile phone from the list.

Setting the sound

Adjusting the call volume

- ▶ Press the **TEL** button.
- ▶ Select **Settings > Volume > Call**.
- ▶ Select the setting.

Switching the smart Audio-System ringtone on and off

- ▶ Press the **TEL** button.
- ▶ Select **Settings > Ringtone**.
- ▶ To switch on: select **Car**.
- ▶ To switch off: select **Phone**.

Adjusting the ringtone volume

- ▶ Press the **TEL** button.
- ▶ Select **Settings > Volume > Ring**.
- ▶ Select the setting.

Telephone operation

Calling a contact from the phone book

To call a contact in the phone book, the mobile phone telephone book first has to be imported into the smart Audio-System.

- ▶ Press the **TEL** button.
- ▶ Select **Telephone book**.
- ▶ Select the contact.
The details for the contact are displayed.
- ▶ Dial the selected phone number.
- ▶ Press the **OK** button.

Dialling a number

- ▶ Press the **TEL** button.
- ▶ Select **Dial a number**.
An input screen appears.
- ▶ Enter the number.
- ▶ Press the **OK** button.
- ▶ Select .

Using call lists to call contacts

To call a contact in a call list, the mobile phone telephone book first has to be imported into the smart Audio-System.

- ▶ Press the **TEL** button.
- ▶ Select **Call lists**.
- ▶ Select **Dialed, Received** or **Missed**.
- ▶ Select an entry from the list.

Calling the last number dialled

- ▶ Press and hold the **TEL** button until the call is established.



Accepting a call

- ▶ Press the **TEL** button.



Rejecting a call

- ▶ Press and hold the **TEL** button until the call is rejected.

Holding and continuing a call

- ▶ To place a call on hold: select .
- ▶ To continue the call: press the .

Transferring a call to the mobile phone

- ▶ Select .
- ▶ To transfer the call back to the smart Audio-System: press .

Entering numbers or characters during a call

- ▶ Select #123.
- ▶ Enter numbers or characters.

Ending a call

- ▶ Press the .

Using voice control of the mobile phone

Useful information

Voice control of the connected mobile phone can be used (see manufacturer's operating instructions). Not all voice control services are supported by the smart Audio-System.

Voice control must be activated in the settings menu of the mobile phone.

Starting voice control of the mobile phone

- ▶ Connect the mobile phone with the smart Audio-System via Bluetooth®.
- ▶ Press the  button on the steering wheel.
A message appears in the display of the smart Audio-System and a tone sounds. Voice control of the mobile phone is active.
- ▶ Say a command.

Ending voice control of the mobile phone

- ▶ Press the  button on the steering wheel.

or

- ▶ Press the  button.
Voice control of the mobile phone is ended.

Operating external data storage media

Useful information

You can switch between the following media sources, depending on the type of external data carrier connected:

- USB 1 or iPod 1
- USB 2 or iPod 2
- AUX (external audio equipment)
- BT Audio (with Bluetooth® connected device, such as a mobile phone)

Selecting external data carriers



- ▶ Press the  button repeatedly until the desired media source appears in the display.

Operating a USB device or iPod®



Connecting a device

- ▶ Connect the device to the USB port.
The device is activated automatically and the first track is played.

Selecting a track

- ▶ In USB mode, press the  button.
Available tracks or folders are displayed.
- ▶ Turn control .
- ▶ Press  to confirm.

Rapid search

- ▶ Press the  button.
An entry field appears.
- ▶ To enter characters, turn control  and press the .

Skipping to the next or previous track

- ▶ Press the **▶▶** or **◀◀** button briefly to skip to the next track or press longer for rapid scrolling.

Switching random track sequence on/off

- ▶ Press the **◀◀** button.

Switching the repeat function on/off

- ▶ Press the number key.

Selecting a track from a category with an iPod® connected

- ▶ Press the **OK** button.
- ▶ Select the category from a list. Different categories, such as playlists, artists or albums, can be selected, depending on the connected device.

Displaying metadata

- ▶ Press the **TEXT** button repeatedly until the desired metadata is displayed.

Operating external audio equipment (AUX)

Connecting a device

- ▶ Connect the device to the AUX jack. Use the **MEDIA** button to access the media on a connected AUX device.

Adjusting the volume of external audio equipment

- ▶ Press the **SETUP** button.
- ▶ Select **Audio**.
- ▶ Select **AUX In**.
- ▶ Select one of the following options for the volume:
 - **Low**
 - **Medium**
 - **High**

Bluetooth® device operation

Connecting a device

- ▶ Connect a Bluetooth® audio device the same way you connect a mobile phone with Bluetooth®.

Skipping to the next or previous track

- ▶ Press the **▶▶** or **◀◀** button briefly to skip to the next track or press longer for rapid scrolling.

Displaying metadata

- ▶ Press the **TEXT** button repeatedly until the desired metadata is displayed.

Operating and setting up the smart Media-System



Operating the smart Media-System

Please note

Some functions are restricted while driving.

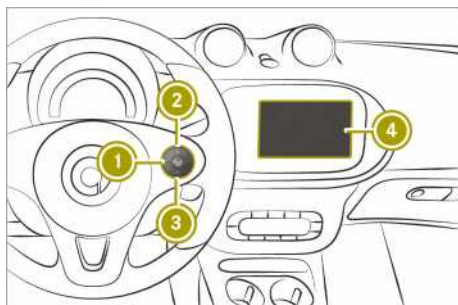
Controls



- ①  Switches voice control system on and off, accepts and ends a phone call
- ②  Increases the volume
- ③  Reduces the volume
- ④ smart Media-System display

Voice control system

The following functions are possible using the voice control system of the smart Media-System:

- enter a destination for navigation
- make a call
- start an application

Controls on the smart Media-System

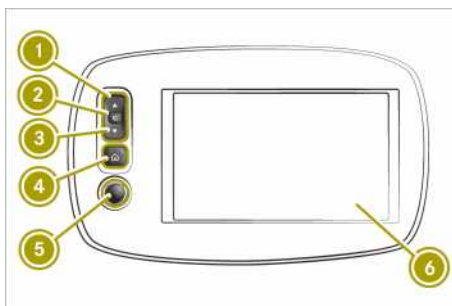

- ① Previous station or track and fast rewind
- ② Mute
- ③ Next station or track and fast forward
- ④ Switches to the home screen
- ⑤  On/off button and volume control
- ⑥ Touchscreen

Ports on the centre console

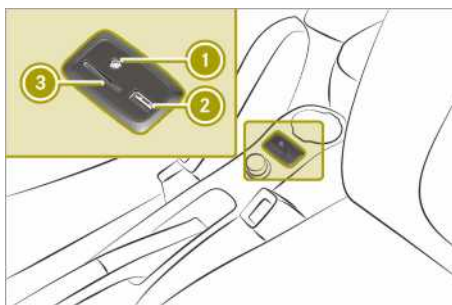

- ① Port for external audio equipment (AUX)
- ② USB port
- ③ SD card slot

Some devices, for example mobile phones or USB drives, connect with the smart Media-System via USB port ②. External devices with 5 V (1 A) can be charged on USB port ② when the ignition is switched on.

Overview of home screen



- ① Radio station, media track
- ② Number of messages in the message memory
- ③ Status of the mobile phone and field strength of the mobile phone network
- ④ Outside temperature
- ⑤ Time
- ⑥ Map
- ⑦ Next navigation manoeuvre
- ⑧ Context menu
- ⑨ Distance to the destination and estimated time of arrival
- ⑩ Favourites menu
- ⑪ Main menu
- ⑫ Telephone menu, status of the mobile phone and field strength of the mobile phone network

► To call up a function, tap on an area on the home page or on a symbol.

The following functions can be selected:

- ①: to switch to radio or media application
- ②: to call up message memory
- ③: to switch to telephone application
- ④: to call up the weather forecast for the current location
- ⑤: to display time and temperature in full screen or to call up time settings
- ⑥: to switch to full screen navigation view
- ⑧: to change language, change home page, remove an SD card or switch off the display
- ⑩: to view, call up or change favourites
- ⑪: to call up the main menu
- ⑫: to switch to telephone application

i The home screen can be set to display the energy flow.

If the home page is set so as to display the eco score, you can switch to the eco score application by tapping on the area.

When Android Auto™ or MirrorLink® is active, another symbol is displayed on the home page. You can switch to the relevant smart-phone screen application by tapping on the symbol.

Switching the smart Media-System on and off

Switching on automatically

► Start the engine.

Switching off automatically

► Switch off the ignition and open the door.

Switching on and off manually

► Press the  button.

Restarting

► Press the  button.
The smart Media-System shuts down and restarts.

i The restart can take several minutes. During the restart, the audio volume cannot be adjusted.

Scrolling through a menu or list on the touchscreen

- Touch the touchscreen with your finger.
- Swipe up, down, left or right.
The selection on the display will then move in the respective direction.

Selecting items on the touchscreen

- Tap on a menu, an option or an application with one finger.
The menu, the option or the application is launched.

Controlling media playback on the touchscreen

- ▶ Swipe to the left.
The next media item is played or displayed, e.g. the next track or station.
- ▶ Swipe to the right.
Playback is restarted or the previous media item is played or displayed, e.g. the previous track.

Media playback can be controlled in the following playback modes:

- Radio mode
- Music and audio playback
- Image playback
- Video playback

Calling up menus

- ▶ Select **Menu** on the home screen.
- ▶ Select one of the following submenus.

Submenus:

- **Multimedia**
Radio and media playback
- **Navigation**
Navigation system
- **Telephone**
Mobile phone functions
- **Vehicle**
Reversing camera, eco score, energy flow and consumption details
- **Services**
TomTom Services
- **System**
General system settings

Confirming settings

- ▶ Select **Done**.
Settings are accepted.

Switching off the display

- ▶ Select home page >  > **Switch off screen**.

Adjusting the system settings

Adjusting the display

Setting the daytime brightness

- ▶ Select **System** > **Display**.
- ▶ Move the **Daytime brightness** control to the left or right.

Setting the night time brightness

- ▶ Select **System** > **Display**.
- ▶ Move the **Nighttime brightness** control to the left or right.

Activating automatic switching between day and night mode

- ▶ Select **System** > **Display** > **Automatic day/night mode**.

Displaying day mode constantly

- ▶ Select **System** > **Display**.
- ▶ Remove the tick for **Automatic day/night mode** and **Force night mode**.

Displaying night mode constantly

- ▶ Select **System** > **Display** > **Force night mode**.

Setting the system language

- ▶ Select **System** > **Language**.
A list of available languages is displayed.
- ▶ Select the desired language.

i The language of the spoken navigation announcement can be selected independently of the system language.

Changing the on-screen keyboard

- ▶ Select **System** > **Keyboards**.
- ▶ Select the keyboard layout.
The following keyboard layouts can be selected:
 - **Latin**
 - **Greek**
 - **Cyrillic**

For the **Latin** keyboard layout, it is possible to choose between the **ABCD**, **QWERTY**, **AZERTY** and **QWERTZ** layouts.

Selecting the home screen display

Different displays are available for the home page which display up-to-date information about the applications in the smart Media-System.

- ▶ Select **System > Home page**.
A selection of home screen displays appears.
- ▶ Select the desired display.

Resetting to factory settings

- ▶ Select **System > Restore factory settings**.
- ▶ Confirm with **Yes**.
All settings changed in the system return to the default values. All destinations, routes and favourites will be deleted.

Setting the time manually

- ▶ Select **System > Clock > Set time**.
- ▶ Change the minutes and hours of the time shown.

Activating automatic time adjustment

- ▶ Select **System > Clock > Set time > Automatic time adjustment**.

Setting the time format

- ▶ Select **System > Clock > Time format**.
- ▶ Select the time format.
The following time formats can be selected:
 - **18:00**
 - **6:00 PM**
 - **6:00**

Displaying status and information

- ▶ Select **System > Status & Information**.
- ▶ Select the information.
The following information can be selected:
 - **Version information**
Software and hardware of the Media-System
 - **GPS status**

Current GPS signal strength

- **Network status**
Signal strength of the data connection
- **Licences**
For free and open-source software used
- **Copyright**
For text in the TomTom software used.

Adjusting the audio settings

Setting the volume

- ▶ Select **System > Sound > Sound levels**.
- ▶ Select the volume setting.
The following volume settings can be selected:
 - **Main volume**
For the whole system
 - **Hands-free**
For the hands-free system
 - **Ringtone**
Ring tone volume
 - **Navigation**
Volume for the whole navigation system
 - **Computer voice**
Volume of the computer-generated voice
 - **App events**
Volume of events triggered by apps
- ▶ Set the desired volume.

Adjusting the volume to the vehicle speed (vehicles without JBL sound system)

The speed-dependent volume adjustment function adapts the volume to the current vehicle speed.

- ▶ Select **System > Sound > Speed sensitivity volume**.
- ▶ Move the **Speed dependency** control to the left or right.
The higher the value, the more the volume increases with the speed of the vehicle.

Volume adjustment is not set using the control but automatically.

Adjusting surround sound (balance)

- ▶ Select **Multimedia** > **Settings** > **Sound** > **Balance** > **Manual**.
- ▶ Move the control to the desired position.
- ▶ **Fade**: adjusts the surround sound (balance) to the front or back.
- ▶ Confirm with **Done**.

Adjusting the bass and treble

- ▶ Select **Multimedia** > **Settings** > **Sound** > **Bass/Treble** > **Manual**.
- ▶ Use the control to adjust the bass and treble separately.

Setting a neutral sound for the bass and treble

- ▶ Select **Multimedia** > **Settings** > **Sound** > **Bass/Treble** > **Neutral**.
Audio is played without increasing the bass or treble.

Activating and deactivating arkamys® bass boost (vehicles without JBL sound system)

The arkamys® bass boost setting emphasises the bass during playback.

- ▶ Select **Multimedia** > **Settings** > **Bass boost Arkamys**.

Manual activation of arkamys® bass boost on models with a JBL sound system is not possible. Activation functions automatically.

Setting the volume for warning tones

- ▶ Select **System** > **Sound** > **Alerts**.
- ▶ Move the control to the left or right.

Enabling warning tones when the display is switched off

- ▶ Select **System** > **Sound** > **Alerts** > **Keep audio alerts when screen turned off**.

Creating and deleting favourites

Creating favourites



- ① Preset
- ② Navigation
- ③ Radio
- ④ Telephone
- ⑤ Services
- ⑥ Context menu

Frequently used settings such as phone contacts and radio stations can be stored as favourites. Six favourites can be stored for each of the following categories:

- Navigation
 - Radio
 - Telephone
 - Services
- ▶ Select **Favourites** on the home screen.
 - ▶ Select a category.
 - ▶ Select the next empty memory position.
A list of possible favourites appears.
 - ▶ Select favourites.

Deleting favourites

- ▶ Select **Favourites** on the home screen.
- ▶ Select **[+]** > **Remove a Favourite**.
- ▶ Delete a favourite.

The following options can be selected:

- Select the favourite you wish to delete and confirm with **Delete**.
- To delete all favourites, select **Remove all Favourites**.

Listening to the radio

Switching on the radio

- ▶ Select **Multimedia** > **Radio**.

Display modes

Useful information

In radio mode there are three different display modes, in which various settings can be made:

- "List" display mode (FM and digital radio)
- "Frequency" display mode (AM and FM radio)
- "Presets" display mode

"List" display mode (FM and digital radio)



- ① Selects the waveband (AM/FM/DAB radio) and preset group (FM/DAB)
- ② Selects the previous station
- ③ Selects the next station
- ④ Context menu
- ⑤ "Frequency" display mode
- ⑥ "List" display mode
- ⑦ "Presets" display mode
- ⑧ Station currently playing

"Frequency" display mode (AM and FM radio)



- ① Selects the waveband (AM/FM radio) and preset group (FM)
- ② Increases or decreases the frequency in small increments
- ③ Station search, forwards or backwards
- ④ Context menu
- ⑤ Adjusts the frequency manually
- ⑥ Station currently playing

"Presets" display mode



- ① Selects the waveband (AM/FM/DAB radio) and preset group (FM/DAB)
- ② Stored station
- ③ Context menu
- ④ Station currently playing

Selecting a station

"List" display mode

- ▶ Swipe up or down in the station list.
- ▶ Tap on the desired station.

"Frequency" display mode (AM and FM radio)

- ▶ Slide control on the waveband left or right.

Starting a station search

- ▶ Select  or  in the "Frequency" display mode.

Storing a station

- ▶ Set the station.
- ▶ Select  > **Save as preset**.

Up to six stations can be stored for each waveband.

Displaying radio text

Radio text contains information such as current track or latest news.

- ▶ Select  > **Show radio text**.

Displaying digital radio services

- ▶ Select  > **DR services**.
- ▶ Select one of the following digital radio services:
 - **EPG** (Electronic Programme Guide)
Programme schedule for the station currently playing
 - **Intellitext**
Programme information and programme schedule for the station currently playing
 - **Slide show**
Displays images to accompany the current broadcast

Other radio settings

Searching for alternative frequencies with the best possible reception quality

- ▶ Select **Multimedia > Settings > Radio > AF (Alternative frequency)**.

Receiving traffic reports (i-Traffic)

- ▶ Select **Multimedia > Settings > Radio > i-Traffic (Traffic program)**.

Displaying the programme type (e.g. classical)

- ▶ Select **Multimedia > Settings > Radio > PTY (Program type)**.

Switching to the corresponding FM station when digital radio reception is poor

- ▶ Select **Multimedia > Settings > Radio > Simulcast**.

Displaying information on certain categories (i-Announcement, digital radio only)

- ▶ Select **Multimedia > Settings > Radio > i-Announcement**.
- ▶ Select an i-Announcements category.

Updating the station list

- ▶ Select **Multimedia > Settings > Radio > Update radio list**.

Displaying energy consumption

Calling up the energy flow display

- ▶ Select **Menu > Vehicle > Energy consumption > Energy flow**.

The **Energy flow** display shows the flow of energy in the vehicle.

The colour of the energy flow indicates the following:

- Green colouring: energy is being recuperated
- Orange colouring: the drive is consuming energy
- Yellow colouring and an illustration of the consumers: electrical consumers are consuming energy
- Grey colouring: no energy is being recuperated or consumed

Calling up the detailed consumption display

- ▶ Select **Menu** > **Vehicle** > **Energy consumption** > **Consumption details**.

The **Consumption details** display shows the energy consumption of the drive and electrical consumers as well as the energy recuperated during the previous 15 minutes. The display also shows the total consumption of the drive and electrical consumers as well as the total amount of energy recuperated during the current journey.

The **Consumption details** display is reset each time the engine is switched on.

Using a mobile phone

Connecting a mobile phone

Please note

WARNING

The electromagnetic radiation from two-way radios can interfere with the vehicle electronics if they are manipulated or retrofitted incorrectly. This could jeopardise the operating safety of the vehicle. There is a risk of an accident.

You should have all work on electrical and electronic components carried out at a qualified specialist workshop.

WARNING

If you operate two-way radios incorrectly in the vehicle, their electromagnetic radiation can interfere with the vehicle electronics, for example if:

- the two-way radio is not connected to an exterior aerial
- the exterior aerial is not correctly mounted or is not low-reflection

This could jeopardise the operating safety of the vehicle. There is a risk of an accident. Have the low-reflection exterior aerial fitted at a qualified specialist workshop. When operating two-way radios in the

vehicle, always connect them to the low-reflection exterior aerial.

Bluetooth® must be enabled both on the mobile phone and on the smart Media-System.

Enabling and disabling Bluetooth®

The mobile phone must be compatible with the smart Media-System.

Overview of compatible mobile phones: <https://www.smart.com/connect>.

- ▶ Select **Settings** > **Turn Bluetooth on**.
The setting is marked. Bluetooth® is enabled or disabled on the smart Media-System.

Authorising a mobile phone

Authorising a mobile phone for the first time

Bluetooth® must be enabled on the smart Media-System.

- ▶ Select **Phone** menu.
- ▶ Confirm the display message with **Yes**.
- ▶ Enter the security code on the mobile phone or accept access confirmation (see manufacturer's operating instructions). The **Enabling Bluetooth** message appears.

Authorising another mobile phone

Bluetooth® must be enabled on the smart Media-System.

- ▶ Select **Settings** > **Manage devices**.
The list of visible mobile phones appears.
- ▶ Select the mobile phone from the list.
- ▶ Enter the security code on the mobile phone or accept access confirmation (see manufacturer's operating instructions). The Bluetooth® connection is established. The Bluetooth® connection will be established automatically in future.

Downloading telephone data automatically

- ▶ Select **Settings > Automatically download phone data.**
- ▶ If necessary, accept the access confirmation on the mobile phone.
During connection, up to 1,000 contacts are automatically transferred to the smart Media-System.

Connecting another authorised mobile phone

- ▶ Select **Settings > Manage devices.**
- ▶ Select the mobile phone.
The current Bluetooth® connection is terminated. The desired mobile phone is connected to the smart Media-System instead.

Removing a mobile phone from the list

- ▶ Select **Settings > Manage devices.**
- ▶ Select **[+] > Delete device(s).**
- ▶ Select the mobile phone.
- ▶ Select **Delete.**

Terminating a Bluetooth® connection

- ▶ Select **Settings > Manage devices.**
- ▶ Select **[+] > Disconnect all devices.**
- ▶ Select the mobile phone.

If the mobile phone leaves the Bluetooth® receiver range, the connection is automatically terminated.

Telephone operation

Useful information

The following conditions must be fulfilled in order to make a **999** or **112** emergency call:

- a valid and operational SIM card is inserted in the mobile phone
- a mobile phone network is available

Calling a contact from the phone book

- ▶ Select **Phonebook.**
- ▶ Select the contact.
- ▶ Select the contact's telephone number.

If the phone book contains multiple contacts, they can be called up using **Find.**

Dialling a phone number

- ▶ Select **Dial a number.**
- ▶ Enter a number on the keypad.
- ▶ Select **Call.**

Calling a contact from the call log

- ▶ Select **Call logs.**
- ▶ Select an entry from the list.

The call log can be sorted according to calls made, calls received and missed calls using the corresponding receiver icon.

Accepting and rejecting an incoming call

If a call is incoming, the following information will appear on the display:

- name of caller, if already in the phone book
- number of caller, if name of caller is not already in the phone book
- **Private number**, if the caller has the "Hide caller ID" function switched on
- ▶ To accept the call, select **Pick up.**
- ▶ To reject the call, select **Refuse.**
The call will be forwarded to voicemail.

Holding and continuing a call

- ▶ Select **[+] > Put on hold.**
- ▶ To continue the call, select **Resume.**

Transferring a call to the mobile phone

- ▶ Select **[+] > Handset.**

Ending a call

- ▶ Select **End call.**

Using the smartphone screen application

Selecting settings for the smartphone screen

Selecting the preferred smartphone screen application

If mobile phones support Android Auto™ as well as MirrorLink®, the preferred application can be selected when a mobile phone is connected.

- ▶ Select **System > Smartphone Screen > Smartphone Screen application preference.**
- ▶ Select Android Auto™ or MirrorLink®.

Selecting settings to start Android Auto™ and MirrorLink®

- ▶ Select **System > Smartphone Screen > Android Auto™ Settings.**
- or
- ▶ Select **System > Smartphone Screen > MirrorLink™ Settings.**
- ▶ Select one of the following settings:
 - **Ask me at each launch**

If the smartphone has been connected with the smart Media-System, you will be asked whether the preferred smartphone screen application should be started.

- **Yes**

If the smartphone has been connected with the smart Media-System, the preferred smartphone screen application will be started automatically.

- **No**

If the smartphone has been connected with the smart Media-System, a smartphone screen application will not be started.

Using MirrorLink®

Useful information

MirrorLink® is a standard for the connection between the smart Media-System and a mobile phone. With MirrorLink®, the content of the display on your mobile phone can be displayed in the smart Media-System.

MirrorLink® is available for mobile phones with the Android™ operating system.

Further information: <http://www.smart.com/connect>.



To use MirrorLink®, observe the following requirements:

- the mobile phone must support MirrorLink® version 1.1 and above
- the mobile phone is switched on
- a MirrorLink® certified app must be installed on the mobile phone
- the GPS connection must be activated on the mobile phone
- the time is set on the smart Media-System

Setting up a connection



- ▶ Activate MirrorLink® on your mobile phone (see the manufacturer's operating instructions).
- ▶ Connect a mobile phone with a connecting cable to the USB socket in the centre console.
- ▶ Select **Yes.**
Apps which have been certified for MirrorLink® will be shown in the smart Media-System display.



Calling up MirrorLink® apps

- ▶ Tap  on the home page of the smart Media-System.
MirrorLink® starts in the smart Media-System display.
- ▶ Select the desired app.
The display switches to full screen mode.
- ▶ **To leave full screen display:** press and hold the  button on the smart Media-System until the lower bar is shown.
- ▶ **To leave the display:** select .

MirrorLink® audio playback

If your mobile phone supports this function, you can control audio playback via the buttons on the smart Media-System.

- ▶ **To select the previous track:** press the  button.
- ▶ **To rewind:** press and hold the  button.
- ▶ **To select the next track:** press the  button.

- ▶ **To fast forward:** press and hold the  button.
- ▶ **To mute:** press the  button.

Terminating a MirrorLink® connection

- ▶ Select  > **Disconnect**.

Using Android Auto™

Useful information

Android Auto™ is an application for the connection between the smart Media-System and a mobile phone. Certain mobile phone functions and apps can be controlled via the smart Media-System with Android Auto™.

Functions such as telephony, navigation and the audio playback of Android Auto™ are displayed on the home page of the smart Media-System.

Android Auto™ is available for mobile phones with the Android™ operating system.

Further information: <http://www.smart.com/connect>.

In order to use Android Auto™, the following conditions must be met:

- the mobile phone supports Android Auto™ starting from Android™ 5.0
- the mobile phone is switched on
- the mobile phone has an Internet connection
- the Android Auto™ app is installed on the mobile phone
- data sharing must be approved

Transmitted vehicle data when using Android Auto™

When using Android Auto™, specific vehicle data is transmitted to the mobile phone. This makes it possible to use selected mobile phone services efficiently. The mobile phone does not have active access to vehicle data. The following system information is transmitted:

- smart Media-System software status
- system ID (anonymous)

This data is transmitted in order to optimise communication between the vehicle and mobile phone.

A random vehicle code is generated for this purpose and in order to assign multiple vehi-

cles to the mobile phone. This code is not related to the vehicle identification number (VIN) and is deleted if the smart Media-System is reset.

The following driving status data is transmitted:

- gear position engaged
- instrument cluster day/night mode

This data is transmitted in order to adapt the content displayed to the driving situation.

GPS data such as coordinates, speed and compass direction is transmitted. This data is transmitted only when navigation is active in order to improve navigation (e.g. when driving through a tunnel).

Setting up a connection

- ▶ Activate Android Auto™ on the mobile phone (see manufacturer's operating instructions).
- ▶ Connect a mobile phone with a connecting cable to the USB socket in the centre console.
- ▶ Select **Yes**.
Android Auto™ starts in the smart Media-System display.

Calling up Android Auto™

- ▶ Tap  on the home page of the smart Media-System.
Android Auto™ starts in the smart Media-System display.

Activating Android Auto™ voice-operated control

When Android Auto™ is activated, the system can be operated with voice control.

- ▶ Press and hold the  button on the multifunction steering wheel for approximately three seconds.
A tone sounds.

Disconnecting Android Auto™

- ▶ Disconnect the USB connection between the mobile phone and the smart Media-System.

Using voice control for the mobile phone

Useful information

The voice control of the connected mobile phone can be used (see manufacturer's operating instructions). Not all voice control services are supported by the smart Media-System.

The requirement for voice control of the mobile phone is that Android Auto™ or MirrorLink® are not active.

Activating voice control for the mobile phone

- ▶ Connect the mobile phone with the smart Media-System via Bluetooth®.
- ▶ Press and hold the  button on the steering wheel.

The  symbol appears in the display. Voice control for the mobile phone is active.

Further settings

Setting the volume

- ▶ Select **Settings** > **Sound levels**.
- ▶ Set the volume of the hands-free system and the ringtone.

Activating voicemail

- ▶ Select **Voice mail**.
- ▶ Enter the voicemail phone number on the keypad.
- ▶ Select **Done**.
Voicemail is activated and the voicemail number is dialled.

Configuring voicemail

- ▶ Select **Settings** > **Voice mail configuration**.

Updating the phone book

A Bluetooth® connection must be present.

- ▶ Select **Phone book** >  > **Update phone data**.

Updating the call log

- ▶ Select **Call logs** >  > **Update phone data**.

Adding a contact to favourites

- ▶ Select **Phone** > **Phonebook**.
- ▶ Select the contact from the list.
- ▶ Select  > **Add to Favourites**.
- ▶ Dial a phone number.

Connecting and operating external data storage media

Useful information

The following external data storage media can be connected:

- USB memory stick (USB 2.0 or 3.0 with max. 64 GB) or iPod™
 - SD or SDHC card (max. 64 GB)
 - External audio equipment (AUX connection)
 - Bluetooth® devices such as mobile phones
- The following formats are supported:

- MP3 files
- WMA files
- ACC formats (.AAC, .M4A, .M4B, .M4P, .M4V, .M4R, .MP4 and .3GP)
- OGG Vorbis (.OGG, .OGA)
- PCM 16 bit (.WAV, .PCM)

A data storage medium may contain no more than eight directory levels.

The smart Media-System only recognises the first partition of a data storage medium. The partition must be formatted as FAT or FAT32.

Connecting external data storage media

Connecting a USB memory stick

- ▶ Insert a USB memory stick in the port on the centre console.
Playback starts automatically.

Connecting an SD card

- ▶ Insert an SD card into the SD card slot in the centre console.
Playback starts automatically.

Connecting a Bluetooth® device

- ▶ Authorise and connect a Bluetooth® device, such as a Bluetooth®-capable mobile phone.

Operating external data storage media

Selecting connected external data storage media

- ▶ Select **Menu** > **Multimedia** > **Media**.
- ▶ Select connected medium.

Controlling playback from a USB memory stick or SD card



- ① Selects the previous track
- ② Selects the next track
- ③ Stops and continues playback
- ④ Switches track repeat on
- ⑤ Switches random playback on
- ⑥ Calls up the context menu
- ⑦ Displays the playlist

- ⑧ Selects a new track based on categories, e.g. album, genre, folder
- ⑨ Resumes playback at any point in the track

Controlling playback from a Bluetooth® device



- ① Selects a new track
- ② Selects the previous track
- ③ Stops playback
- ④ Selects the next track
- ⑤ Displays the playlist
- ⑥ Calls up the context menu

Selecting a different device

- ▶ Select **[+]** > **Change source**.

Connecting another authorised Bluetooth® device

- ▶ Select **[+]** > **Find new device**.

Enabling and disabling random playback

- ▶ To enable: select **[+]** > **Enable shuffle**.
- ▶ To disable: select **[+]** > **Disable shuffle**.

Displaying details of tracks on a USB memory stick or SD card

- ▶ Select **[+]** > **Song details**.

Selecting a track from current playlist

- ▶ Select **New selection** > **Folders**.
The current playlist is displayed.
- ▶ Select **Find**.
A keyboard is shown.
- ▶ Enter the name or part of the name of the track you are looking for.

Selecting a track from categories

- ▶ Select **New selection**.
- ▶ Select a category for playback.

Switching album cover display on and off

The album cover must be saved in the audio file.

- ▶ Select **Multimedia** > **Settings** > **Media** > **Display album cover**.

Viewing images

Useful information

Images that have been saved to an SD card or USB memory stick can be viewed in the smart Media-System.

The following file formats can be displayed:

- .JPG
- .GIF
- .PNG
- .BMP

Image playback

Starting image playback

- ▶ Insert an SD card or USB memory stick into the corresponding port.
- ▶ Select **Multimedia** > **Pictures**.
- ▶ Select **USB** or **SD** as the media source.
- ▶ Select a folder.
- ▶ Select an image.

Switching between images

- ▶ Swipe left or right.

Specifying a new selection of images

- ▶ Select **New selection**.

Setting image playback

Switching from normal to thumbnail view

- ▶ Select **Thumbnails**.

Switching from thumbnail to normal view

- ▶ Select an image.

Displaying in full screen mode

- ▶ Select  > **Full screen**.

Activating the controls in full screen mode

- ▶ Tap the touchscreen.

Switching from full screen mode to normal view

- ▶ Select  > **Normal view**.

Enlarging the image

- ▶ Select  > **Zoom in**.

Showing images as a slide show

- ▶ Select  > **Slide show**.

Setting the display duration

- ▶ Select  > **Picture settings** > **Slide show delay**.
- ▶ Set the desired time using the controls.

Setting default view for image playback

- ▶ Select  > **Image settings** > **Default view**.
- ▶ Select **Normal view** or **Full screen**.

Video playback

Video playback

Starting video playback

- ▶ Insert an SD card or connect a USB stick.
- ▶ Select **Multimedia** > **Video**.
- ▶ Select **USB** or **SD**.
- ▶ Select a folder or video.
All videos in a folder are played one after the other.

- i The size of the video file may have an impact on the performance of the system. Therefore, only playback videos with a length of up to five minutes.

Selecting the next or previous video

- ▶ Select  or .

Stopping and continuing playback

- ▶ Select .

Playing a new video

- ▶ Select **New selection**.
- ▶ Select a new video.

Setting the video view

Playing videos in full screen mode

- ▶ Select **Full screen**.

Setting the default view for video playback

- ▶ Select  > **Video settings**.
- ▶ Select **Normal view** or **Full screen**.

Using TomTom Services

Please note

The smart Media-System uses a mobile phone connection for data connection.

Please take note of the following information when using data services:

- The mobile connectivity and built-in SIM card for this vehicle can only be used for data services. These are offered by certain third parties as well as Daimler AG. Usage occurs via the smart Media-System in the vehicle. The use of data services requires the conclusion of separate agreements between the vehicle user and the respective provider. Voice service usage is not permitted. As such, the SIM card must be permanently installed in the condition in which it was delivered.
- The mobile communications connectivity and the SIM card may only be used responsibly in accordance with the applicable laws and other legal requirements of the corresponding countries. Provided that this is within the power of the vehicle user.
- Upgrading, reproduction, reverse assembly and disassembly of the SIM card are not permitted. Statutory authority remains unaffected.

Failure to follow the above instructions can, in some cases, lead to temporary or permanent deactivation of the mobile connection and the SIM card. This depends on the severity of non-observance. The measure described here contributes in particular to the protection of Daimler AG and its contractual partners from negative legal consequences due to non-observance. The availability of mobile connectivity in individual countries depends on the existence of corresponding mobile service agreements with local mobile network providers. Availability can therefore change from time to time. The maximum period of validity for the mobile connectivity is 15 years from the time of installation in the vehicle.

Useful information

In the **TomTom Services** menu, traffic information and other TomTom Services can be called up and managed.

TomTom Live Services are available for a subscription fee. The following TomTom Services come pre-installed and, following activation, can be used free of charge for a period of three years:

- HD Traffic
- Radar cameras (not available in all countries)
- Weather
- TomTom Places

More information on services
<http://www.tomtom.com/services>.

More information on availability in specific countries: <http://smart.com/connect>

TomTom Services can also be called up and managed in the **Services** menu. In the main menu, select **Services > TomTom Services**.

- i** If you have subscribed to the "TomTom Traffic" service and this is available, the "Traffic info" menu will be called "TomTom Traffic".

Activating TomTom Services

TomTom Services must be activated in the smart Media-System before using them for the first time. If TomTom Services are not yet activated, a corresponding button will be displayed in the main menu and in the **Services** menu.

To activate TomTom Services for the first time, observe the following requirements:

- an SD card with map data is inserted into the SD card slot
 - a valid vehicle position is available on the map
 - a mobile phone network is available
- ▶ Select **Services > Activate My Services**.
- ▶ Confirm the display messages with **Yes**. After a short while, TomTom Services are available.
- ▶ Select **Services > TomTom Services**. The TomTom Services installed on the device are displayed.
- ▶ Select the desired TomTom service. A display message appears. TomTom Services are activated.

Starting TomTom Services

- ▶ Select **Navigation > TomTom Services**.

Checking subscription status for TomTom Services

The services available on the device and their subscription status may be checked at any time.

- ▶ Select **Services > TomTom Services > My services**.

The services available on the device and their subscription status will be shown.

Subscription to a service can be extended via <http://www.tomtom.com>, subject to a fee. This requires registration at <http://tomtom.com/forsmart>.

- ▶ Remove the SD card from the vehicle and insert it into a computer.

Further information: <http://tomtom.com/forsmart>.

Downloading updates and POIs

If available, map and software updates as well as points of interest may be downloaded via <http://www.tomtom.com>. This requires registration at <http://tomtom.com/forsmart>.

- ▶ Remove the SD card from the vehicle and insert it into a computer.

Further information: <http://tomtom.com/forsmart>.

Calling up Applications manager

Information on smartphone screen applications and smartphone voice-operated control can be called up with the Applications manager.

- ▶ Select **Services > Settings > Applications manager**.

Calling up the connectivity manager

The connectivity manager allows you to manage the devices connected to the smart Media-System.

- ▶ Select **Services > Settings > Connectivity manager**.

Managing data sharing

Please note

If data sharing is approved, smartphone screen applications, for example Android Auto™, smartphone voice-operated control and the online charging station search are activated alongside TomTom Services.

Enabling or disabling data sharing

If data sharing has not been enabled beforehand, a corresponding message is shown when the smart Media-System is started up. Data sharing can be enabled or disabled at any time.

- ▶ Select **Services > Settings > Data sharing**.
- ▶ Select one of the following settings:
 - **Yes**
Enable data sharing
 - **No**
Disable data sharing.

Displaying additional information

- ▶ Select **Services > Settings > Data sharing > About**.

Displaying text in another language

- ▶ Select **Services > Settings > Data sharing > Language**.

Using the navigation system

Starting the navigation system

Please note

WARNING

If you operate information and communication equipment integrated in the vehicle when driving, you could be distracted from the traffic situation. This could also cause

you to lose control of the vehicle. There is a risk of an accident.

Only operate this equipment when the traffic situation permits. If you cannot be sure of this, stop the vehicle paying attention to road and traffic conditions and operate the equipment with the vehicle stationary.

The navigation system does not provide information on stop signs, right of way signs, traffic regulations or road safety regulations.

The traffic regulations always take precedence over navigation announcements. Observe the legal stipulations and traffic regulations of the country you are driving in when in navigation mode.

Selecting the navigation system

- ▶ Select **Menu > Navigation**.
The following functions can be carried out:
 - searching for a destination
 - planning a route
 - displaying a map
 - calling up TomTom Services
 - changing navigation settings

Installing map data

WARNING

SD cards are small parts. They can be swallowed and cause choking. This poses an increased risk of injury or even fatal injury.

Keep the SD card out of the reach of children. If a SD card is swallowed, seek medical attention immediately.

- ❗ To prevent damage to data, only use the SD card provided for the data in the Media-System or for updating map and systems files.
- ▶ Insert an SD card into the SD card slot in the centre console.
- ▶ Switch on the device.
The map data is read by the navigation system.

Removing an SD card

- ▶ Select **Menu** > **System** > **Remove SD-card**.
- ▶ Confirm the display message with **Yes**.
- ▶ Press the SD card.
- ▶ Remove the SD card from the slot.

Updating map data

Regular updates will be offered for the map data. The first update can be downloaded for free in the web portal within 90 days of vehicle activation. This requires registration at <http://tomtom.com/forsmart>. Further information is available from any smart centre.

- ▶ Remove the SD card from the vehicle and insert it into a computer.
- ▶ Install update software on the computer.
- ▶ Run the map update assistant.

i As well as updates, the latest software for the Media-System can be downloaded and Premium Voices by TomTom can be purchased.

Entering and managing destinations

Entering a destination by address

- ▶ When using the navigation system for the first time, enter the country.
- ▶ Select **Navigation** > **Drive to...** > **Address**.
- ▶ If desired, change the country using the flag symbol.
- ▶ Enter the town or postcode.
- ▶ Select the destination from the list.
- ▶ Select the street.
- ▶ Select the house number.
- ▶ Confirm with **Done**.

Searching for a car park near the destination address

This function can be called up when entering the destination.

- ▶ Select **[+]** > **Nearby car park**.
A list of car parks near the current destination appears.

Displaying information about the destination address

This function can be called up when entering the destination.

- ▶ Select **[+]** > **Show info**.

Entering a destination using the map

A location on the map can be selected as the destination.

- ▶ Select **Navigation** > **Drive to...** > **Point on map**.
- ▶ Align the map view with the destination.
- ▶ Tap the destination point on the display. The symbol selected is highlighted in blue.
- ▶ Tap on the symbol to confirm.

Entering a destination using the voice control system

- ▶ Press the  button on the multifunction steering wheel.
A tone sounds.
- ▶ Say the command "Enter address".
- ▶ When prompted by the voice control system, say the destination address, including street name, house number and city.
- ▶ Say the voice command "Yes" or, if several possible destinations are displayed, say the number.

Selecting a destination from the list of previous destinations

- ▶ Select **Navigation** > **Drive to...** > **Recent destinations**.
- ▶ Select the destination.

Entering a destination using geo-coordinates

- ▶ Select **Navigation** > **Drive to...** > **Latitude Longitude**.
- ▶ Enter the longitude and latitude.

- ▶ Select **[+]** > **Nearby car park**.

A list of car parks near the current destination appears.

Setting a home location

- ▶ Select **Navigation > Settings > Set home location**.
- ▶ Enter a home address.

Setting home as a destination

- ▶ Select **Navigation > Drive to... > Home**.

Selecting a saved location as a destination

At least one destination must be stored for this function.

- ▶ Select **Navigation > Drive to... > Saved locations**.
- ▶ Select the destination.

Managing saved locations

- ▶ Select **Navigation > Settings > Manage saved locations**.

Entering a charging station as a destination

- ▶ Select **Navigation > Drive to... > Charging stations**.

The following list of locations appears in which a charging station can be searched for:

- **Near my location**
- **Along route**
- **Near destination**
- **Near Home**
- **In city**
- ▶ Select the location for the charging station search.
A list of the corresponding charging stations appears. There is an automatic check whether a charging point is free on these charging stations. The check may take several minutes. When the check is finished, a message appears. If a charging station has a charging point which is not being used, it will be marked green. If no charging point is free, or no information is available, the charging station is marked grey. Charging stations from the map data which cannot be checked are not marked. A

maximum of 24 charging stations can be checked.

- i** Five minutes after the check, the marking automatically changes from green to grey.
- ▶ Select a charging station.

Entering a point of interest

POIs such as museums, restaurants or car parks near a location are displayed on the map.

- ▶ Select **Navigation > Drive to... > Point of interest**.

The following list of surrounding areas appears. A POI can be searched for in these areas:

- **Near my location**
- **Along route**
- **Near destination**
- **Near Home**
- **In city**
- ▶ Select the surrounding area in which to search for a POI.
The following list of categories for POIs appears:
 - list of categories for POIs: e.g. charging station or restaurant
 - POI name search
 - POI search within a category
- ▶ Select the category for the search.
- ▶ Select a POI.

- i** If the charging station category is selected, only charging stations from the map data are searched. Charging stations that can be checked for charging point availability are not taken into account.

Managing POIs

Adding a POI category

- ▶ Select **Navigation > Settings > Manage POIs > Add POI category**.
- ▶ Enter the name and symbol for the new POI category.

Deleting a POI category

- ▶ Delete **Navigation > Settings > Manage POIs > Delete POI category**.
- ▶ Select the category to be deleted.

Adding POIs

- ▶ Select **Navigation > Settings > Manage POIs > Add POI**.
If no POI categories have been defined yet, a prompt appears to enter a POI category.
- ▶ Select the category for the POI.
- ▶ Enter your POI.

Having POIs displayed on map

This function enables the display of personalised POIs on the map.

- ▶ Select **Navigation > Settings > Show POI on map**.

Deleting POIs

- ▶ Select **Navigation > Settings > Manage POIs > Delete POI**.
- ▶ Select a POI category.
- ▶ Select the POI to be deleted.

Editing POIs

- ▶ Select **Navigation > Settings > Manage POIs > Edit POI**.
- ▶ Select a POI category.
- ▶ Customise the POI properties.

Setting alerts for a nearby POI

- ▶ Select **Navigation > Settings > Manage POIs > Warning when near POI**.
- ▶ Select a POI category.
- ▶ Set the distance at which the message should appear.
- ▶ Set the type of alert issued.

Entering a destination via the TomTom LIVE service "TomTom Places"

POIs from the "TomTom Places" online database are available using the "TomTom Places" function.

- ▶ Select **Navigation > Drive to... > TomTom Places**.
A list of search criteria appears which can be used to search for a POI.
- ▶ Select the search criterion.
- ▶ Enter a search term.
If a large number of search results are available, 20 additional search results can be downloaded.

Changing the route

Useful information

Once the destination has been selected, the navigation system calculates the route to the destination. The following options are available for adjusting route guidance:

- calculate alternative routes
- adjust routes calculated by the navigation system
- plan routes in advance and travel via specific way points
- adjust settings for calculating routes

Once the route is calculated, a route summary is shown. By default, the quickest route will be calculated for route planning, taking into account IQ Routes™. Traffic information is taken into account when calculating the route.

Depending on the remaining range, sections of the route receive the following colours:

- green: remaining range is expected to be sufficient for the route.
- orange: this route may or may not be able to be completed depending on the driving style and the influence of external factors.
- red: remaining range is not expected to be sufficient for the route.

The "route overview" function allows you to set whether the summary of a calculated route is automatically faded out from the display after ten seconds.



If the route is not confirmed with **Done**, the view switches after approximately ten seconds automatically to the map view.

Displaying a planned route

Calculating the route

- ▶ Enter a destination.
- ▶ Select **Done**.
The route is displayed. If the remaining range is not expected to be sufficient to reach the destination, a prompt will appear asking whether a charging station should be added to the route.

Displaying the route details

- ▶ Select  > **Route details**.
- ▶ Select one of the following functions:
 - **Show instructions**
An overview of the route with directions appears.
 - **Show map of route**
The route appears on a map.
 - **Show destination**
The destination for the route appears.
By pressing , it is possible to search for a car park near the destination or add the location to the saved locations.
 - **Show traffic on route**
Traffic disruptions along the route are shown.
 - **Summary**
A summary of the route details appears.

Saving a planned route

- ▶ Select  > **Save Itinerary**.

Changing the route

Cancelling the route

- ▶ Select **Navigation** > **Change route** > **Cancel route**.
When a new destination is entered, route guidance can be resumed again.

Calculating an alternative route

- ▶ Select **Navigation** > **Change route** > **Calculate alternative**.
A new route is calculated and displayed that takes you on different roads.
- ▶ Select the alternative route or a previous one.

Route guidance via way point

The route can be adjusted by entering up to four way points.

- ▶ Select **Navigation** > **Change route** > **Travel via**.
If a way point has already been entered, a list of the saved way points will be displayed.
- ▶ Select **Add**.
- ▶ Select a new way point from **Address**, **Recent destinations**, **Saved locations**, **TomTom Places** or **Point of interest**.
The new way point is added.

Avoiding road blocks

The route can be changed if a section of road along the route is blocked or there is a traffic jam.

- ▶ Select **Navigation** > **Change route** > **Avoid roadblock**.
- ▶ Select the length of the route that needs to be avoided.

Avoiding specific roads

The route is calculated to avoid specific roads.

- ▶ Select **Navigation** > **Change route** > **Avoid part of route**.
A list of the roads on the route is displayed.
- ▶ Select the street that you wish to avoid.

Taking traffic disruptions into account

The route is recalculated based on current traffic information.

- ▶ Traffic information is not available in all countries and regions.
- ▶ Select **Navigation** > **Change route** > **Minimise delays**.
An overview of the traffic disruptions along the route will be shown.
- ▶ Select the traffic disruption you wish to avoid.

Planning a route in advance

Adding a route

- ▶ Select **Navigation** > **Itineraries**.
- ▶ Select **Add**.
- ▶ Select the starting point of the route.
- ▶ Enter the route destination.
- ▶ Enter at least one way point for the route.

- ▶ Enter the route name.
- ▶ Confirm with **Done**.

Starting navigation using a saved route

- ▶ Select **Navigation > Itineraries**.
- ▶ Select the desired route.
- ▶ Select **[+]** > **Start**.

Setting route planning

Selecting route types

- ▶ Select **Navigation > Settings > Route planning > Route types**.
- ▶ Select one of the following settings:
 - **Ask for every route**
 - **Always plan the fastest route**
 - **Always plan eco routes**
 - **Always avoid motorways**
 - **Always plan the shortest route**

Selecting the setting for toll roads

- ▶ Select **Navigation > Settings > Route planning > Toll roads**.
- ▶ Select one of the following settings:
 - **Ask for toll roads on route**
 - **Always avoid toll roads**
 - **Do not avoid toll roads**

Selecting the setting for ferry connections

- ▶ Select **Navigation > Settings > Route planning > Ferry connections**.
- ▶ Select one of the following settings:
 - **Ask for ferries on my route**
 - **Always avoid ferries**
 - **Do not avoid ferries**
- i** Route planning treats the Eurotunnel as a ferry connection.

Selecting the setting for unpaved roads

- ▶ Select **Navigation > Settings > Route planning > Unpaved roads**.
- ▶ Select one of the following settings:
 - **Ask for unpaved roads on my route**
 - **Always avoid unpaved roads**

Selecting the setting for carpool lanes

Carpool lanes are lanes which can only be used by vehicles with at least two occupants.

- ▶ Select **Navigation > Settings > Route planning > Carpool lane settings**.
- ▶ Select one of the following settings:
 - **Ask for carpool lanes on my route**
 - **Always avoid carpool lanes**
 - **Never avoid carpool lanes**

Using information during route guidance

Useful information

Navigation announcements provide guidance during the journey without distracting you from traffic conditions. In addition, the display shows information about the route.

Switching navigation announcements on and off

- ▶ Tap on the area of the next navigation manoeuvre during route guidance.
- ▶ Select **Turn on voice guidance** or **Turn off voice guidance**.

Information such as traffic reports and warnings will be played even if the navigation announcements have been deactivated.

During route guidance, traffic information can be shown for the route ahead. The following traffic information can be received:

- Traffic announcements (RDS/TMC)
- HD Traffic (a TomTom Live service)
- i** HD Traffic Information takes precedence.

Live services are not available in all countries and regions. Further information: <http://tomtom.com/services>

Tracking navigation on the display

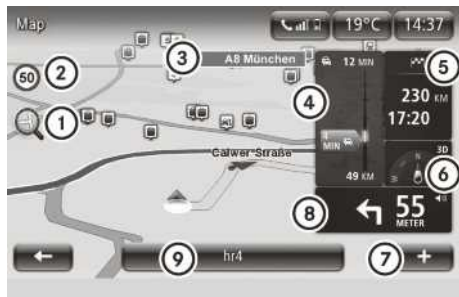

- ① Zoom in and out of the map view
- ② Maximum permitted speed
- ③ Name of the next main road or information about the next street sign
- ④ Traffic information
- ⑤ Route information
Warning for remaining range to destination
- ⑥ Compass and symbol for two or three-dimensional map display
- ⑦ Context menu
- ⑧ Next navigation manoeuvre with distance and symbol for volume adjustment
- ⑨ Information about current radio or audio equipment

► Tap on an area or on a symbol in the map display:

- Map: to switch to the overview map
- ①: to zoom in and out of the map view
- ④: to show traffic reports on the route
- ⑤: to display the route details
- ⑥: to switch between two or three-dimensional map display
- ⑦: to open the context menu
- ⑧: to repeat the navigation message, change the volume of navigation announcements or switch off
- ⑨: to switch to the corresponding radio, multimedia or telephone menu

The navigation system zooms in on the map view as the vehicle approaches a junction. This makes it possible to follow turning manoeuvres more accurately.

Shortly before navigating a motorway junction or exit, the display will show a three-dimensional representation of the lanes and

the exit. Lane Keeping Assist is not available for all junctions in all countries.

Traffic information details

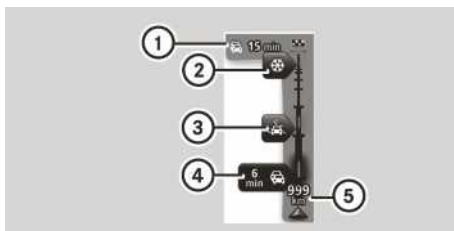

- ① Overall delay on route
- ② Traffic disruption (packed snow)
- ③ Traffic disruption (rain)
- ④ Traffic disruption (traffic jam)
- ⑤ Current location and distance to next traffic disruption

During route guidance, traffic information is shown for the route ahead. When there are a number of traffic disruptions in quick succession, only the very next disruption on the route will be displayed.

Traffic information is not available in all countries and regions.

Colour	Meaning
Grey	Unknown or unexplained situation
Orange	Slow-moving traffic
Red	Traffic jam
Dark red	Standstill or road blocked

Calling up more detailed information about the traffic problems

- Tap on the display for traffic information during route guidance.

Scrolling through the traffic reports

- Tap on the message on the touchscreen and swipe left or right.

Displaying the overview map

Useful information

With the "View map" function, the display shows a slidable, two-dimensional overview map. The map shows your current position, as well as a number of other elements, such as favourites.

Displaying a map

- ▶ Select **Navigation > View map**.
A map of the surrounding area will be shown.
- ▶ To search: select  > **Find**.

Controlling the map view

Moving the map

- ▶ Tap on the centre of the touchscreen.
- ▶ Swipe in the desired direction. The map will then move in the respective direction.

Zooming in on the map

- ▶ Place two fingers slightly apart in the middle of the touchscreen.
- ▶ Move your fingers away from each other.

Reducing the scale of the map

- ▶ Place two fingers at a greater distance apart on the screen. Do not place your fingers at the very top area or very bottom area of the display.
- ▶ Pull your fingers towards each other.

Displaying the reachability map

If no route is planned, a reachability map can be displayed in order to roughly gauge the range with the current charge status.

- ▶ Select **Navigation > View map**.
- ▶ Select  > **View reachability map**.

Showing and hiding additional information on the map

- ▶ Select **Navigation > View map**.
- ▶ Select  > **Change map information**.
- ▶ Select one of the following pieces of information:

- Traffic information
- Names
- Points of interest (POIs)
- Satellite images
- Coordinates

Using TomTom Services with the navigation system

Displaying traffic information along the route

- ▶ Tap on the area of traffic information during route guidance.
- ▶ Swipe left or right to switch between traffic information.





Adjusting the route according to traffic disruptions







- ▶ Select **Navigation > TomTom Services > Traffic > Minimise delays**.
A faster route that had been previously rejected or route which may not have been taken into account due to the **Never change my route** setting for the traffic information is selected.

Displaying traffic disruptions on the overview map

- ▶ Select  > **View map** during route guidance.
Traffic disruptions are displayed as symbols on the overview map. Large area traffic disruptions such as rain, fog or snow are displayed with several symbols.
- ▶ To view detailed information, tap on a traffic disruption symbol.

The following symbols are used:

Symbol	Meaning
	Traffic jam
	Road blocked
	Traffic disruption
	Construction site

Symbol	Meaning
	One or more lanes blocked
	Accident
	Traffic disruption avoided using the traffic information
	Fog
	Wind
	Snow
	Black ice
	Rain

- i** Large area traffic disruptions such as rain, fog or snow are displayed on the overview map with several symbols.

Viewing traffic information for the route to work

- ▶ Select **Navigation > TomTom Services > Traffic > Traffic info. for route to work.**
- ▶ Select one of the following settings:
 - Home to work
 - Work to home
 - Change the home to work route

Selecting the settings for traffic information

- ▶ Select **Navigation > TomTom Services > Traffic > Traffic info. settings.**
- ▶ Select one of the following settings:
 - **Always change to this route**
If a faster route has been calculated due to a traffic report, the navigation system automatically changes the route.
 - **Request confirmation for route**
If a faster route has been calculated due to a traffic report, the navigation system will ask which route should be used.
 - **Never change my route**

The navigation system will not change the route, even if a traffic announcement has been made.

Setting the navigation system

Setting the voice

The voice used for navigation messages can be changed. It is possible to choose between computer-generated voices or voices recorded by professionals. For voices that have been recorded by professionals, only basic navigation messages will be spoken.

- ▶ Select **System > Sound > Voice.**
- ▶ Select the voice for playback.
- ▶ To listen to the voice, select **Test.**

Setting the voice output



The read-aloud function is only available in a computer-generated voice.

- ▶ Select **System > Sound > Voice output settings.**
- ▶ Select one of the following settings:
 - Read early warning instructions
 - Read aloud motorway lane instructions
 - Read aloud traffic info when navigating
 - Read aloud foreign street names
 - Read aloud road numbers
 - Read aloud street names
 - Read aloud weather information
 - Read aloud POI warnings
 - Read aloud warnings
 - Read aloud signposts

Changing the map

- ▶ Select **Navigation > Settings > Switch map.**
- ▶ Select the desired map.

Changing the map colours

- ▶ Select **Navigation > Settings > Change map colours**.
- ▶ Press  or  to select the desired display.

Changing the E-vehicle settings

- ▶ Select **Navigation > Settings > E-vehicle settings**.

The following functions can be called up:

- deactivating or activating the battery warning

When the charge status of the high-voltage battery has reached 20% and the battery warning is activated, a display message appears.

- showing or hiding charging stations on the map
- managing charging stations
- selecting the charging cable

The settings for both the type of charging and charging cable are used by the navigation system to refine the selection of available charging stations. During navigation, the following options can be selected via the  context menu:

- search for type of charging
- search for electricity provider
- display all charging stations

A display message appears if there is some incompatibility between the defined settings and a selected charging station.

Setting safety warnings

- ▶ Select **System > Safety warnings**.
- ▶ Select the desired settings:
 - **Suggest driving breaks**
 - **Warn when driving near schools**
 - **Warn when driving faster than allowed**
 - **Warn when driving faster than a set speed**
- ▶ Select **Resume**.
- ▶ Select a warning tone for the respective safety warning.

For the "Warn when driving faster than a set speed" function, the speed above which the warning tone should sound must be entered.

Setting the units of measurement for distance

All units of measurement for distance in the navigation system can be changed. The units of measurement for distance of other displays are not changed, such as distance displays for the eco score or the on-board computer.

- ▶ Select **System > Set units > Distance units**.
- ▶ Select one of the following settings:
 - **Kilometres**
 - **Miles**

Setting the units for GPS coordinates

- ▶ Select **System > Set units > GPS coordinate display**.
- ▶ Select one of the following settings:
 - **Degrees (d°)**
 - **Degrees, Minutes (d° m.m')**
 - **Degrees, Minutes, Seconds (d° m' s'')**

Online access to the vehicle

WARNING

If you operate information and communication equipment integrated in the vehicle when driving, you could be distracted from the traffic situation. This could also cause you to lose control of the vehicle. There is a risk of an accident.

Only operate this equipment when the traffic situation permits. If you cannot be sure of this, stop the vehicle paying attention to road and traffic conditions and operate the equipment with the vehicle stationary.

WARNING

If you use mobile information systems and communications devices while driving, you will be distracted from traffic conditions. You could then lose control of the vehicle. There is a risk of an accident.

Only operate these devices when the vehicle is stationary.

Observe the legal requirements for the country in which you are currently driving.

You can use "smart control" to access remote query and to configure your vehicle remotely. It can be accessed from computers and smartphones. The Internet address is available from any smart centre. It is also possible to call up "smart control" via the smart website.

Access to "smart control" is free of charge for the first three years commencing from hand-over of the new vehicle, subject to the availability of the service. Thereafter you can continue to subscribe to use the "smart control" service.

The availability and features of "smart control" may vary from country to country.

Requirements for the use of "smart control":

- Registration on the "smart portal" Internet page via smart.com/portal.

A valid e-mail address or mobile phone number is necessary for registration and the terms of use must be accepted.

- The vehicle must be linked with a personal "smart portal" account at a smart centre. Verification and presentation of the vehicle registration document are required to link the vehicle. The vehicle identification number (VIN) is also required.
- The desired functions must be activated after linking the vehicle.

For activation, the "smart control" terms of use for both the remote query and remote configuration must be accepted via the "smart portal". The portal address is supplied by the smart centre.

- The vehicle must be connected to the Internet.

Connection is made possible via the mobile communications module integrated in the vehicle.

Once these requirements are fulfilled, the following functions, for example, may be used:

- Calling up the current locking status of the vehicle.
- Calling up information on the distance before the next recommended service or if a service is already due.
- Calling up the current vehicle position in the range of approx. 1.5 km around the vehicle.

During the charging process, additional displays can be called up such as the predicted time until charging is completed or the charging capacity.

If there is a delay in the synchronisation of data via the mobile phone network, the displays in the vehicle and at "smart control" may temporarily differ from each other.

Further information on "smart control" is available at any smart centre and via www.smart.com/smartcontrol.

Using smart "ready to" services

Useful information

smart "ready to" services are only available in certain countries.

The functions are enabled via a communication module and the smart "ready to" app.

Information as well as the Internet addresses for the smart "ready to" services are available at any smart centre.

- i** If you are already using a smart "ready to" service, additional services can be activated with your user details in the usual web portal or via the app.

The communication module and activation are required in order to use the smart "ready to" services:

- Register on the "ready to" web portal.
A valid e-mail address and the vehicle identification number (VIN) are necessary for registration, and the conditions of use must be accepted.
- Install the "ready to" app on your smartphone and create a user account.

Using the Key Card Holder

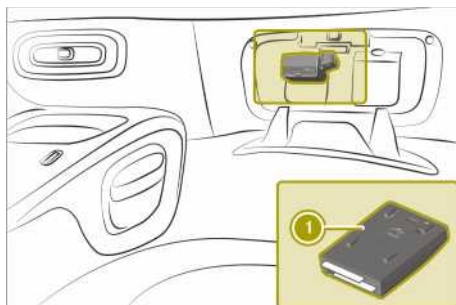

Key Card Holder ① is fitted in the glove compartment and is intended for the storage and inventory of the vehicle key and up to two cards (e.g. fuel card, parking card or car wash card).

The inventory is available within certain smart "ready to" services.

For an inventory, the key and/or the cards must be equipped with an RFID tag.

Stowing small objects

Please note

WARNING

If you stow objects in the vehicle interior in an unsuitable way, they could slip or be thrown around and thus hit vehicle occupants. Additionally, the cup holders, open stowage spaces and mobile phone brackets cannot restrain the objects placed in them in the event of an accident. There is a risk of injury, especially in the event of braking or sudden changes in direction.

- Always stow objects so they cannot be thrown around in these or similar situations.
- Always ensure that objects do not protrude over the top of stowage compartments or ruffled pockets.
- All closable stowage compartments should be closed before beginning your journey.
- Always stow and secure heavy, hard, pointed, sharp-edged, fragile objects or objects which are too large behind the last bench seat or under the passenger seats.

WARNING

The cup holder cannot secure a drinks container in place during a journey. If you use a cup holder during a journey, the drinks container could be flung around and liquid could be spilt. Vehicle occupants could come into contact with the liquid and, in particular, be scalded by hot liquid. You could be distracted from the traffic situation and lose control of the vehicle. There is a risk of an accident and injury.

Only use the cup holder when the vehicle is stationary. Only place containers of a suitable size in the cup holder. Seal the container, in particular when it contains hot liquid.

- ❗ Only use the cup holders for containers of the right size and which have lids. The drinks could otherwise spill.

Using the compartments

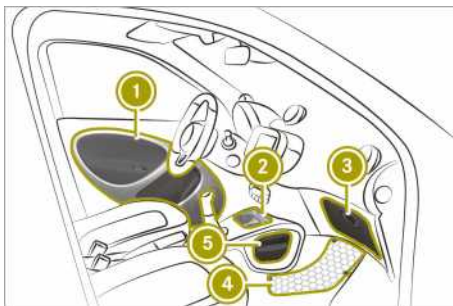

- To stow objects, use suitable stowage spaces. The following stowage spaces are available:
 - ① Stowage compartments in the doors
 - ② Cup holder in the front centre console
 - ③ Glove compartment
 - ④ Stowage net in the front-passenger footwell
 - ⑤ Sliding drawer in the centre console
 - Bracket on the seat for a tablet
 - Velcro strip on the front passenger seat for stowing a handbag
 - Cup holder in the rear centre console with a recess for storing a mobile phone
 - **readyspace seats:** cargo box with cup holders in the rear compartment
 - Parcel shelf

Locking/unlocking the glove compartment

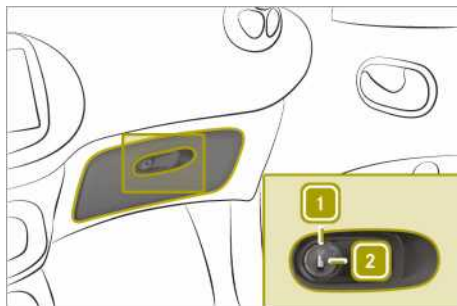

- ▶ Insert the key into the lock.
- ▶ **To lock:** turn the key to position 2.
- ▶ **To unlock:** turn the key to position 1.

Using the rear cup holders (readyspace seats)

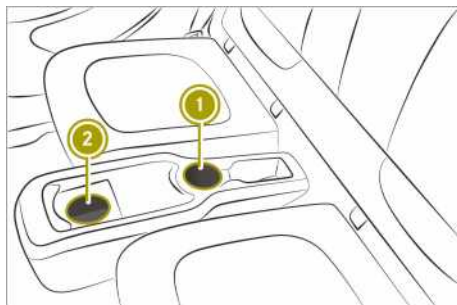

In conjunction with readyspace seats, two cup holders ① and ② are available for use in the rear.

- ▶ Open the stowage compartment in order to use cup holder ②.
- Cup holder ② can be removed. The maximum load for the stowage compartment is 1 kg.

Removing and fitting the rear shelf

Removing the rear shelf

- ! The maximum load which may be placed on the parcel shelf is 3 kg.

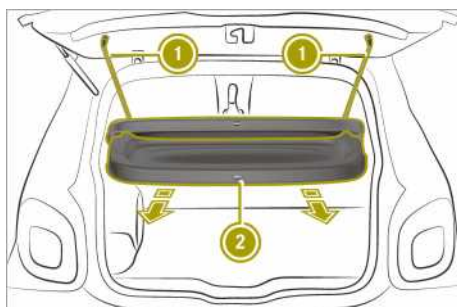

- ① Straps
 - ② Rear shelf
- ▶ Detach the straps from the tailgate.
 - ▶ Fold down the rear shelf.
 - ▶ Pull the rear shelf out to the rear.

Fitting the rear shelf

- ▶ Place the rear shelf on the guide rails on the left and right.
- ▶ Push the rear shelf forwards until it engages.
- ▶ Fold the rear shelf upwards.
- ▶ Attach straps to the tailgate.

Stowing luggage and large objects

Please note

⚠ WARNING

If you stow objects in the vehicle interior in an unsuitable way, they could slip or be thrown around and thus hit vehicle occupants. Additionally, the cup holders, open stowage spaces and mobile phone brackets cannot restrain the objects placed in them in the event of an accident. There is a risk of injury, especially in the event of braking or sudden changes in direction.

- Always stow objects so they cannot be thrown around in these or similar situations.
- Always ensure that objects do not protrude over the top of stowage compartments or ruffled pockets.

- All closable stowage compartments should be closed before beginning your journey.
- Always stow and secure heavy, hard, pointed, sharp-edged, fragile objects or objects which are too large behind the last bench seat or under the passenger seats.

The handling characteristics of a laden vehicle are dependent on the distribution of the load within the vehicle.

Observe the following loading guidelines when loading and transporting luggage and loads:

- do not exceed the maximum permissible gross vehicle weight or the permissible axle loads for the vehicle (including occupants)
- the load compartment is the preferred place to stow objects
- stow heavy loads as far forwards and as low down in the load compartment as possible
- the load must not protrude above the upper edge of the seat backrests
- always place the load against the rear or front seat backrests. Make sure that the seat backrests are securely locked in place.
- always transport the load behind unoccupied seats if possible
- secure the load and luggage suitably

Opening the boot

- !** The tailgate swings upwards and to the rear when opened. Therefore, make sure that there is sufficient clearance above and behind the tailgate.

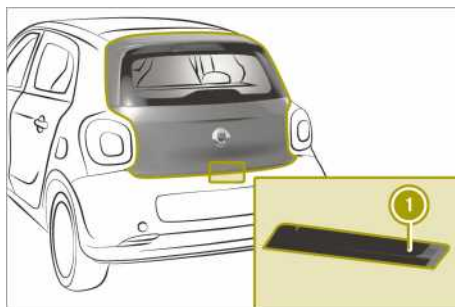

- ▶ Press the  button on the key.
- ▶ Press button ①.
- ▶ Fold the tailgate up.

Closing the boot

- ▶ Pull the tailgate down and close.
- ▶ Press the  button on the key. The vehicle is locked.

Using lashing eyelets

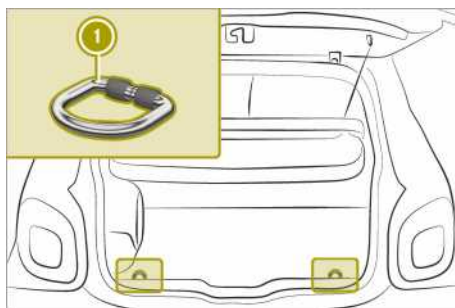

To prevent damage, observe the following:

- Secure the load using lashing eyelets ①.
- Distribute the load on the lashing eyelets evenly.
- Do not use elastic straps or nets.
- Pad any sharp edges.

Enlarging the load compartment

Folding the rear seat backrest forward

⚠ WARNING

If the rear bench seat/rear seat and seat backrest are not engaged they could fold forwards, e.g. when braking suddenly or in the event of an accident.

- The vehicle occupant would thereby be pushed into the seat belt by the rear bench seat/rear seat or by the seat backrest. The seat belt cannot protect as intended and could result in additional injury.
- Objects or loads in the boot/luggage compartment cannot be restrained by the seat backrest.

This poses an increased risk of injury.

Before every trip, make sure that the seat backrests and the rear bench seat/rear seat are engaged before every trip.

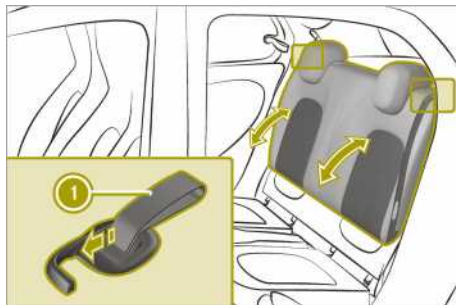

- ▶ Push the head restraints all the way in.
- ▶ Pull right or left loop (1) on the seat backrest in the direction of the arrow.
- ▶ Fold down the seat backrest fully.

Folding back the rear seat backrests

- !** Make sure that the seat belt does not become trapped when folding the rear seat backrest back. Otherwise, it could be damaged.

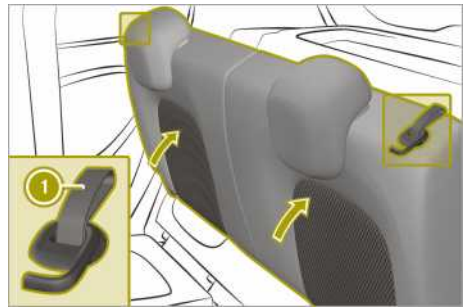

- ▶ Fold back the left or right seat backrest until it engages. Red lock status indicator (1) on the loop must no longer be visible.

Folding the front-passenger seat backrest forwards

Folding down the front-passenger seat backrest (using the lever)

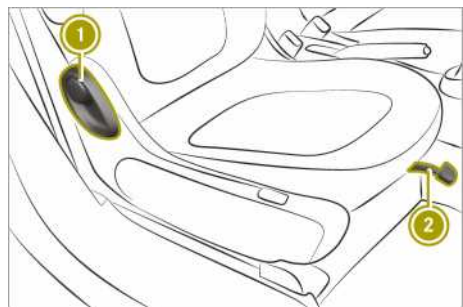

Seat with a lever

- ▶ Lift lever (2) and slide the front passenger seat to its rearmost position.
- ▶ Pull lever (1) forwards.
- ▶ Fold the seat backrest forwards at the same time.

Folding down the front-passenger seat backrest (using the handwheel)

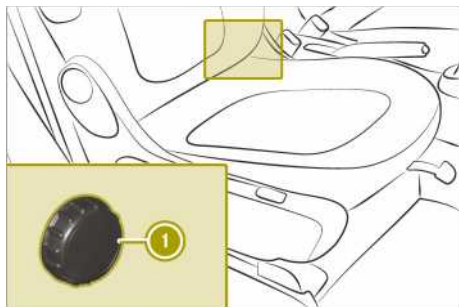

Seat with a handwheel

- ▶ Turn handwheel ① forward.

Folding back the front-passenger seat backrest

Please note

⚠ WARNING

If the seat backrest is not engaged, it may fold forwards, e.g. during braking or in the event of an accident.

- As a result, a backrest which is not engaged would press you into the seat belt. The seat belt cannot perform its intended protective function and could additionally cause injury.
- The backrest cannot restrain objects or loads in the boot.

This poses an increased risk of injury.

Before every journey, make sure that the backrest is engaged as described.

Folding back the front-passenger seat backrest (using the lever)

- ▶ Pull lever ①.
- ▶ Push the seat backrest back at the same time until it engages.

Folding back the front-passenger seat backrest (using the handwheel)

- ▶ Turn handwheel ① backwards.

Adjusting the angle of the rear seat backrests (cargo position)

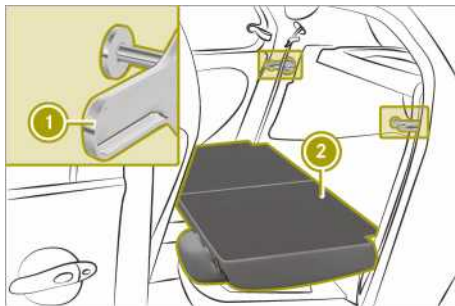

- ▶ Release right-hand or left-hand seat backrest ②.
- ▶ Fold right-hand or left-hand seat backrest ② slightly forwards.
- ▶ Fold seat backrest catch ① forwards.
- ▶ Fold right-hand or left-hand seat backrest ② back to seat backrest catch ① until it engages.

Folding seat cushions forwards (ready-space seats)

⚠ WARNING

If you rotate the rear seat cushion when the cargo box is removed, you or other vehicle occupants could be caught in the seat mechanism. There is a risk of injury.

Only rotate the seat cushion if the cargo box is fitted. Ensure that no parts of the body are in the immediate vicinity of moving parts.

- ⚠ Do not fold the rear seat backrests forwards if the rear seat cushions have been rotated. Otherwise, the rear seat backrests may be damaged.

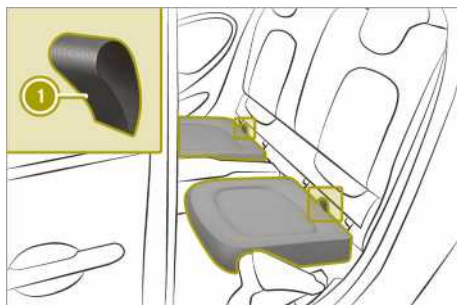

- ▶ Pull loop ① and fold the seat cushion forwards.

Removing the cargo box (readyspace seats)

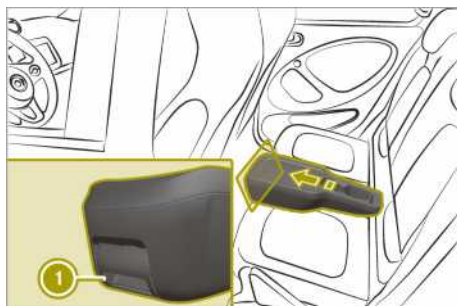

- ▶ Release the cargo box using handle ①.
- ▶ Using both hands, reach into the handle recesses at the front and behind and push the cargo box forwards and up at a slight angle.
- ▶ Remove the cargo box.

Removing/fitting the charging cable bag

Removing the charging cable bag

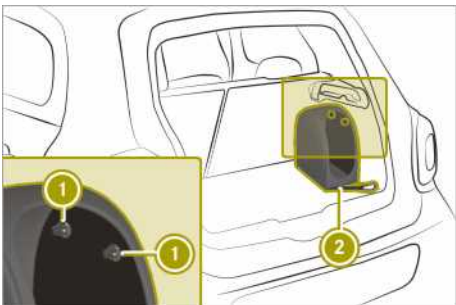

- ▶ Turn both buttons ① to the left. The buttons are released from the anchorage.
- ▶ Fold the charging cable bag to the left. The Velcro fasteners under the charging cable bag are detached.
- ▶ Remove snap hook ②.

Installing the charging cable bag

- ▶ Place the charging cable bag with its side resting on the engine compartment cover and then position it on the side trim.
- ▶ Position the charging cable bag in a vertical position. Take hold of the Velcro fasteners beneath the charging cable bag.
- ▶ Push both buttons ① into the anchorage and turn them to the right.
- ▶ Secure snap hook ②.

Useful information

The engine compartment in the smart is located at the rear, below the boot. Service fluid reservoirs are located under the service cover at the front.

When working on the vehicle, always comply with all safety regulations. Always have work in the engine compartment carried out at a qualified specialist workshop.

Removing/fitting the subwoofer

Removing the subwoofer

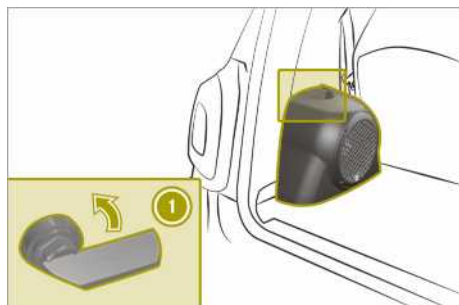

- ▶ Release quick-release fastener ① in the direction of the arrow.
- ▶ Reach into the recess on the quick-release fastener.
- ▶ Detach, tilt and pull the subwoofer to the right.
- ▶ Pull out the connector.

Fitting the subwoofer

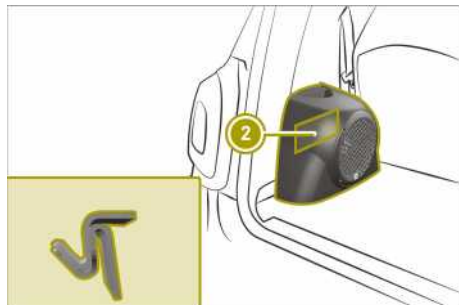

- ▶ Insert the connector.
- ▶ Place the subwoofer at the base of the side trim.
- ▶ Turn quick-release fastener ① upwards.
- ▶ Press the bracket into the recess in side trim ②.
- ▶ Turn quick-release fastener ① to the right.

Opening and closing the service cover

Please note

⚠ WARNING

If the service cover is not locked, it may come loose during driving and block your view or endanger other road users. There is a risk of an accident and injury.

Therefore, make sure that the service cover is locked before driving off.

⚠ WARNING

If the windscreen wipers start to move when the service cover is open, you could become caught up in the wiper rods. There is a risk of injury.

Always switch off the windscreen wipers and the ignition before you open the service cover.

- ❗ To ensure unhindered air intake, completely remove any dirt or snow from the ventilation slots above the service cover.

The vehicle must be secured against rolling away.

On vehicles with a lockable service cover, the service cover must be unlocked before it is opened.

Unlocking the service cover

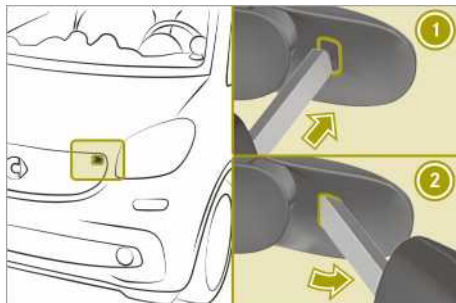

- ▶ Insert the tip of the key into the opening of lock cover ①.
- ▶ Press the key to the right ② to lever up the lock cover.
- ▶ Remove the lock cover.
- ▶ Insert the key into the lock and turn it 90° clockwise.

Opening the service cover

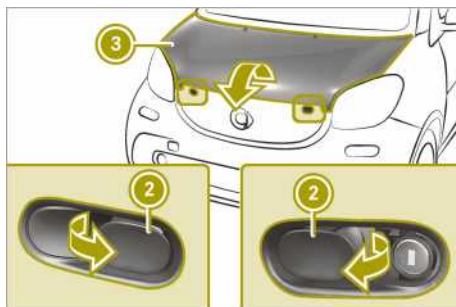

- ▶ Pull both levers ② in the direction of the arrow.
- ▶ Lift service cover ③ at the front.
- ▶ Pull service cover ③ slightly forwards and lift upwards.
- ▶ Put down service cover ③.

Closing the service cover

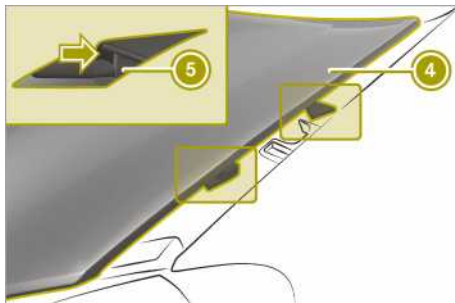

- ▶ Unhook service cover ③.
- ▶ Slide bars ⑤ on the left and right of the service cover under the bars on wing ④.

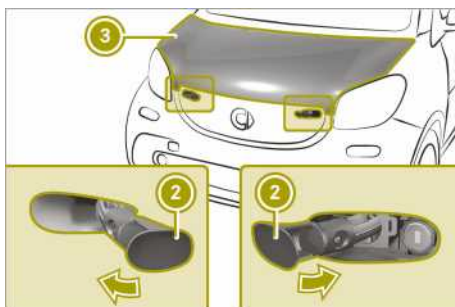

- ▶ Press service cover ③ downwards.
- ▶ Press both levers ② backwards in the direction of the arrow.

Locking the service cover

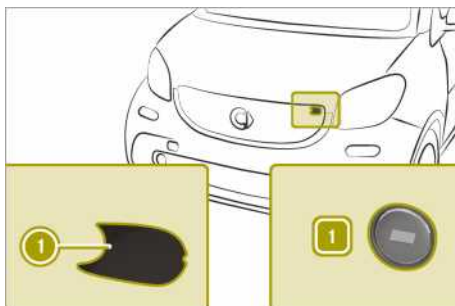

- ▶ Insert the key into the lock and turn it to position 1.
- ▶ Insert lock cover ① on the driver's side and snap it into place.

Checking service products and topping up

Please note

WARNING

Service product can be poisonous and hazardous to health. There is a risk of injury. Observe the instructions on the respective original container when using, storing and disposing off service products. Always store service products in the sealed original container. Always keep service products out of the reach of children.

Environmental note

Dispose of service products in an environmentally-responsible manner.

Also observe the information in the "Service products" section (▷ page 209).

Service products include the following:

- Coolant
- Brake fluid
- Windscreen washer fluid
- Climate control system refrigerant

Service products approved for smart:
<http://bevo.mercedes-benz.com>

Checking the coolant and topping up

Checking the coolant level

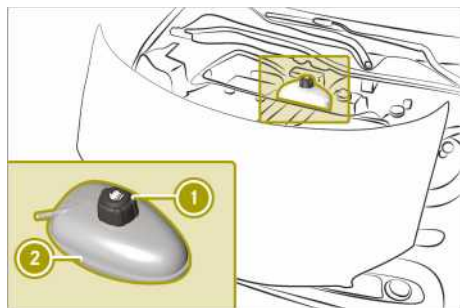

- ▶ Stop the vehicle on a level surface.
- ▶ Let the coolant cool down for at least 30 minutes.

- ▶ Open the service cover.
- ▶ Check reservoir ② visually.
The fluid level must be between the MIN mark and the MAX mark.

Topping up the coolant

WARNING

The cooling system is pressurised when the drive system is at normal operating temperature. When you open the cap, you could be scalded by hot coolant spraying out. There is a risk of injury.

Let the drive system cool down before you open the cap. Wear protective gloves and eye protection when opening. Open the cap slowly to relieve pressure.

- ❗ Only add coolant that has been premixed with the desired antifreeze protection. You could otherwise damage the engine.

Further information on coolants can be found in the Mercedes-Benz Specifications for Service Products, MB BeVo 310.1, e.g. on the Internet at

<http://bevo.mercedes-benz.com>. Or contact a qualified specialist workshop.

If antifreeze/corrosion inhibitor is present in the correct concentration, the boiling point of the coolant during operation is approximately 130 °C.

The antifreeze/corrosion inhibitor concentration in the engine cooling system should be between 40% and 50% (antifreeze protection down to -37 °C). This will protect the engine cooling system against freezing down to approximately -25 °C.

- ▶ Cover cap ① of coolant expansion tank ② with a cloth.
- ▶ Turn the cap slowly one half turn. If necessary, allow excess pressure to escape.
- ▶ Turn the cap further and remove it.
- ▶ Top up the coolant to the MAX level.
- ▶ Replace the cap and tighten it as far as it will go.
- ▶ Close the service cover.

-  See "Technical data" for information on recommended coolants.

Topping up the washer fluid

⚠ WARNING

Windscreen washer concentrate is highly flammable. If it comes into contact with hot components in the front compartment, it may ignite. There is a risk of fire and injury.

Make sure that windscreen washer concentrate is not spilled next to the filler neck.

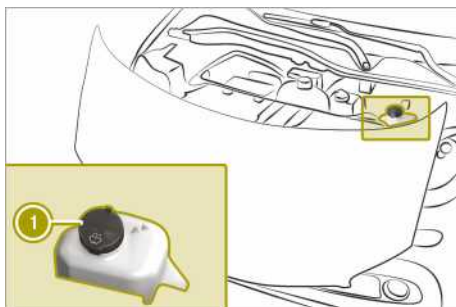

- ▶ Open the service cover.
- ▶ Pull cap ① upwards at the tab.
- ▶ If available, pull the removable nozzle up as far as the stop.
- ▶ Top up with washer fluid.
- ▶ If available, push the removable nozzle down and push it inside.
- ▶ Replace and tightly screw on cap ①.
- ▶ Close the service cover.

i See "Technical data" for information on windscreen washer fluid and antifreeze.

Checking wheels and tyres

⚠ Warning

A flat tyre severely impairs the driving, steering and braking characteristics of the vehicle. There is a risk of an accident.

Do not drive with a flat tyre. Immediately replace the flat tyre with your spare wheel, or consult a qualified specialist workshop.

⚠ WARNING

Damaged tyres can cause tyre inflation pressure loss. As a result, you could lose control of your vehicle. There is a risk of accident.

Check the tyres regularly for signs of damage and replace any damaged tyres immediately.

⚠ WARNING

Insufficient tyre tread will reduce tyre traction. The tyre is no longer able to dissipate water. This means that on wet road surfaces, the risk of aquaplaning increases, in particular where speed is not adapted to suit the driving conditions. There is a risk of accident.

If the tyre pressure is too high or too low, tyres may exhibit different levels of wear at different locations on the tyre tread. Thus, you should regularly check the tread depth and the condition of the tread across the entire width of all tyres.

Minimum tyre tread depth for:

- summer tyres: 3 mm
- M+S tyres: 4 mm

For safety reasons, replace the tyres before the legally prescribed limit for the minimum tyre tread depth is reached.

! If you cannot avoid driving over obstacles, e.g. kerbs, do so slowly and at an obtuse angle only. You could otherwise damage the wheel rims and tyres.

Modification work on the brake system and wheels is not permitted. The use of spacers or brake dust shields is not permitted. This invalidates the general operating permit for the vehicle.

Check the wheels and tyres for damage at least once a month, as well as after driving off-road or on poorly surfaced roads.

Run-in new tyres at moderate speeds for the first 100 km. The tyres only attain their maximum performance after this distance.

Vibrations, audible noises and unusual handling characteristics, e.g. pulling to one side, can indicate damage to wheels or tyres.

If you suspect a tyre defect:

- ▶ Reduce vehicle speed.
- ▶ Stop the vehicle as soon as possible.
- ▶ Check the wheels and tyres for damage. If you find no signs of damage, have the wheels and tyres checked at a specialist workshop.

Changing a wheel

Please note

WARNING

Interchanging the front and rear wheels may severely impair the driving characteristics if the wheels or tyres have different dimensions. The wheel brakes or suspension components may also be damaged. There is a risk of accident.

Interchange front and rear wheels only if the wheels and tyres are of the same dimensions.

WARNING

Exceeding the stated tyre load-bearing capacity and the approved maximum speed could lead to tyre damage or the tyre bursting. There is a risk of accident.

Therefore, only use tyre types and sizes approved for your vehicle model. Observe the tyre load rating and speed rating required for your vehicle.

WARNING

If wheels and tyres of the wrong size are used, the wheel brakes or suspension components may be damaged. There is a risk of an accident.

Always replace wheels and tyres with those that fulfil the specifications of the original part.

When replacing wheels, make sure to fit the correct:

- designation
- type

When replacing tyres, make sure to fit the correct:

- designation
- manufacturer
- type

 On vehicles fitted with a tyre pressure monitor, electronic components are located in the wheel.

Tyre-fitting tools should not be applied in the area of the valve, since this could damage the electronic components.

Only have tyres changed at a qualified specialist workshop.

 Position a suitable jack only on the jacking points intended for this purpose. Raise the vehicle for a short time only to change the wheel. Make sure the vehicle is on a suitable surface and that no-one is in the vehicle. Secure the vehicle using chocks and apply the parking brake.

Interchanging front and rear wheels or tires of differing dimensions can render the general operating permit invalid.

Rules for selecting new tyres

 For safety reasons, smart recommends that you only use tyres and wheels which have been specifically approved by smart for your vehicle. These are specially adapted to the control systems, such as ABS or ESP®.

Only use tyres and wheels specifically tested and approved by smart. Certain characteristics, e.g. handling, vehicle noise emissions or fuel consumption, may otherwise be adversely affected. In addition, when driving with a load, dimensional variations and different tyre deformation characteristics could cause the tyres to make contact with the bodywork and axle components. This could result in damage to the tyres or the vehicle.

smart accepts no liability for damage resulting from the use of tyres or wheels other than those tested and approved.

Information on wheels and tyres can be obtained at a qualified specialist workshop, e.g. a smart centre.

The service life of tyres depends on various factors, including the following:

- Driving style
- Tyre pressure
- Mileage

Observe the following rules for selecting new tyres:

- Observe country-specific regulations which stipulate or recommend a certain tyre type for the vehicle.
- Only fit tyres and wheels of the same type and make.
- Only tyres of the same size may be used on a single axle (left/right).
- Only use tyres of the same type (summer tyres, all-season tyres, winter tyres).
- Use only wheel-tyre combinations approved by smart.
- Do not wear tyres out too much. This otherwise significantly reduces the traction on wet roads (aquaplaning).
- Replace tyres after six years at the latest.

i Recommended tyre pressures for various operating states can be found on the tyre pressure table on the driver's side door pillar (B-pillar).

You can find further information regarding tyres and wheels at specialist tyre retailers, at qualified specialist workshops and at any smart centre.

Preparing to change a wheel

The vehicle tool tray is located under the glove compartment.

- ▶ Stop the vehicle on solid, non-slippery and level ground.
- ▶ Apply the parking brake.
- ▶ Position the front wheels to point straight ahead.
- ▶ Shift the transmission to position **P**.
- ▶ Switch off the engine.
- ▶ Remove the key from ignition lock.
- ▶ Secure the vehicle against rolling away.

Removing a wheel

WARNING

If you do not position the jack correctly at the appropriate jacking point of the vehicle, the jack could tip over with the vehicle raised. There is a risk of injury.

Only position the jack at the appropriate jacking point of the vehicle. The base of the jack must be positioned vertically, directly under the jacking point of the vehicle.

! Do not place wheel bolts in sand or dirt. The threads of the wheel bolts and wheel hubs could otherwise be damaged when the bolts are tightened.

! Position a suitable jack only on the jacking points intended for this purpose.

Never position the jack on the high-voltage battery. Do not jack up the vehicle on the high-voltage battery. There is otherwise a risk of damaging the high-voltage battery.

Also observe the notes in the "Changing a wheel" section.

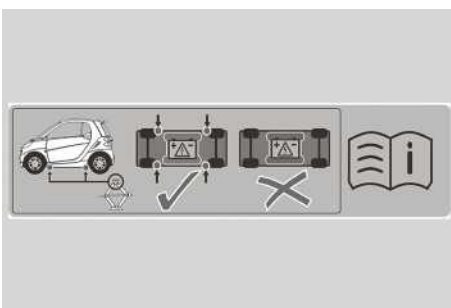

Warning stickers

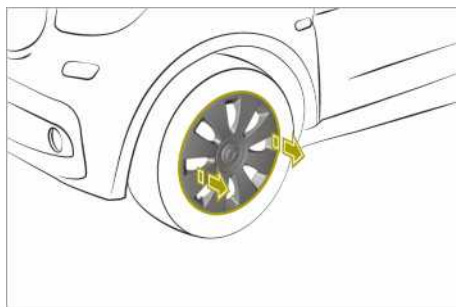

Vehicles with steel wheels and hub caps:

- ▶ Using both hands, grasp two hub cap openings and remove the hub cap.

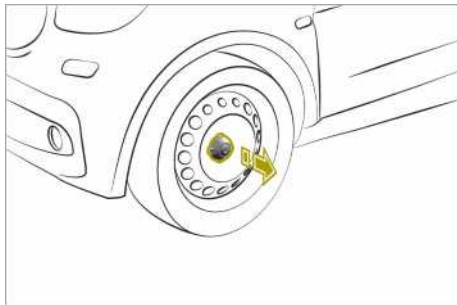
**Vehicles with steel wheels and hub cap cover:**

- ▶ Remove the hub cap cover.

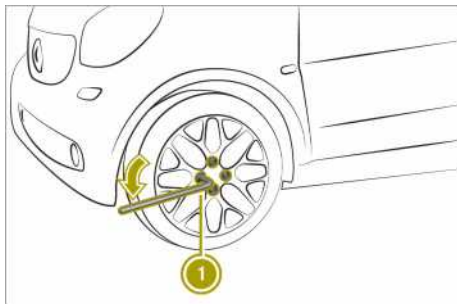

- ▶ Using wheel wrench ① loosen the wheel bolts by about one turn. Do not unscrew the wheel bolts completely.

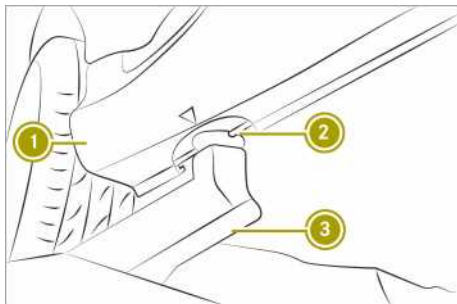

The vehicle may only be raised at the designated jacking points. These points ② are located in the front and the rear directly next to the wheels. Do not position jack ③ on the edge of sill ①. Otherwise, damage to the vehicle could occur.

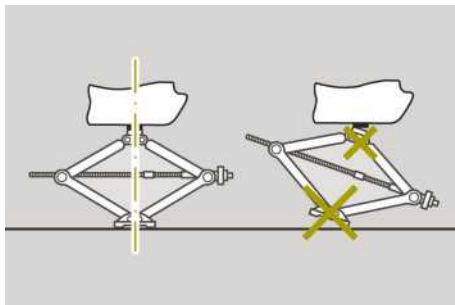
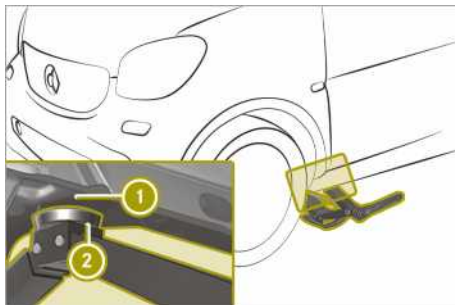

- ▶ Position jack ② behind the triangular indentations for jacking point ①.
- ▶ Set the foot of the jack up vertically with respect to the jacking point on the vehicle.
- ▶ Raise the vehicle using the jack until the tyre is a maximum of 3 cm off the ground.
- ▶ Unscrew and remove the wheel bolts.
- ▶ Remove the wheel.

Fitting a wheel**⚠ WARNING**

The wheels could work loose if the wheel nuts and bolts are not tightened to the specified tightening torque. There is a risk of accident.

Have the tightening torque immediately checked at a qualified specialist workshop after a wheel is changed.

⚠ WARNING

If you tighten the wheel bolts or wheel nuts when the vehicle is raised, the jack could tip over. There is a risk of injury.

Only tighten the wheel bolts or wheel nuts when the vehicle is on the ground.

- ! When changing a wheel, use only wheel bolts that have been approved for the wheel rim and vehicle.

Always pay attention to the instructions and safety notices in "Changing a wheel" (▷ page 158).

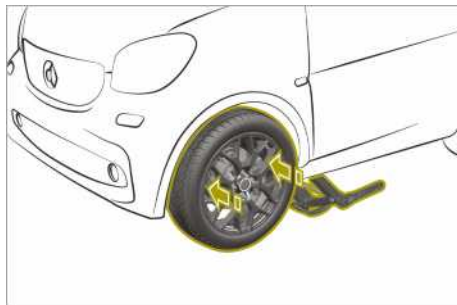

Fit tyres with a specified direction of rotation only according to their direction of rotation. An arrow on the sidewall of the tyre indicates its correct direction of rotation.

- ▶ Clean the wheel and wheel hub contact surfaces.
- ▶ Push the wheel onto the wheel hub and press it on.
- ▶ Screw in the wheel bolts and tighten them slightly.

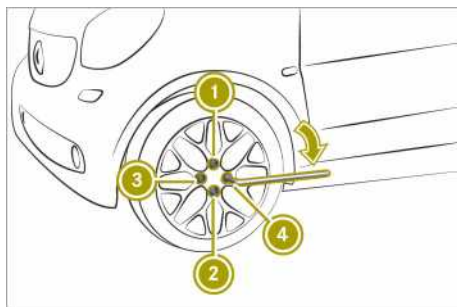

- ▶ Lower the vehicle all the way.
- ▶ Remove the jack.
- ▶ Tighten the wheel bolts evenly in a cross-wise pattern in sequence indicated ①

to ④. The tightening torque must be 105 Nm.

- ▶ Check the recommended tyre pressure and adjust if necessary.
- i Vehicles with tyre pressure control system: all fitted wheels must be equipped with functioning sensors.

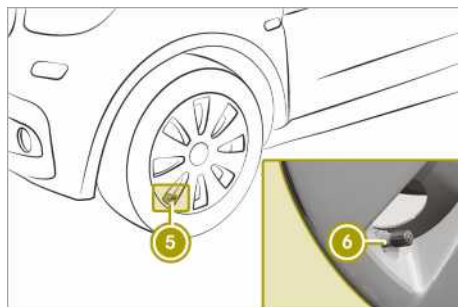

Vehicles with steel wheels and hub caps:

- ▶ Fit hub cap ⑤ such that valve ⑥ does not become trapped.
- ▶ Press the hub cap evenly onto the wheel with both hands until you hear the hub cap engage.
- ▶ Check to make sure the hub cap is seated securely on the wheel.

Vehicle with steel wheels and wheel hub covers:

- ▶ Fit the hub cap cover.

Storing wheels

- ▶ Store wheels in a cool, dry and dark place when not in use.
- ▶ Protect against oil, grease and fuel.

Using the tyre pressure monitor

Useful information

It is the driver's responsibility to set the tyre pressure to the recommended cold tyre pressure suitable for the operating situation.

The tyre pressure monitor issues a warning when the pressure drops in one or more of the tyres.

The tyre pressure monitor works properly only if sensors are present in all four tyres,



and after the monitor has learned the correct tyre pressure for the current operating situation. This occurs automatically in most situations, but may also be specified after restarting the tyre pressure monitor. Before restarting, check the tyres for the recommended tyre pressure.

The tyre pressure monitor does not provide a warning in the following cases:

- Even loss of pressure on multiple tyres
- Sudden loss of tyre pressure, e.g. due to penetration by a foreign body
- Incorrectly set tyre pressure

The tyre pressure monitor has a yellow warning lamp in the instrument cluster for indicating a pressure loss or malfunction.

Restarting the tyre pressure monitor (on-board computer with a mono-chrome display)

- ▶ Set the tyre pressure of all tyres to the recommended value.
- ▶ On the multifunction lever press the  button repeatedly until the **SET** and  symbols are displayed in the instrument cluster display.
- ▶ Press and hold the **OK** button on the multifunction lever.
The **SET** and  symbols flash in the instrument cluster display for approximately five seconds. The two symbols then light up.

The tyre pressure monitor is restarted.

Restarting the tyre pressure monitor (on-board computer with colour display)

- ▶ Set the tyre pressure of all tyres to the recommended value.
- ▶ Select **Settings > Tyre pressure monitor** in the on-board computer.
The **Tyre pressure monitor Adopt current pressures as new reference values?** message appears in the display.
- ▶ Select **yes** and press **OK** to confirm.
The display shows the **Tyre pressure monitor restarted** message.

If the **Tyre pressure monitor restarted** message does not appear after five seconds, restart the tyre pressure monitor again.

Checking the tyre pressures

Please note

WARNING

Underinflated or overinflated tyres pose the following risks:

- the tyres may burst, especially as the load and vehicle speed increase.
- the tyres may wear excessively and/or unevenly, which may greatly impair tyre traction.
- the driving characteristics, as well as steering and braking, may be greatly impaired.

There is a risk of an accident.

Observe the recommended tyre pressure and check the tyre pressure of all the tyres:

- at least every two weeks
- when the load changes
- before embarking on a longer journey
- for changed operating conditions, e.g. off-road driving

If necessary, correct the tyre pressure.

WARNING

If you mount unsuitable accessories onto tyre valves, the tyre valves may be overloaded and malfunction, which can cause tyre pressure loss. Aftermarket tyre pressure monitoring systems will cause the tyre valve to remain open. This can also result in tyre pressure loss. There is a risk of an accident.

Only screw standard valve caps or valve caps specifically approved by smart for your vehicle onto the tyre valve.

WARNING

If the tyre pressure drops repeatedly, the wheel, valve or tyre may be damaged. Tyre

pressure that is too low may result in a tyre blow-out. There is a risk of accident.

- Check the tyre for foreign objects.
- Check whether the wheel is losing air or the valve is leaking.

If you are unable to rectify the damage, contact a qualified specialist workshop.

Environmental note

Check the tyre pressure regularly, at least every 14 days.

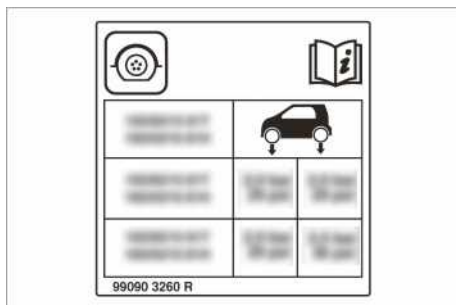

The table with the recommended tyre pressure for various operating conditions can be found on the driver's side door pillar (B-pillar).

The tyre pressure table may also state air pressures for different load conditions. These are defined in the table as different numbers of passengers and amounts of luggage. The actual number of seats may differ from this.

If a tyre size precedes a tyre pressure, the tyre pressure information following is only valid for that tyre size. If tyre sizes are not specified, the tyre pressures stated on the tyre pressure table apply for all approved tyres.

Checking and correcting the tyre pressure manually

Only check the tyre pressure once the tyres have cooled down.

- ▶ Drive the vehicle less than 2 km.
- ▶ Park the vehicle away from direct sunlight for at least three hours.

- ▶ Check the tyre pressure with a suitable tyre pressure gauge.
- ▶ If necessary, adjust the tyre pressure.
- ▶ Restart tyre pressure monitor.

Using winter tyres

WARNING

M+S tyres with a tyre tread depth of less than 4 mm are not suitable for use in winter as they do not provide sufficient traction. There is a risk of accident.

M+S tyres with a tread depth of less than 4 mm must be replaced.

At temperatures below +7 °C, summer tyres lose elasticity and therefore traction and braking power. Change the tyres on your vehicle therefore to winter tyres or all-season tyres marked with M+S. Using summer tyres at very cold temperatures could cause tears to form, thereby damaging the tyres permanently. smart cannot accept responsibility for this type of damage.

Have the vehicle winterproofed at a qualified specialist workshop at the onset of winter.

- ▶ At low temperatures, use only winter tyres marked with M+S.
- ▶ When road conditions are wintry, use M+S tyres with the additional  snowflake symbol. These tyres allow driving safety systems, e.g. ABS, to function optimally in the winter.
- ▶ Use M+S tyres of the same make and tread on all wheels.
- ▶ When driving with M+S tyres, observe the specified maximum permissible speed.
- ▶ Use only tyre types and sizes approved for smart.
- ▶ When using tyres with a specified direction of rotation, observe the arrow on the sidewall indicating the tyre's direction of rotation.

After fitting M+S tyres:

- ▶ Check tyre pressure.
- ▶ Restart tyre pressure monitor.
- ▶ If M+S tyres with a lower maximum permissible speed than that of the vehicle are fitted, affix an appropriate warning label in the driver's field of vision. Using the limiter, restrict the speed to the maximum permissible speed for M+S tyres.

Using snow chains

WARNING

If you have fitted snow chains to the front wheels, they may scrape against the vehicle body or chassis components. This could cause damage to the vehicle or the tyres. There is a risk of an accident.

To avoid hazardous situations:

- never fit snow chains on the front wheels
- fit snow chains to the rear wheels in pairs.

! **Vehicles with steel wheels:** if you fit snow chains on steel wheels, you may damage the hub caps. Remove the hub caps from the relevant wheels before fitting the snow chains.

For safety reasons, smart recommends that you only use snow chains that have been specially approved for your vehicle by smart. Further information can be obtained at a smart centre or a qualified specialist workshop.

- ▶ Observe country-specific regulations.
- ▶ Use only snow chains approved for smart.
- ▶ Fit snow chains on both rear wheels.
- ▶ Use snow chains only on snow-covered roads.
- ▶ When driving with snow chains fitted, do not exceed the maximum permissible speed of 50 km/h.

Changing the window wiper blades

Please note

WARNING

If the windscreen wipers begin to move while you are changing the wiper blades, you can be trapped by the wiper arm. There is a risk of injury.

Always switch off the windscreen wipers and ignition before changing the wiper blades.

- !** Never open the service cover or tailgate if a wiper arm has been folded away from the windscreen or rear window. Never fold a wiper arm without a wiper blade back onto the windscreen or rear window. Hold the wiper arm firmly when you change the wiper blade. If you release the wiper arm without a wiper blade and it falls onto the window, the window may be damaged by the force of the impact.

Changing the window wiper blades on the windscreen

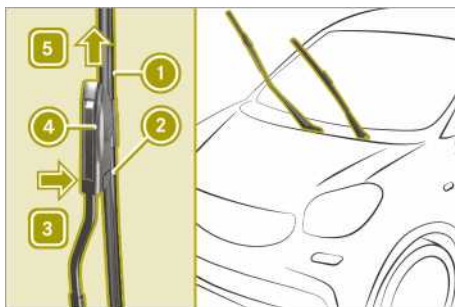

- ▶ Fold the wiper arm away from the windscreen.
- ▶ Press release clips ② on mounting ④ in the direction of windscreen ③. The catch tab is released from the mounting and the window wiper blades can be removed from the wiper arm.
- ▶ Slide window wiper blade ① in the direction of arrow ⑤ until the securing hook for the window wiper blade is revealed.
- ▶ Remove the window wiper blade.

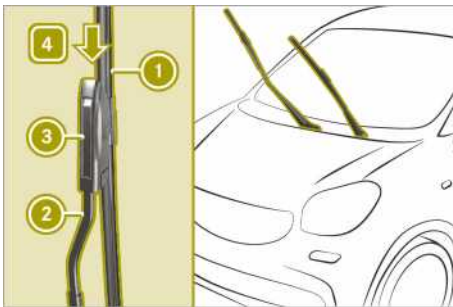

- ▶ Slide new window wiper blade ① in the direction of arrow ④ onto mounting ③ of wiper arm ②.
- The window wiper blade snaps into place.
- ▶ Check that the window wiper blade is positioned correctly.
- ▶ Carefully fold wiper arm ② onto the windscreen.

Changing the rear window wiper blade

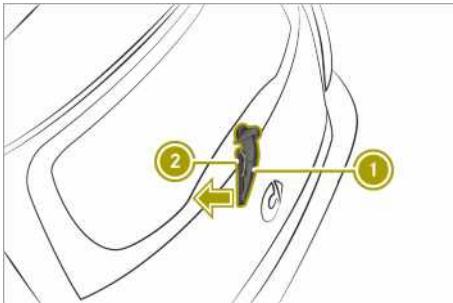

- ▶ Remove key from ignition lock.
- ▶ Fold wiper arm ① away from the rear window until you hear it engage.
- ▶ Pull window wiper blade ② in the direction of the arrow until it is released from the retainer on the wiper arm.
- ▶ Remove window wiper blade ②.
- ▶ Slide new window wiper blade ② onto wiper arm ① until it engages.
- ▶ Turn window wiper blade ② parallel to wiper arm ①.
- ▶ Check that window wiper blade ② is positioned correctly.
- ▶ Fold wiper arm ① back onto the rear window.

Cleaning the vehicle

Useful information

Regular care maintains the appearance and quality of the vehicle over time.

Observe the following when cleaning and caring for the vehicle:

- ▶ Do not clean the engine.
- ▶ Do not clean the vehicle whilst charging.
- ▶ Use soft, moist cloths.
- ▶ Use care products and cleaning agents recommended and approved for smart.
- ▶ Do not use acidic cleaning agents.
- ▶ In winter, carefully remove road salt as soon as possible.

Cleaning the vehicle exterior

Washing in an automatic car wash or washing by hand

Preparing the vehicle for cleaning

WARNING

Braking efficiency is reduced after the vehicle has been washed. There is a risk of an accident.

After washing the vehicle, brake carefully while paying attention to the traffic conditions in order to restore full braking efficiency.

- ▶ Close the side windows completely.
- ▶ Switch off the climate control blower.
- ▶ Turn the windscreen wipers to position 0.

Washing in an automatic car wash

- ▶ Prepare the vehicle for cleaning.
- ▶ Remove excess dirt.
- ▶ Drive through the automatic car wash.
- ▶ Remove wax from the front windscreen and the wiper blades.

i If the windscreen wipers leave smears after the vehicle has passed through the car wash, this may be caused by wax or other residue. This residue can be removed with washer fluid.

Washing by hand

- ▶ Locate a washing bay equipped for hand-washing.
- ▶ Prepare the vehicle for cleaning.
- ▶ Apply mild cleaning agent with a soft vehicle sponge.
- ▶ Thoroughly hose the vehicle with a gentle jet of water; do not point the water jet directly towards the air inlet grille.
- ▶ Dry the vehicle off with a chamois.

Cleaning with a high-pressure cleaner

WARNING

The water jet of circular-jet nozzles (dirt grinders) can cause damage not visible from the outside to tyres or chassis components. Components damaged in this way can unexpectedly fail. There is a risk of an accident.

Do not use high-pressure cleaners with circular-jet nozzles to clean the vehicle. Have damaged tyres or chassis components replaced immediately.

- H** Always maintain a distance of at least 30 cm between the vehicle and the high-pressure cleaner nozzle. Information about the correct distance is available from the equipment manufacturer. Move the high-pressure cleaner nozzle around when cleaning your vehicle. Do not aim directly at any of the following:

- tyres
- door gaps, roof gaps, joints etc.
- electrical components
- battery
- connectors
- lights
- seals
- ventilation slots

Damaged seals or electrical components can lead to leaks or failures.

- ▶ Prepare the vehicle for cleaning.
- ▶ Maintain a distance of at least 30 cm between the high-pressure cleaner nozzle and the vehicle.
- ▶ Keep moving the nozzle whilst cleaning.

Cleaning the reversing camera

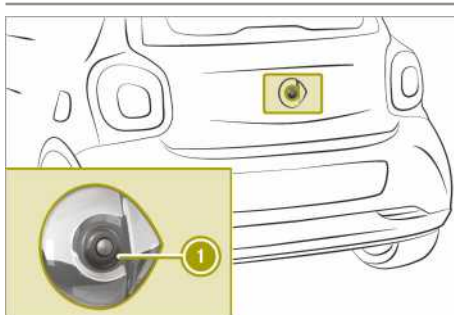

- ▶ Clean camera lens ① with water and a soft cloth.

Cleaning the sensors

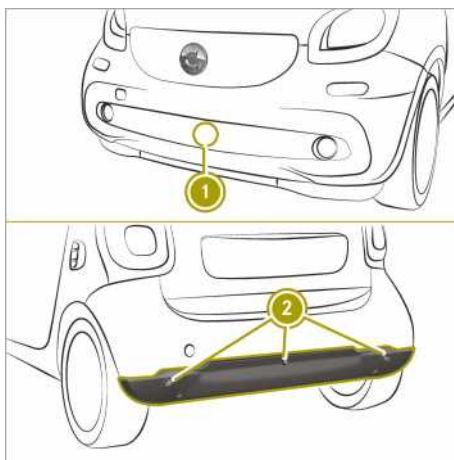

- ① Active Brake Assist sensor
- ② Parking aid sensors

- ▶ Clean sensors with water, car shampoo and a soft cloth.

Cleaning the wheels

WARNING

The water jet of circular-jet nozzles (dirt grinders) can cause damage not visible from the outside to tyres or chassis components. Components damaged in this way can unexpectedly fail. There is a risk of an accident.

Do not use high-pressure cleaners with circular-jet nozzles to clean the vehicle. Have damaged tyres or chassis components replaced immediately.

! Do not use acidic wheel cleaning products to remove brake dust. This could damage wheel bolts and brake components.

! Do not park up your vehicle for a long period of time immediately after cleaning, particularly after cleaning the wheel rim with wheel cleaner. Wheel cleaner may lead to increased corrosion of the brake discs and pads. You should therefore drive for a few minutes after cleaning. By heating up the brakes, the brake discs and pads dry. The vehicle can then be parked up for a long period of time.

- ▶ Clean the wheels with an acid-free cleaning agent.

Cleaning the windows and windscreen wipers

Cleaning the windows

WARNING

If the windscreen wipers are set in motion when cleaning the windscreen or wiper blades, you could become trapped. There is a danger of injury.

Always switch off the windscreen wipers and the ignition before cleaning the windscreen or wiper blades.

- ▶ Place the wiper arms in the vertical position and fold them away from the window.
- ▶ Clean the inside and outside of the windows with a damp cloth and a cleaning agent recommended for smart.
- ▶ Clear deposits regularly from the windscreen and rear window to ensure that water can drain unhindered.

Cleaning the window wiper blades

- ▶ Place the wiper arms in the vertical position and fold them away from the window.
- ▶ Clean the window wiper blades with a soft cloth.
- ▶ Fold the wiper arms back into place.

Cleaning the panoramic roof

! Only use cleaning agents or cleaning cloths that are suitable for plastic lenses. Unsuitable cleaning agents or cleaning cloths could scratch or damage the plastic panes of the panorama roof. Do not use cleaning agents containing solvents

- ▶ Apply mild cleaning agent for plastic windows and wipe off with a moist sponge.

Cleaning the roof

Dry cleaning

- ▶ Brush from the front to the back using a soft brush.

Wet cleaning

- ▶ Dry clean first.
- ▶ Wash down with a soft brush or sponge and lukewarm water.
- ▶ Rinse with clean water.

Cleaning the exterior lighting

- ▶ Apply mild cleaning agent for plastic lenses and wipe off with a wet sponge.

Cleaning and caring for paintwork

! Do not affix stickers to the painted surface. Adhesive residue could damage the paintwork.

- ▶ Remove impurities immediately by rubbing carefully.
- ▶ Soak insect remains with insect remover and rinse off.
- ▶ Soak bird droppings with water and rinse off.
- ▶ Use tar remover to remove tar stains.
- ▶ Use silicone remover to remove wax.
- ▶ Remove coolant, brake fluid, tree resin, oils, fuels and greases by rubbing carefully with a cloth soaked in petroleum ether or lighter fluid.

Cleaning the vehicle interior

Cleaning the displays

! For cleaning, do not use any of the following:

- alcohol-based thinner or petrol
- abrasive cleaning agents
- commercially-available household cleaning agents

These may damage the display surface. Do not put pressure on the display surface when cleaning. This could lead to irreparable damage to the display.

- ▶ Switch off the display and let it cool down.
- ▶ Clean the display surface with a microfibre cloth and cleaner for TFT or LCD displays.
- ▶ Dry the display surface using a dry microfibre cloth.

Cleaning the steering wheel and the selector lever

- ▶ Wipe off with a moist cloth, or use a leather care agent recommended for smart.

Cleaning the seat belts

WARNING

Seat belts may be severely weakened if bleached or coloured. This may lead to the seat belts, for example, tearing or failing in an accident. There is an increased risk of injury, possibly even fatal.

Never bleach or colour seat belts.

! Do not clean the seat belts using chemical cleaning agents. Do not dry the seat belts at temperatures above 80 °C or in direct sunlight.

- ▶ Clean the seat belts using only lukewarm soapy water.

Cleaning and caring for seats

Please note

! Do not use microfibre cloths to clean genuine leather or artificial leather covers, as these are too aggressive and, if used often, may damage the cover.

Regular care maintains the appearance and feel of the seats over time.

Cleaning and caring for genuine leather seat covers

- ▶ Wet a cloth with water and clean the seat covers. Do not allow the leather to become soaked.
- ▶ Wipe off with a dry cloth.
- ▶ Apply a leather care agent recommended for smart.

Cleaning synthetic leather seat covers

- ▶ Wet a cloth with detergent water and clean the seat covers.

Cleaning cloth seat covers

- ▶ Wet a microfibre cloth with detergent water.
- ▶ Rub cloth covers with care, cleaning entire sections of the cover.
- ▶ Allow the seat to dry.

Cleaning DINAMICA seat covers

- ▶ Wet a cloth with water.
- ▶ Clean entire sections of the cover.

Cleaning the trim

Cleaning the plastic trim

WARNING

Care products and cleaning agents containing solvents can cause surfaces in the cockpit to become porous. This could result in plastic parts breaking away when the airbags are deployed. There is a danger of injury.

Do not use care products and cleaning agents containing solvents to clean the cockpit.

! Never attach the following to plastic surfaces:

- stickers
- films
- perfume oil container or similar

You could otherwise damage the plastic.

To maintain the appearance of high-quality plastic surfaces, do not allow surfaces to come into contact with cosmetics, insect repellents or sun creams.

- ▶ Clean the plastic trim with a damp cloth.
- ▶ Use care products and cleaning agents recommended for smart to remove heavy soiling.

Cleaning the roof lining

- ▶ Remove heavy soiling using a soft brush or a cleaning agent recommended for smart.

Cleaning the carpets



- ▶ Use carpet and textile cleaning agents recommended for smart.



Cleaning the trim elements

! Do not use solvent-based cleaning agents such as tar remover, wheel cleaners, polishes or waxes. There is otherwise a risk of damaging the surface.

- ▶ Clean the trim elements with a moist microfibre cloth.
- ▶ Use care products and cleaning agents recommended for smart to remove heavy soiling.

Observing service due dates

The  and  indicator lamps in the instrument cluster display are reminders of upcoming service due dates:

- : minor service.
- : major service.

Monochrome display: the indicator lamp flashes for a few seconds after the engine is started. Depending on the operating conditions of the vehicle, the time or distance remaining until the service is due, is also displayed.

The service interval is based on normal operation of the vehicle. Observe the following if the vehicle is operated under arduous conditions or increased loads, e.g. regular city driving with frequent intermediate stops:

- ▶ Carry out service work more often than specified by the service interval.
- ▶ Check the tyres more frequently.

Current information on the type of service can be obtained at a smart centre or a qualified specialist workshop.

Parking up the vehicle

! Please note that if the vehicle is not used for prolonged periods, vehicle damage may occur and the battery may discharge or become damaged.

- ▶ Visit a qualified specialist workshop for a consultation.

Securing the vehicle in the event of an accident or a breakdown

Securing the vehicle

- ❗ When a tyre is damaged, the danger area must be kept clear of all persons.
- ▶ Stop the vehicle away from traffic on solid, non-slippery ground.
- ▶ Switch on the hazard warning lights.
- ▶ Turn the front wheels to the straight-ahead position.
- ▶ Switch off the engine.
- ▶ Passengers should leave the vehicle.
- ▶ Secure the vehicle against rolling away.
- ▶ Set up the warning triangle.

In the event of a flat tyre, without TIREFIT the vehicle cannot be made roadworthy again using the on-board equipment. No emergency call can be made via the smart Audio-System. The vehicle owner and the driver of the vehicle are responsible for equipping the vehicle with an appropriate breakdown kit and seeking assistance in the event of a breakdown.

Switching the hazard warning lamps on and off

When the hazard warning lamps are switched on, all the turn signal lamps flash. The hazard warning lamps automatically switch on in the following cases:

- an airbag is deployed.
- the vehicle decelerates rapidly from a speed of above 70 km/h and comes to a standstill.

The hazard warning lamps switch off automatically if a speed of 10 km/h is exceeded again after full brake application.

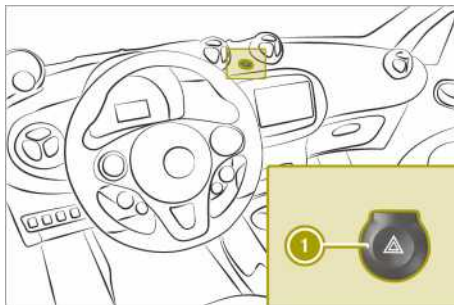

- ▶ To switch on the hazard warning lamps manually: press button ①.

Operating the emergency assistance system

Useful information

For Russia only:

The emergency assistance system is there to rescue you and others in an emergency. Should the driver arrive at the scene of an accident, or feel unwell, an emergency call can be initiated. The emergency call must not be deployed in the case of a breakdown or a similar, non-dangerous situation.

The emergency assistance system can help to radically reduce the time between an accident and the arrival of the emergency services. The requirement is a stable mobile phone connection; network coverage can depend on the region.

If there is no safety risk, in the event of an accident the vehicle occupants should remain in the vehicle after initiating an emergency call.

The emergency assistance system has a separate battery. The battery only functions within a temperature range of -20 °C to 85 °C. The battery must be replaced every four years. Always have work on the battery carried out at a qualified specialist workshop.

Method of operation

After an emergency call has been initiated, the emergency call centre will ascertain if assistance is required on location.

In the event of an emergency, accident data is forwarded to a public emergency call centre.

The data transferred includes:

- GPS/GLONASS position data
- Direction of travel
- Time of initiation

This allows measures for rescue, recovery or towing away to be initiated quickly.

The emergency assistance system consists of a loudspeaker, the control panel and the telecommunication system. The control panel is located in the overhead control panel.

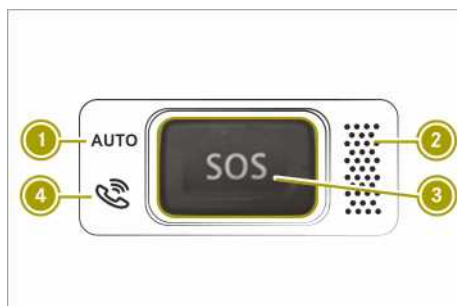

- ① Automatic emergency call indicator lamp
- ② Microphone
- ③ SOS button
- ④ Call and reception status indicator lamp

Using test mode

In test mode, the driver can check if the emergency assistance system is working. To do this, a voice message from the driver is recorded and the test result is transmitted to the emergency call centre.

- ▶ Briefly press SOS button ③ several times within five seconds.
- ▶ Wait for 25 seconds.
- ▶ Briefly press SOS button ③ three times within ten seconds.
A tone sounds. Microphone ② records for ten seconds.
- ▶ Speak any message.
A signal sounds after 25 seconds. The recorded message is played back via the loudspeaker.

- ▶ If the voice message is correctly played back, press and hold SOS button ③ for five seconds.

Indicator lamp ④ flashes green slowly.

or

- ▶ If the voice message is incorrectly played back or not played back at all, press SOS button ③ three times within three seconds.

Indicator lamp ④ flashes red slowly for five seconds.

Automatic emergency call

Indicator lamp ① shows if an automatic emergency call can be initiated.

If airbags are deployed, the emergency assistance system automatically notifies an emergency centre.

- ❗ The automatic emergency call is operational as standard.

Triggering an emergency call manually

Manually initiating an emergency call as a person involved in an accident:

- ▶ Press and hold SOS button ③ for three seconds.
An emergency call is made.

Manually initiating an emergency call after witnessing an accident:

- ▶ Press SOS button ③ five times within ten seconds.
The emergency call centre is informed of the accident.

Securing the vehicle against rolling away

Securing on level ground

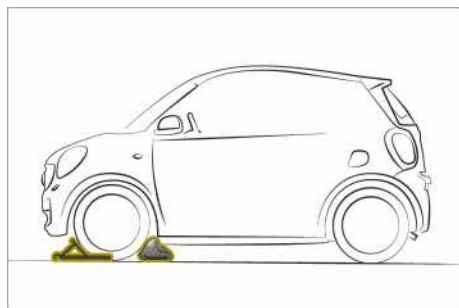

- ▶ When changing a wheel, place chocks or other suitable items under the front and rear of the wheel that is diagonally opposite the wheel you wish to change.

Securing on a downhill gradient

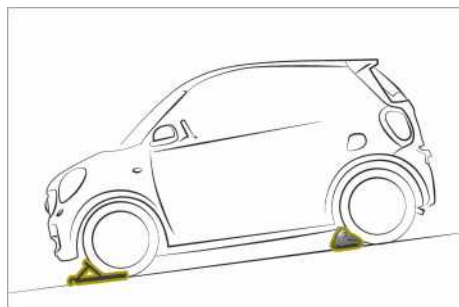

- ▶ Place wheel chocks or other suitable items in front of the wheels of the front and rear axle.

Using the warning triangle

Removing the warning triangle

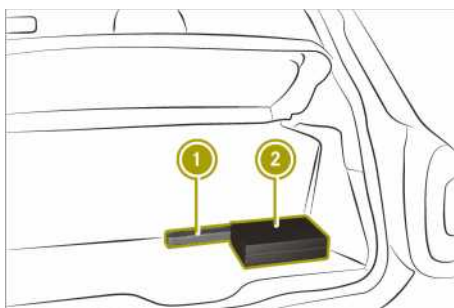

Warning triangle ① is located in the boot behind the seat backrest, secured to the carpet with a Velcro fastener. Return it to this location after use.

- ▶ Remove warning triangle ① from the boot.

Setting up the warning triangle

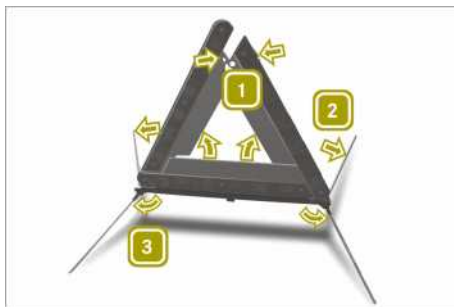

- ▶ Fold feet ③ out to the side.
- ▶ Pull side reflectors ② upwards to form a triangle.
- ▶ Connect the reflectors using upper stud ①.
- ▶ Place the warning triangle at a suitable distance.

Using a reflective safety jacket

Notes on reflective safety jackets

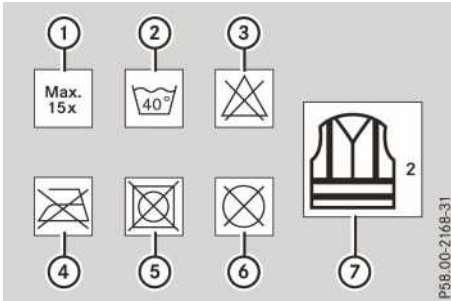

- ① Maximum number of washes
- ② Maximum wash temperature
- ③ Do not bleach
- ④ Do not iron
- ⑤ Do not use a tumble dryer
- ⑥ Do not dry-clean
- ⑦ This is a class 2 jacket

The reflective safety jacket only meets the requirements defined by the legal standard if it is the right size and fully closed when in use.

Replace the reflective safety jacket:

- if it is damaged or there is irremovable dirt on the reflective stripes
- if you exceed the maximum number of washes
- if the fluorescence has faded

Removing the reflective safety jacket

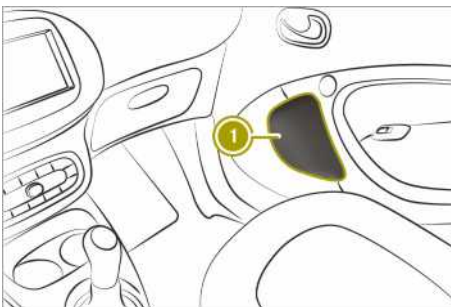

The reflective safety jacket is located in stowage compartment ① of the front-passenger door. Reflective safety jackets can

also be stored in the rear door stowage compartments.

- ▶ **To remove:** take out the safety jacket bag containing the reflective safety jacket.
- ▶ Open the safety jacket bag and take out the reflective safety jacket.
- ▶ **To stow:** fold the reflective safety jacket, roll it up and stow it in the safety jacket bag.
- ▶ Replace the safety jacket bag in stowage compartment ①.

Removing the first-aid kit

- ⓘ Check the expiry date on the first-aid kit at least once a year. Replace the contents if necessary, and replace any missing parts.

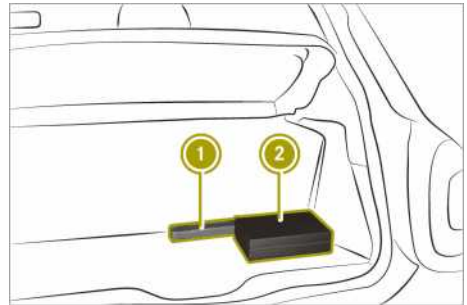

First-aid kit ② is located in the boot behind the seat backrest, secured to the carpet with a Velcro fastener. Return it to this location after use.

- ▶ Remove first-aid kit ② from the boot.

Removing the fire extinguisher

The fire extinguisher is located underneath the front passenger seat.

Removing the vehicle tool tray

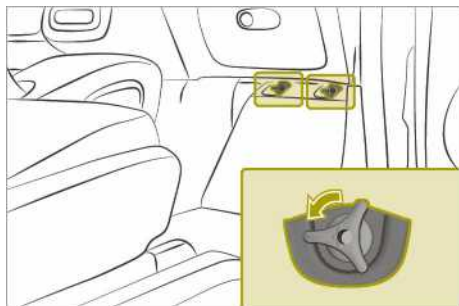

The towing eye and the TIREFIT kit are located in the vehicle tool tray under the glove compartment.

- ▶ Remove bolts in the front-passenger footwell.
- ▶ Remove the vehicle tool tray.

Sealing tyres using the TIREFIT kit

Useful information

The tyre sealant is pumped into the tyre. TIREFIT is a tyre sealant. TIREFIT is used to seal punctures of up to 4 mm, particularly those in the tyre tread, at outside temperatures down to -20 °C.

- ❗ The tyre inflation compressor weighs approximately 0.7 kg.

At a distance of approximately 60 cm from the tyre inflation compressor, the following sound pressure level applies:

- X-axis: 82.9 dB (A)
- Y-axis: 84.3 dB (A)
- Z-axis: 84.1 dB (A)

The tyre inflation compressor is maintenance-free. If there is a malfunction, contact a qualified specialist workshop.

Please note

⚠ WARNING

In the following situations, the tyre sealant is unable to provide sufficient breakdown assistance, as it is unable to seal the tyre properly:

- there are cuts or punctures in the tyre larger than those mentioned above.
- the wheel rim is damaged.
- you have driven at very low tyre pressures or on a flat tyre.

There is a risk of an accident.

Do not drive any further. Contact a qualified specialist workshop.

⚠ WARNING

The tyre sealant is harmful and causes irritation. It must not come into contact with your skin, eyes or clothing or be swallowed. Do not inhale TIREFIT fumes. Keep tyre sealant away from children. There is a risk of injury.

If you come into contact with the tyre sealant, observe the following:

- Rinse off the tyre sealant from your skin immediately with water.
- If the tyre sealant comes into contact with your eyes, immediately rinse them thoroughly with clean water.
- If tyre sealant is swallowed, immediately rinse your mouth out thoroughly and drink plenty of water. Do not induce vomiting, and seek medical attention immediately.
- Immediately change out of clothing which has come into contact with tyre sealant.
- If an allergic reaction occurs, seek medical attention immediately.

⚠ WARNING

A tyre temporarily sealed with tyre sealant impairs the driving characteristics and is

not suitable for higher speeds. There is a risk of accident.

You should therefore adapt your driving style accordingly and drive carefully. Do not exceed the specified maximum speed with a tyre that has been repaired using tyre sealant.

The maximum permissible speed for a tyre sealed with tyre sealant is 80 km/h.

- !** After use, excess tyre sealant may run out of the filler hose. This could cause stains. Therefore, place the filler hose in the plastic bag that contained the TIREFIT kit.

Environmental note

Have the used tyre sealant bottle disposed of professionally, e.g. at a qualified specialist workshop.

Comply with the manufacturer's safety instructions on the sticker on the tyre inflation compressor.

Filling with tyre sealant

- ▶ Leave foreign bodies which have penetrated the tyre in the tyre.
- ▶ Remove the vehicle tool tray.
- ▶ Remove the TIREFIT kit, consisting of a tyre sealant bottle and a tyre inflation compressor, from the vehicle tool kit.
- ▶ Affix the 80 km/h maximum speed sticker to the instrument cluster within the driver's field of vision.



- ▶ Unwind plug (1) with the cable from tyre inflation compressor (2).
- ▶ Remove hose (5) from the bottom section of tyre inflation compressor (2).
- ▶ Unscrew the cap from tyre sealant bottle (4).
- ▶ Connect hose (5).



- ▶ Remove the valve flap from valve (9) on the faulty tyre.
- ▶ Unscrew the cap from filler hose (3).
- ▶ Screw filler hose (3) onto valve (9).
- ▶ Insert connector (1) into the cigarette lighter socket or the 12 V socket.
- ▶ Turn the key to position 1 in the ignition lock.
- ▶ Press on/off switch (6) on tyre inflation compressor (2) to position 1. The tyre sealant is pumped into the tyre. The pressure may briefly rise to approximately 600 kPa (6.0 bar/86 psi) in pressure gauge (7).

- i** Preventing damage to the tyre inflation compressor
- Do not switch off the tyre inflation compressor during this phase.
- ▶ Let the tyre inflation compressor run for a maximum of 15 minutes, then allow it to cool down.

The tyre pressure must be at least 180 kPa (1.8 bar/26 psi) in pressure gauge (7).

Allow any leaking tyre sealant to dry. It can then be removed like a layer of film.

Have any clothing stained with tyre sealant cleaned as soon as possible with perchloroethylene.

Further procedure if the pressure of the sealed tyre is below 180 kPa

WARNING

If the specified tyre pressure still cannot be reached, the tyre is too badly damaged. The tyre sealant cannot repair the tyre in this instance. Damaged tyres and low tyre pressures can significantly impair the vehicle's braking and driving characteristics. There is a risk of an accident.

Do not drive any further. Contact a qualified specialist workshop.

- ▶ Switch off the tyre inflation compressor.
- ▶ Unscrew the filler hose from the valve of the defective tyre.
Please note that tyre sealant may escape when unscrewing.
- ▶ Slowly move the vehicle approximately 10 m forwards or backwards.
- ▶ Pump up the tyre again.
After a maximum of 15 minutes, the tyre pressure must be at least 180 kPa (1.8 bar, 26 psi).

Further procedure if the pressure of the sealed tyre is at least 180 kPa

- ▶ Switch off the tyre inflation compressor.
- ▶ Unscrew the hose from the valve of the defective tyre.
Please note that tyre sealant may escape when unscrewing.
- ▶ Stow the tyre sealant bottle and the tyre inflation compressor.
- ▶ Perform a test drive.
The maximum permissible speed for a tyre sealed with tyre sealant is 80 km/h.
- ▶ Stop after driving for approximately 3 km and check the tyre pressure with the tyre inflation compressor.
The tyre pressure must now be at least 130 kPa (1.3 bar/19 psi). The precise values are located on the door pillar (B-pillar) on the driver's side.
- ▶ If necessary, adjust the tyre pressure.
- ▶ Unscrew the filler hose from the valve on the sealed tyre.

Please note that tyre sealant may escape when unscrewing.

- ▶ Screw the valve cap onto the valve of the sealed tyre.
- ▶ Pull the tyre sealant bottle out of the tyre inflation compressor. The filler hose stays on the tyre sealant bottle.
- ▶ Drive to the nearest qualified specialist workshop and have the tyre changed there.
- ▶ Have the tyre sealant bottle and filler hose replaced as soon as possible at a qualified specialist workshop.

Adjusting the tyre pressure

Increasing the tyre pressure

- ▶ Switch on the tyre inflation compressor.
- ▶ Observe the display.

Reducing the tyre pressure



- ▶ Press button ① next to pressure gauge ②.
- i** Even unused tyre sealant loses its effectiveness over time.
Have the tyre sealant bottle replaced every four years at a qualified specialist workshop.

Towing the vehicle

Please note

WARNING

Safety relevant functions are restricted or no longer available if:

- the ignition is switched off
- the brake system or power steering is malfunctioning
- there is a malfunction in the voltage supply or the vehicle's electrical system.

When your vehicle is towed, you may require considerably more effort to steer and brake. There is a risk of an accident.

In such cases use a rigid towing bar. Before towing away, make sure the steering moves freely.

WARNING

If the steering wheel lock is engaged, the vehicle can no longer be steered. There is a risk of an accident.

Always switch on the ignition when towing with a tow rope or a towing bar.

WARNING

When towing or tow-starting another vehicle and its weight is greater than the permissible gross weight of your vehicle, the:

- towing eye may be torn off
- car/trailer combination may swerve or even overturn

There is a risk of an accident.

When towing or tow-starting another vehicle, its weight should not be greater than the permissible gross weight of your vehicle.

Information on the vehicle's permissible gross weight can be found on the vehicle identification plate (▷ page 207).

 Observe the following points when towing with a tow rope:

- secure the tow rope on the same side on both vehicles.
- make sure that the tow rope is not longer than legally permitted. Mark the tow rope in the middle, e.g. with a white cloth (30 x 30 cm). This makes other road users aware that a vehicle is being towed.
- only secure the tow rope to the towing eye.
- observe the brake lamps of the towing vehicle while driving. Always maintain a distance so that the tow rope does not sag.
- do not use steel cables or chains to tow your vehicle. You could otherwise damage the vehicle.

 Do not use the towing eyes for recovery purposes as this could damage the vehicle. If in doubt, recover the vehicle with a crane.



 When towing, pull away slowly and smoothly. If the tractive power is too high, the vehicles could be damaged.

 You may tow the vehicle for a maximum of 50 km. A towing speed of 50 km/h must not be exceeded.

For towing distances over 50 km, the entire vehicle must be lifted up and transported.

Observe the legal requirements for the relevant countries when towing.

Always have the vehicle transported in the following cases:

- The  warning lamp lights up and **Do not tow vehicle with wheels on ground** appears in the display of the instrument cluster.
- The multifunction display is not working.
- One or more of the following warning lamps is lit up:
 -  drive diagnostics (red)
 -  12 V battery
- The brake pedal begins to pulsate as soon as the towing procedure commences.
- The vehicle must be moved over a long distance.

The transmission must be in position  when the vehicle is being towed.

i Before the vehicle is towed, switch off the automatic locking feature. The driver could otherwise be locked out when pushing or having the vehicle towed.

i Vehicles with the basic carrier fitted:

Do not tow the vehicle with the basic carrier fitted.

Do not secure the tow rope or tow bar to the basic carrier.

Observe the notes on the selector lever when towing the vehicle.

Fitting the towing eye

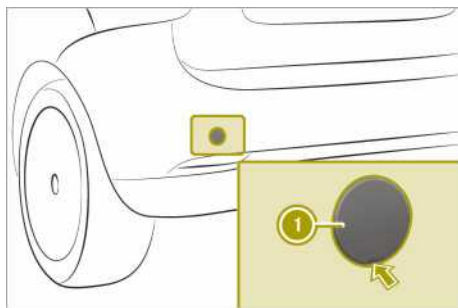
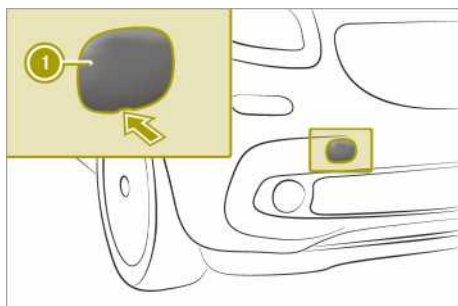

The towing eye can be attached to the front or rear of the vehicle.

- ▶ Remove the towing eye from the vehicle tool tray.
- ▶ Carefully prise off cover ① on the vehicle.
- ▶ Screw in the towing eye to the stop.

Towing the vehicle with both axles on the ground

- ▶ Turn the key to position ② in the ignition lock.
- ▶ Depress the brake pedal and keep it depressed.
- ▶ Shift the automatic transmission to position **N**.
The selector lever lock can be manually released in the event of an electrical malfunction.
- ▶ Release the brake pedal.
- ▶ Release the parking brake.
- ▶ Switch on the hazard warning lights.

Transporting the vehicle

! Only secure the vehicle by the wheels or rims, not by parts of the vehicle such as the axle or steering components. Otherwise the vehicle could be damaged.

- ▶ Turn the key to position ② in the ignition lock. Shift the transmission to position **N**.

As soon as the vehicle is loaded:

- ▶ Apply the parking brake.
- ▶ Shift the transmission to position **P**.
- ▶ Remove the key.
- ▶ Lash down the vehicle.

Removing the towing eye

- ▶ Loosen the towing eye and unscrew it.
- ▶ Attach the cover to the recess at the top and engage it at the bottom.
- ▶ Stow the towing eye in the vehicle tool tray.

Manually releasing the selector lever lock

In cases of an electrical fault the selector lever lock can be manually deactivated, e.g. if the parking lock has been deactivated for towing and should subsequently be re-applied.

! Do not use any sharp-edged objects to prise out the cover from the centre console. Otherwise, the cover or the centre console could be damaged.

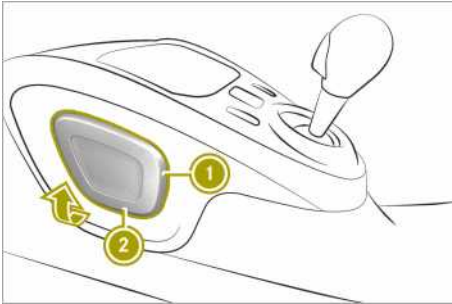

- ▶ Apply the parking brake.
- ▶ Open the drawer on the front-passenger side.
- ▶ Prise out cover ① on the centre console from bottom edge ② using with a flat, blunt object.
- ▶ Pull cover ① in the direction of the arrow.

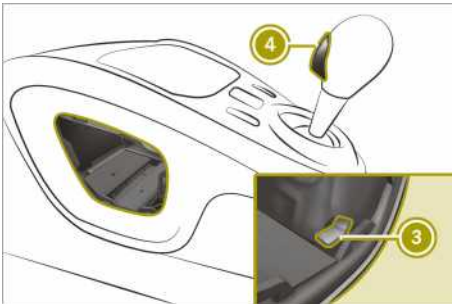

- ▶ Pull yellow release ③ behind the trim up and simultaneously press release button ④ on the selector lever.
- ▶ Shift the gear selector lever to position **N** or **P**.

Replacing the bulbs

Please note

⚠ WARNING

Bulbs, lamps and plug connectors can become very hot during use. When replac-

ing a bulb, you could burn yourself on these components. There is a risk of injury. Allow these components to cool down before replacing the bulb.

Observe the following rules when replacing bulbs:

- Only replace bulbs when the engine is switched off.
- Do not use bulbs that have been dropped or show signs of visible damage, e.g. scratches.
- Do not touch the glass bulb with your bare hands.
- Only use bulbs in enclosed lamps designed for that purpose.
- Only fit spare bulbs of the same type and with a specified voltage.
- Do not allow bulbs to come into contact with moisture.
- Have LEDs changed at qualified specialist workshops only.

Change only the bulbs described below yourself in accordance with the specified bulb types.

Replacing front bulbs

Changing dipped-beam and main-beam headlamps

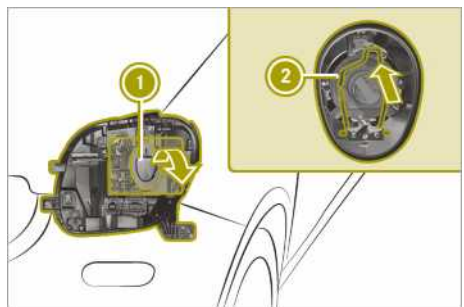

- ▶ Switch off the lights.
- ▶ Open the service cover.
- ▶ Remove cover ①.
- ▶ Pull out the connector.
- ▶ Press retainer ② inwards and to the left.
- ▶ Pull the bulb out.

- ▶ Insert the new bulb.
- ▶ Lock retainer ②.
- ▶ Insert the connector.
- ▶ Replace and engage cap ①.

Replacing the front turn signal lamps

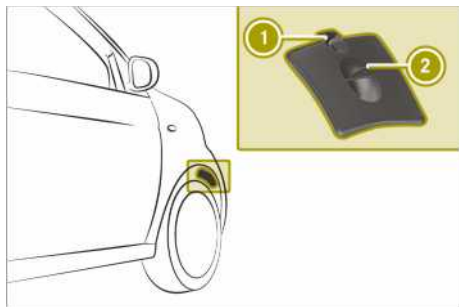

- ▶ Switch off the lights.
- ▶ Turn the respective front wheel inwards.
- ▶ Push clamp ① downwards.
- ▶ Remove cover ② upwards.
- ▶ Turn the bulb holder anti-clockwise and remove it.
- ▶ Remove the bulb from the bulb holder.
- ▶ Insert the new bulb.
- ▶ Insert the bulb holder and turn it clockwise until it engages.
- ▶ Insert and engage cover ②.

Replacing the side turn signal lamps

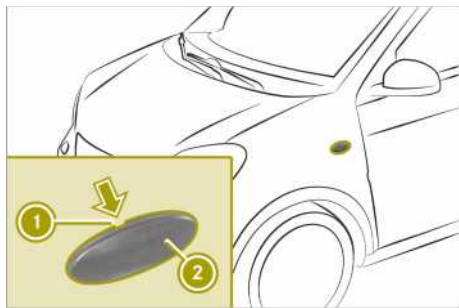

- ▶ Carefully insert a flat tool into recess ①.
- ▶ Prise out side turn signal ②.
- ▶ Turn bulb holder in side turn signal ② 90° anti-clockwise and remove it.

- ▶ Remove the bulb from the bulb holder.
- ▶ Insert the new bulb into the bulb holder.
- ▶ Insert the bulb holder into side turn signal ② and turn it 90° clockwise.
- ▶ Refit side turn signal ②.

Replacing rear bulbs

Replacing the tail lamp bulbs

Tail lamps without partial LEDs

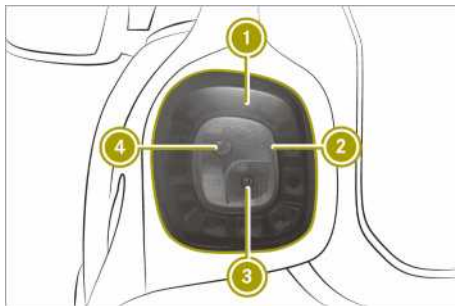

- ① Rear/brake lamp
- ② Rear fog lamp
- ③ Reversing lamp
- ④ Turn signals

Tail lamps with partial LEDs

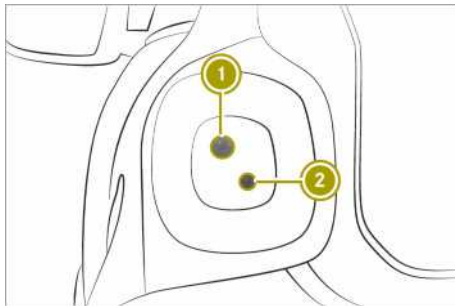

- ① Turn signals
- ② Reversing lamp

Removing the tail lamp cover

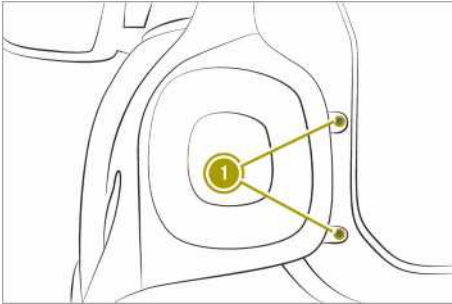

- ▶ Switch off the lights.
- ▶ Open the tailgate.
- ▶ Loosen screws ①.
- ▶ Remove the tail lamp.
- ▶ Carefully insert a flat tool under the plastic hanger on the tail lamp.
- ▶ Lift the connector and remove it.

Replacing a faulty tail lamp bulb

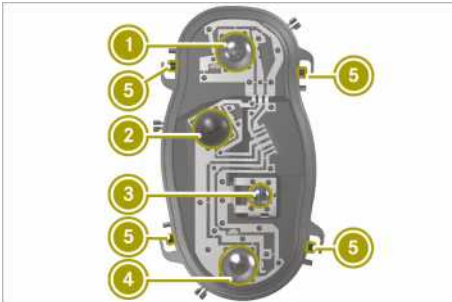

- ① Rear lamp/brake lamp (vehicles without partial LEDs)
- ② Turn signals
- ③ Reversing lamp
- ④ Rear fog lamp (vehicles without partial LEDs)
- ▶ Release four tabs ⑤ on the bulb holder.
- ▶ Remove the bulb holder.
- ▶ Pull the faulty bulb out.
- ▶ Insert the new bulb.
- ▶ Refit the bulb holder.
- ▶ Insert the connector.
- ▶ Insert the tail lamp until you hear it engage.
- ▶ Tighten the screws on the tail lamp.

Replacing the licence plate lighting



- ▶ Insert a flat tool into recess ①.
- ▶ Remove the cover from the licence plate lamp.
- ▶ Remove the bulb from the holder.
- ▶ Insert the new bulb into the holder.
- ▶ Insert the lamp lens into the licence plate lamp.

Replacing the interior lighting

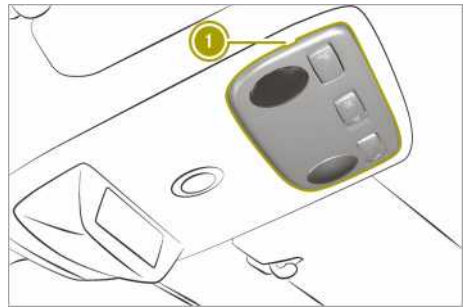

- ▶ Insert a flat tool into the recess.
- ▶ Prise out lamp lens ①.
- ▶ Remove the bulb from the holder.
- ▶ Insert the new bulb into the holder.
- ▶ Refit the lamp lens.

Changing fuses

Please note

⚠ WARNING

If you manipulate, bridge or replace a faulty fuse with a fuse of a higher amper-

age, the electric cables could be overloaded. This may result in a fire. There is a risk of an accident and injury.

Always replace faulty fuses with specified new fuses of the correct amperage.

! Only use fuses that have been approved for smart vehicles and which have the correct fuse rating for the system concerned. Components or systems could otherwise be damaged.

! Make sure that no moisture can enter the fuse box when the cover is open.

The electrical fuses disconnect defective circuits. If a fuse blows, all the connected components and their functions will fail.

Blown fuses must be replaced with fuses of the same rating, which you can recognise by the colour and fuse rating. The fuse ratings are listed in the fuse allocation chart (▷ page 210).

If new fuses blow, the cause for this must be diagnosed and rectified at a qualified specialist workshop.

Preparing the vehicle to change a fuse

- ▶ Apply the parking brake.
- ▶ Switch off all electrical consumers.
- ▶ Turn the key to position **0** in the ignition lock and remove it.
- ▶ Check whether all indicator lamps in the instrument cluster are off.

Replacing a fuse (left-hand drive vehicle)

! Do not use a pointed object such as a screwdriver to open the cover in the dashboard. You could damage the dashboard or the cover.

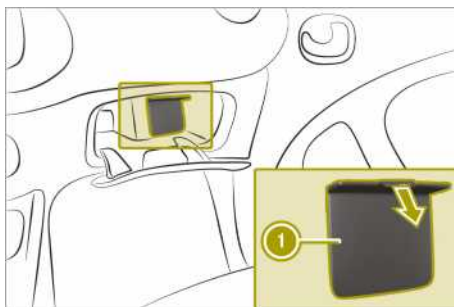

- ▶ Open the front-passenger door.
- ▶ Open the glove compartment.
- ▶ To open: open cover ① in the direction of the arrow.
- ▶ Replace the faulty fuse.
- ▶ To close: insert and fold in cover ① until it engages.
- ▶ Close the glove compartment.

Replacing a fuse (right-hand drive vehicle)

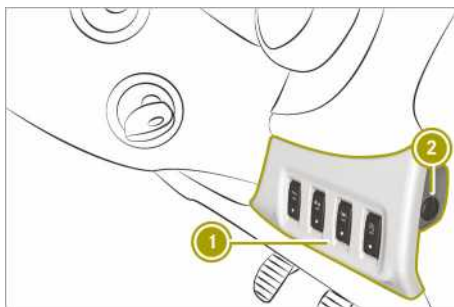

- ▶ Open the driver's door.
- ▶ To open: turn quick-release fastener ② by 90° using a suitable object.
- ▶ Fold down cover ①.
- ▶ Replace the faulty fuse.
- ▶ To close: close cover ①.
- ▶ Close quick-release fastener ②.

Replacing the key battery

⚠ WARNING

Batteries contain toxic and corrosive substances. If batteries are swallowed, it can result in severe health problems. There is a risk of fatal injury.

Keep batteries out of the reach of children. If a battery is swallowed, seek medical attention immediately.

♻ Environmental note



Batteries contain pollutants. It is illegal to dispose of them with the household rubbish. They must be collected separately and disposed of in an environmentally responsible recycling system.



Dispose of batteries in an environmentally responsible manner. Take discharged batteries to a qualified specialist workshop or to a collection point for used batteries.

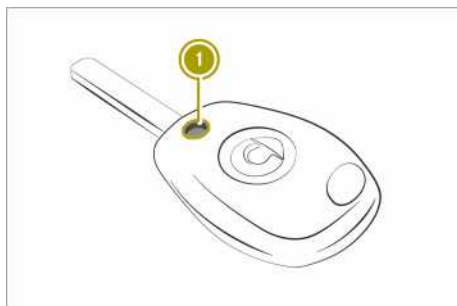

- ▶ **Fixed keys:** unscrew screw ①.

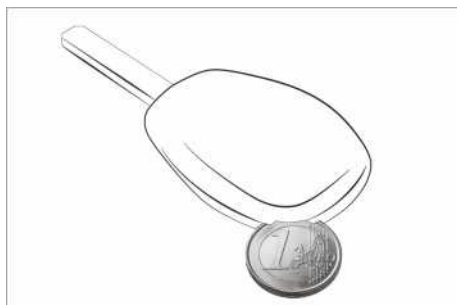

- ▶ Insert a flat tool, e.g. a coin, into the recess.
- ▶ Turn the tool until the cover of the battery tray opens.

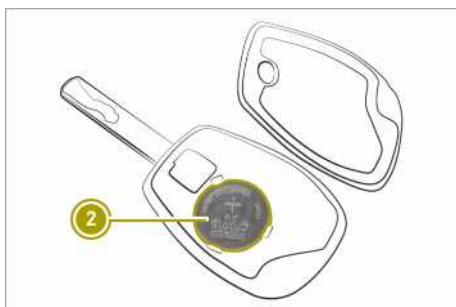

- ▶ Replace battery ② with the positive terminal facing upwards.
- ▶ Replace the cover on the battery tray and push it closed.
- ▶ **Fixed keys:** screw in screw ①.
- ▶ Check the function of all key buttons.

Opening a door with the emergency release

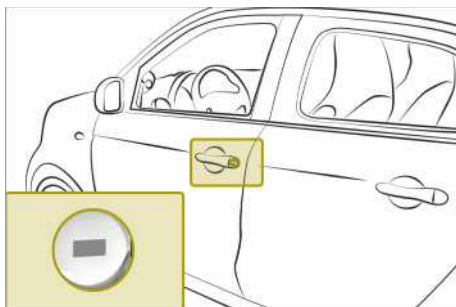

If the vehicle cannot be opened using the remote control key, the vehicle can be opened using the emergency release.

If the driver's door is unlocked and opened with the key in the emergency release, the anti-theft alarm system will issue an alarm. To disable the alarm, switch on the ignition.

- ▶ Insert the key into the emergency release on the driver's door.
- ▶ Turn the key anti-clockwise.
- ▶ Remove the key from the lock.
- ▶ Open the door.
- ▶ To disable the alarm from the anti-theft alarm system: switch on the ignition.

On right-hand-drive vehicles, the emergency release is located on the front-passenger door.

Locking the doors in an emergency

Locking the doors with the locking button

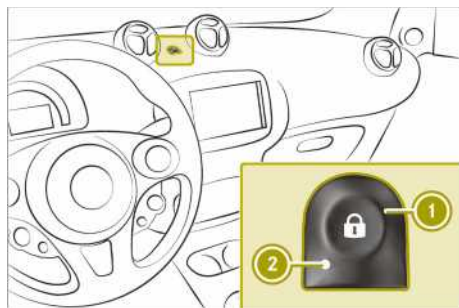

- ▶ Open the driver's door.
- ▶ Close the other doors and the tailgate.
- ▶ Press and hold button ①. An audible locking and unlocking sound can be heard. Wait until the third (locking) sound, before releasing button ①.
- ▶ Leave the vehicle and close the driver's door.

The doors, tailgate and socket cap are locked. The anti-theft alarm system is primed.

- ▶ From the outside, check that the doors, tailgate and socket cap are locked.

Locking the doors with the emergency locking

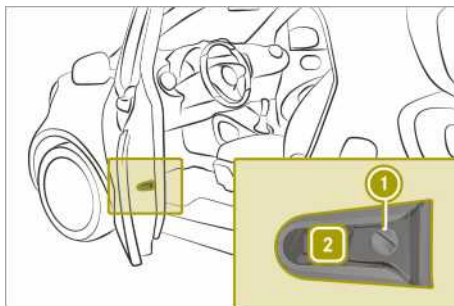

- ▶ Insert the key into slot ① on the left door.
- ▶ Turn the key towards the bonnet as far as it will go to position ②.
- ▶ Close the left door.
- ▶ Repeat the procedure described above on the right door.
- ▶ Check that the doors are locked.

i If you lock the vehicle using emergency locking, the tailgate and socket cap are not locked. The anti-theft alarm system is not primed.

Unlocking the tailgate with the emergency release

- ⚠ The tailgates swing to the rear, both upwards and downwards, when opened. Therefore, make sure that there is sufficient clearance above, behind and below the tailgates.

If the tailgate can no longer be opened from outside the vehicle, it can be opened from the inside using the emergency release.

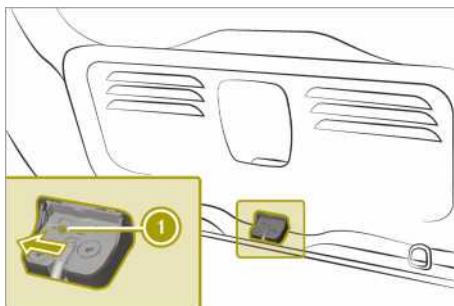

- ▶ Fold the rear seat backrest forward.
- ▶ Slide lever ① on the tailgate to the left until the tailgate is unlocked.

Notes on display messages



The display shows warnings, malfunctions or additional information. A warning tone also sounds with some display messages. Messages from all categories can contain important information that must be observed. Have error messages checked at a Mercedes-Benz Service Centre as soon as possible. If an error message is not followed up with a repair, this can lead to damage that is not covered by the Mercedes-Benz Limited Warranty including injuries or material damage.

Display messages with graphic symbols are simplified in the Owner's Manual and may differ from the symbols in the display.



Colour display: low-priority display messages can be hidden by pressing **[OK]** on the steering wheel. High-priority messages are shown in red. The display messages are then stored in the message memory and can be called up for as long as the ignition remains switched on. Switching off the ignition clears the message memory.





Locking and unlocking

Problem	Possible causes/consequences and ► Solutions
Key will not lock or unlock the vehicle.	A strong source of radio waves is interfering with the signal. ► Stand closer to the door lock and try to lock/unlock the vehicle again.
	Key battery is low or discharged. ► Unlock the vehicle with the key in the emergency release or lock the vehicle with emergency locking. ► Replace the key battery.
	Key is faulty. To lock: ► Press the locking button and close the door within five seconds. The vehicle still will not lock. ► Lock driver's door using emergency locking. ► Consult a qualified specialist workshop. To unlock: ► Unlock vehicle with the key in the emergency release. ► Consult a qualified specialist workshop.
Key is lost.	► Have the key deactivated or replaced at a qualified specialist workshop. ► Report loss of the key to vehicle insurer.
Warning tone sounds.	Driver's door is opened while the engine is running. Switch off the engine before leaving the vehicle: ► Apply the parking brake. ► Select transmission position [P] . ► Turn the key to position [0] in the ignition lock and remove it.







Problem	Possible causes/consequences and ► Solutions
<p>Side window will not close or will not open or close fully.</p>	<p>Objects are obstructing the window guide.</p> <ul style="list-style-type: none"> ► Remove objects. <p>Side window is not reset.</p> <p> WARNING</p> <p>While closing the side windows, body parts in the closing area could become trapped. There is a risk of injury.</p> <p>When closing make sure that no parts of the body are in the closing area. If somebody becomes trapped, release the switch or press the switch to open the side window again.</p> <ul style="list-style-type: none"> ► Close all doors. ► Turn the key to position 2 in the ignition lock. ► Pull the switch for closing the window until the window is closed, and then push the switch for one second. <p>The side window opens again a little way.</p> <ul style="list-style-type: none"> ► Repeat previous step until the window remains closed after releasing the switch.
<p>Folding top will not close.</p>	<p>Folding top is obstructed during closing and reopens again slightly.</p> <ul style="list-style-type: none"> ► Immediately after it is obstructed, press the top part of the folding top switch again until the folding roof is fully closed. Folding top is closed with increased force.
<p> Red warning lamp is lit. If the speed exceeds 20 km/h, a warning tone also sounds. Colour display: the display shows an open door/tailgate.</p>	<p>Door or tailgate is open.</p> <ul style="list-style-type: none"> ► Pull over and stop the vehicle, paying attention to road and traffic conditions. ► Close all doors and the tailgate.











Vision, vehicle occupants, airbag





Problem	Possible causes/consequences and ► Solutions
The exterior mirror is not engaged.	The exterior mirror has been moved forwards or backwards by force. ► Carefully move the exterior mirror to the correct position.
The windscreen wipers have malfunctioned.	The windscreen wipers are obstructed, e.g. by snow. ► Pull over and stop the vehicle, paying attention to road and traffic conditions. ► Remove the key from ignition lock. ► Remove the cause of the obstruction. ► Switch the windscreen wipers on again after 30 seconds. The windscreen wiper drive is malfunctioning. ► Select another wiper speed on the combination switch. ► Consult a qualified specialist workshop.
The windscreen wipers will not stop or always wipe at the same speed.	The combination switch or rain sensor is malfunctioning. ► Pull over and stop the vehicle, paying attention to road and traffic conditions. ► Remove the key from ignition lock. ► Insert the key into the ignition lock, turn to position 1 and start the engine. ► Consult a qualified specialist workshop.
The red  warning lamp lights up for 6 seconds after starting the engine (certain countries only). A warning tone sounds.	The warning lamp prompts the driver and front passenger to fasten their seat belts. ► Fasten the seat belts.
The red  warning lamp lights up after starting the engine.	The driver or front passenger has not fastened their seat belt. ► Fasten the seat belts.
The red  warning lamp flashes. A warning tone sounds.	The driver or front passenger has not fastened their seat belt and the vehicle is travelling faster than 20 km/h. ► Fasten the seat belts.

Problem	Possible causes/consequences and ► Solutions
<p>The red  warning lamp lights up while the engine is running.</p> <p>Colour display: Malfunction Visit workshop appears.</p>	<p>The restraint system is malfunctioning.</p> <p> WARNING</p> <p>If the restraint system is malfunctioning, restraint system components may be triggered unintentionally or may not deploy as intended during an accident. This may affect the seat belt tensioner or airbag, for example. This poses an increased risk of injury or even fatal injury.</p> <p>Have the restraint system checked and repaired immediately at a qualified specialist workshop.</p>
<p>The  indicator lamp on the overhead control panel lights up.</p>	<p>The front-passenger front airbag has been disabled (▷ page 41).</p> <p>► Enable the front-passenger front airbag.</p> <p>The front-passenger front airbag has not been disabled and is malfunctioning.</p> <ul style="list-style-type: none"> ► Do not use a rearward-facing child restraint system on the front-passenger seat. ► Do not allow passengers to travel on the front-passenger seat. ► Consult a qualified specialist workshop.
<p>The  indicator lamp on the overhead control panel lights up.</p>	<p>Front-passenger front airbag is enabled (▷ page 41). The airbag system is operating correctly.</p> <ul style="list-style-type: none"> ► Do not use a rearward-facing child restraint system on the front-passenger seat.
<p>The  indicator lamp on the overhead control panel does not light up if the front-passenger front airbag has been enabled manually.</p>	<p>There is a malfunction in the airbag system.</p> <ul style="list-style-type: none"> ► Do not allow passengers to travel on the front-passenger seat. ► Consult a qualified specialist workshop.

Engine, brakes, transmission



Problem	Possible causes/consequences and ► Solutions
The engine will not start using the key.	The steering lock is manually locked. <ul style="list-style-type: none"> ► Remove the key from the ignition lock and then reinsert it into the ignition lock. ► Turn the key. ► Turn the steering wheel left and right.
The red  warning lamp lights up. A warning tone sounds. Without starting motor again, visit workshop appears.	There is a serious malfunction in the high-voltage electrical system. The engine can no longer be started. <ul style="list-style-type: none"> ► Do not restart the engine. ► Consult a qualified specialist workshop.
The red  warning lamp lights up. Stop Switch off motor appears.	The high-voltage electrical system, engine or high-voltage battery is malfunctioning. <ul style="list-style-type: none"> ► Switch off the engine. ► Do not drive on. ► Consult a qualified specialist workshop. ► Do not tow away the vehicle on its own wheels.
The red  warning lamp lights up. A warning tone sounds. Stop appears.	Communication with the engine's control unit is malfunctioning. <ul style="list-style-type: none"> ► Switch off the engine. ► Do not drive on. ► Consult a qualified specialist workshop. ► Do not tow away the vehicle on its own wheels.
The yellow  warning lamp lights up. A warning tone sounds. Malfunction Visit workshop appears.	There is a malfunction in the high-voltage electrical system. The vehicle's high-voltage electrical system may become damaged if you continue running the engine. <ul style="list-style-type: none"> ► Switch off the engine. ► Do not drive on. ► Consult a qualified specialist workshop. ► Do not tow away the vehicle on its own wheels.
The red  warning lamp lights up. A warning tone sounds. Reduce speed appears.	The speed of the vehicle is above 135 km/h. <ul style="list-style-type: none"> ► Reduce the speed to below 135 km/h.
 lights up. Do not tow vehicle with wheels on ground appears.	The drive system or high-voltage electrical system is faulty. <ul style="list-style-type: none"> ► Have the vehicle transported by a qualified specialist workshop. ► Do not tow away the vehicle on its own wheels.





Problem	Possible causes/consequences and ► Solutions
<p>The red  warning lamp lights up while the engine is running.</p> <p>A warning tone sounds.</p> <p>Colour display: <i>Check brake fluid level</i> appears.</p>	<p>Brake fluid level is too low.</p> <p> WARNING</p> <p>If the brake fluid level is too low the brake system may fail. There is a risk of an accident.</p> <p>Stop the vehicle in accordance with the traffic conditions. Secure the vehicle by applying the parking brake. Do not drive any further. Consult a qualified specialist workshop immediately and have the brake system repaired.</p> <p>Do not top up the brake fluid, as this will not rectify the fault.</p> <p>► Consult a qualified specialist workshop.</p>
<p>The red  warning lamp lights up while driving.</p> <p>A warning tone sounds.</p> <p>Colour display: <i>Release parking brake</i> appears.</p>	<p>The parking brake is applied.</p> <p>► Release the parking brake.</p>
<p>The red  warning lamp lights up while the engine is running.</p> <p>A warning tone sounds.</p> <p>Colour display: <i>Brake system malfunction Stop</i> appears.</p>	<p>There is a serious malfunction in the brake system.</p> <p>► Consult a qualified specialist workshop.</p>
<p>The yellow  warning lamp lights up.</p> <p>Colour display: <i>Malfunction Visit workshop</i> appears.</p>	<p>There is a malfunction in the vacuum supply of the brake system.</p> <p>► Consult a qualified specialist workshop.</p>
<p>Monochrome display:  or  flash alternately in the middle of the display.</p> <p>Colour display: <i>To start engine: shift to P or N</i> appears.</p>	<p>An attempt was made to start the engine with the transmission in position  or .</p> <p>► Shift to  or  to start.</p>

Problem	Possible causes/consequences and ► Solutions
<p>Monochrome display: P or D/R, N flash alternately.</p> <p>A warning tone sounds.</p> <p>Colour display: Risk of vehicle rolling away Transmission not in P appears.</p> <p>A warning tone sounds.</p>	<p>The driver's door is open and the selector lever is in position R, N or D.</p> <p> WARNING</p> <p>The vehicle may roll away. There is a risk of an accident.</p> <ul style="list-style-type: none"> ► Shift to position P. ► Switch off the engine. ► Close the driver's door completely.
<p> or  warning lamp flashes for a few seconds after starting the engine.</p> <p>Colour display: Next service due in ... km or Service due ... days ago appears.</p>	<p>A service due date is approaching or has already passed:</p> <ul style="list-style-type: none"> •  indicates a minor service. •  indicates a full service. <p>► Consult a qualified specialist workshop.</p>





Charging process







Problem	Possible causes/consequences and ► Solutions
The charge socket flap cannot be opened.	<p>The charge socket flap is not unlocked.</p> <ul style="list-style-type: none"> ► Press the  button on the key.
	<p>The key batteries are discharged.</p> <ul style="list-style-type: none"> ► Opening a door with the emergency release
The charging cable cannot be plugged into the vehicle socket.	<p>The vehicle socket is locked.</p> <ul style="list-style-type: none"> ► Make sure that the selector lever is in position P.
The indicator lamp on the vehicle socket flashes red. The high-voltage battery is not being charged.	<p>A fault occurred while initializing the charging process.</p> <ul style="list-style-type: none"> ► Make sure that the charging cable is plugged into the mains socket. ► Disconnect the charging cable connector from the vehicle socket and plug it back into the vehicle socket after 30 seconds. ► If the malfunction should persist, inform a qualified specialist workshop.



Problem	Possible causes/consequences and ► Solutions
<p>The indicator lamp on the vehicle socket remains off after the charging cable connector has been connected to the vehicle socket. When charging using a mains socket, the high-voltage battery is not charged.</p>	<p>There is a malfunction at the mains socket.</p> <ul style="list-style-type: none"> ► Have the mains socket checked to ensure that it is working correctly. <p>or</p> <ul style="list-style-type: none"> ► Use a different mains socket.
<p> lights up. Warning tone sounds. Charger cable connected appears.</p>	<p>The charging cable is plugged into the vehicle socket. The engine cannot be started.</p> <ul style="list-style-type: none"> ► Before driving off, disconnect the charging cable from the vehicle socket and stow it away in the vehicle.
<p> flashes. Charging cable not inserted correctly appears.</p>	<p>The charge cable is connected to the vehicle socket. The battery is not being charged.</p> <ul style="list-style-type: none"> ► Make sure that the charging cable is correctly plugged into the sockets on the vehicle and power connection. If necessary, disconnect the charging cable from the sockets and then reconnect it. <p>If the message continues to be displayed:</p> <ul style="list-style-type: none"> ► Consult a qualified specialist workshop.
<p>The charging cable connector cannot be removed from the vehicle socket.</p>	<p>The charging cable connector is not unlocked.</p> <ul style="list-style-type: none"> ► Press the  button on the key. This unlocks the charging cable connector in the vehicle socket. ► Remove charging cable connector from the vehicle socket.
<p>Charging not possible Power supply interrupted appears.</p>	<p>The high-voltage battery cannot be charged. The charge current was interrupted during the charging process.</p> <ul style="list-style-type: none"> ► Make sure that the charging cable is plugged into the mains socket. ► Disconnect the charging cable connector from the vehicle socket and plug it back into the vehicle socket after 30 seconds. <p>If the message continues to be displayed:</p> <ul style="list-style-type: none"> ► Consult a qualified specialist workshop.





Problem	Possible causes/consequences and ► Solutions
<p>Charging not possible s. Owner's Manual appears.</p>	<p>Communication with the charging point infrastructure is not functioning correctly.</p> <ul style="list-style-type: none"> ► Make sure that the charging cable is correctly plugged into the sockets on the vehicle and power connection. If necessary, disconnect the charging cable from the sockets and then reconnect it. <p>If the message continues to be displayed:</p> <ul style="list-style-type: none"> ► Use a different charging station. <p>If the message continues to be displayed:</p> <ul style="list-style-type: none"> ► Consult a qualified specialist workshop.
<p> Yellow warning lamp lights up. Charging not possible Visit workshop appears.</p>	<p>The vehicle electronics are malfunctioning. The high-voltage battery cannot be charged.</p> <ul style="list-style-type: none"> ► Consult a qualified specialist workshop.
<p> Yellow warning lamp lights up. Charging not possible s. Owner's Manual appears.</p>	<p>The high-voltage battery cannot be charged. The charging cable connector is overheated.</p> <ul style="list-style-type: none"> ► Remove the charging cable connector from the vehicle socket. ► Allow the charging cable connector to cool off for several minutes. ► Plug the charging cable back into the vehicle socket. <p>If the message continues to be displayed:</p> <ul style="list-style-type: none"> ► Consult a qualified specialist workshop.
<p>The indicator lamp on the vehicle socket does not light up. The high-voltage battery is not being charged.</p>	<p>The vehicle is inactive.</p> <ul style="list-style-type: none"> ► Activate the vehicle by pressing the  button on the key and lock it again.
<p>The charging cable cannot be removed.</p>	<p>The vehicle is in charging mode or has completed active charging.</p> <ul style="list-style-type: none"> ► Unlock the charging lock by pressing the  button on the key.







Driving safety systems





Problem	Possible causes/consequences and ► Solutions
<p> Yellow warning lamp lights up.</p> <p>Colour display: System inoperative appears.</p>	<p>ABS is malfunctioning. Other driving systems may be deactivated.</p> <p>If ABS is faulty, there is also a possibility that other driving systems may be unavailable.</p> <p>Observe the information on the ABS warning lamp and display messages which may be shown in the instrument cluster.</p> <p> WARNING</p> <p>If ABS is faulty, the wheels could lock when braking. The steerability and braking characteristics may be severely impaired. Additionally, further driving safety systems are deactivated. There is an increased danger of skidding and accidents.</p> <p>Drive on carefully. Have ABS checked immediately at a qualified specialist workshop.</p> <p>When ABS is malfunctioning, other systems, including driving safety systems, will also become inoperative. Observe the information on the ABS warning lamp and display messages which may be shown in the instrument cluster.</p> <ul style="list-style-type: none"> ► Pull over and stop the vehicle, paying attention to road and traffic conditions. ► Secure the vehicle against rolling away. ► Consult a qualified specialist workshop.
<p> Red warning lamp lights up while the engine is running.</p> <p>Warning tone sounds.</p> <p>Colour display: Brake force distribution inoperative. Stop See Owner's Manual appears.</p>	<p>EBD is malfunctioning. This means that ABS, ESP[®], Crosswind Assist and Hill start assist are also unavailable.</p> <p>Other driving systems may be deactivated.</p> <p> WARNING</p> <p>The brake system continues to function normally, but without the functions listed above. The wheels could therefore lock early if you brake hard, for example.</p> <p>The steerability and braking characteristics may be severely affected. The braking distance may increase in emergency braking situations.</p> <p>If ESP[®] is not operational, the vehicle will not be stabilised by ESP[®].</p> <p>The danger of skidding and having an accident increases.</p> <ul style="list-style-type: none"> ► Pull over and stop the vehicle, paying attention to road and traffic conditions. ► Secure the vehicle against rolling away. ► Consult a qualified specialist workshop.

Problem	Possible causes/consequences and ► Solutions
<p> Monochrome display: yellow warning lamp lights up while the engine is running.</p> <p> Colour display: yellow warning lamp lights up.</p> <p>System inoperative appears.</p>	<p>ESP® is not available due to a malfunction. Other driving systems may be deactivated.</p> <p> WARNING</p> <p>If ESP® is malfunctioning, ESP® is unable to stabilise the vehicle. In addition, other driving safety systems are switched off. This increases the risk of skidding and an accident.</p> <p>Drive on carefully. Have ESP® checked at a qualified specialist workshop.</p> <p>Brake lamps may be inoperative and thus no longer working when braking.</p> <ul style="list-style-type: none"> ► Pull over and stop the vehicle, paying attention to road and traffic conditions. Do not drive on. ► Check that the brake lamps are working. <p>The brake lamps are not working.</p> <ul style="list-style-type: none"> ► Consult a qualified specialist workshop. <p>Brake lamps are working.</p> <ul style="list-style-type: none"> ► Drive on carefully. ► Consult a qualified specialist workshop.
<p> Colour display: yellow warning lamp lights up.</p> <p>Brake Assist System (BAS) inoperative appears.</p>	<p>The Brake Assist System (BAS) is inoperative.</p> <ul style="list-style-type: none"> ► Consult a qualified specialist workshop.
<p> Yellow warning lamp flashes while driving.</p>	<p>ESP® is intervening because there is a risk of skidding or at least one of the wheels is spinning.</p> <ul style="list-style-type: none"> ► Pull away carefully. ► Accelerate carefully whilst driving. ► Adapt your driving style to suit the road and weather conditions.
<p> and  and other warning lamps are lit.</p> <p>Colour display: Electronics malfunction Visit workshop appears.</p>	<p>Central vehicle electronics system is malfunctioning.</p> <p>After switching off the engine, it is no longer possible to lock or unlock the doors using the remote control on the key or to start the engine.</p> <ul style="list-style-type: none"> ► Pull over and stop the vehicle, paying attention to road and traffic conditions. ► Consult a qualified specialist workshop.



Problem	Possible causes/consequences and ► Solutions
<p>Colour display:  Hill start assist inoperative appears.</p>	<p>Hill start assist is malfunctioning. Vehicle will not be held automatically when pulling away uphill and may start rolling immediately.</p> <p> WARNING</p> <p>If ESP® is malfunctioning, ESP® is unable to stabilise the vehicle. In addition, other driving safety systems are switched off. This increases the risk of skidding and an accident.</p> <p>Drive on carefully. Have ESP® checked at a qualified specialist workshop.</p> <p>Other driving systems may be deactivated.</p> <p>The brake system functions normally, but without hill start assist.</p> <ul style="list-style-type: none"> ► Drive on carefully. ► Consult a qualified specialist workshop.
<p> Yellow warning lamp lights up while driving.</p> <p>Colour display: Correct tyre pressure appears.</p>	<p>The tyre pressure is too low in at least one of the tyres, or the tyre pressure difference between the wheels is too great.</p> <ul style="list-style-type: none"> ► Check tyre pressure. ► Correct the tyre pressure. ► Restart tyre pressure monitor.



Problem	Possible causes/consequences and ► Solutions
<p> Yellow warning lamp lights up while driving.</p> <p>Colour display: Tyre pressure Caution tyre malfunction appears.</p>	<p>The tyre pressure monitor has detected a significant loss of pressure in at least one of the tyres.</p> <p> WARNING</p> <p>Underinflated or overinflated tyres pose the following risks:</p> <ul style="list-style-type: none"> • the tyres may burst, especially as the load and vehicle speed increase. • the tyres may wear excessively and/or unevenly, which may greatly impair tyre traction. • the driving characteristics, as well as steering and braking, may be greatly impaired. <p>There is a risk of an accident.</p> <p>Observe the recommended tyre pressure and check the tyre pressure of all the tyres:</p> <ul style="list-style-type: none"> • at least every two weeks • when the load changes • before embarking on a longer journey • for changed operating conditions, e.g. off-road driving <p>If necessary, correct the tyre pressure.</p> <ul style="list-style-type: none"> ► Secure the vehicle against rolling away. ► Check tyres visually and, if necessary, follow the instructions for flat tyres. ► Check the tyre pressure and correct it if necessary.
<p> Yellow warning lamp flashes for approximately one minute and then stays lit.</p> <p>Colour display: Tyre pressure monitor inoperative appears.</p>	<p>The tyre pressure monitor is malfunctioning or was not restarted after a wheel change.</p> <p> WARNING</p> <p>If you correct the tyre pressure without recalibrating the Run Flat Indicator, the system cannot issue a warning about a defective tyre in time. In the event of tyre pressure loss, the driving characteristics and the steering and braking may be greatly impaired. There is a risk of an accident.</p> <p>If you correct the tyre pressure, you must recalibrate the Run Flat Indicator.</p> <ul style="list-style-type: none"> ► Restart tyre pressure monitor. <p>The display message continues to be displayed.</p> <ul style="list-style-type: none"> ► Drive on carefully. ► Consult a qualified specialist workshop.









Problem	Possible causes/consequences and ► Solutions
<p> Yellow warning lamp flashes for approximately 60 seconds and then remains lit.</p> <p>Colour display: Tyre pressure monitor inoperative wheel sensors missing appears.</p>	<p>There is no signal from the tyre pressure sensor of one or more wheels.</p> <p> WARNING</p> <p>Risk of accident due to undetected tyre pressure losses. The system is possibly unable to recognise or register low tyre pressure.</p> <p>► Consult a qualified specialist workshop.</p> <hr/> <p>Wheels have unsuitable tyre pressure sensors.</p> <p>► Fit wheels with suitable tyre pressure sensors.</p>
<p> Red warning lamp is lit.</p> <p>,  yellow warning lamps light up while the engine is running.</p> <p>Warning tone sounds.</p> <p>Colour display: Electronics malfunction Stop See Owner's Manual appears.</p>	<p>The following systems are malfunctioning:</p> <ul style="list-style-type: none"> • ABS (anti-lock braking system) • ESP® (Electronic Stability Program) • Crosswind Assist • Hill start assist <p>Further driving systems could be switched off automatically.</p> <p> WARNING</p> <p>The risk of skidding and having an accident increases due to malfunctioning driving safety systems.</p> <p>The brake system functions normally, but without the systems listed. The wheels could therefore lock if you brake hard, for example.</p> <p>This will greatly impair the ability to steer and brake. The braking distance may increase in emergency braking situations.</p> <p>► Pull over and stop the vehicle, paying attention to road and traffic conditions.</p> <p>► Consult a qualified specialist workshop.</p>

Problem	Possible causes/consequences and ► Solutions
<p>Monochrome display:  yellow warning lamp lights up while the engine is running.</p>	<p>Power assistance may be malfunctioning, making steering difficult.</p> <p> WARNING</p> <p>You will need to use more force to steer. There is a risk of an accident.</p> <p>► Check whether you are able to apply the extra force required.</p> <p>If you are able to steer safely:</p> <p>► Drive on carefully. ► Visit a qualified specialist workshop immediately.</p> <p>If you are unable to steer safely:</p> <p>► Do not drive on. ► Consult a qualified specialist workshop.</p>
<p> Yellow warning lamp lights up while the engine is running.</p> <p>Colour display: Steering malfunction See Owner's Manual or Electronics malfunction See Owner's Manual appears.</p>	<p>Power assistance may be malfunctioning, making steering difficult.</p> <p> WARNING</p> <p>You will need to use more force to steer. There is a risk of an accident.</p> <p>► Check whether you are able to apply the extra force required.</p> <p>If you are able to steer safely:</p> <p>► Drive on carefully. ► Visit a qualified specialist workshop immediately.</p> <p>If you are unable to steer safely:</p> <p>► Do not drive on. ► Consult a qualified specialist workshop.</p>







Driver assistance systems





Problem	Possible causes/consequences and ► Solutions
<p> Red warning lamp is lit. Warning tone sounds.</p>	<p>Collision warning detects an obstacle on the road.</p> <p>► Pay careful attention to the road and traffic conditions and be ready to brake.</p>
<p> Red warning lamp is lit.</p>	<p>Distance to the vehicle in front is too short for the current speed.</p> <p>► Increase the distance.</p>
<p> Yellow warning lamp lights up while driving.</p> <p>Colour display: Active Brake Assist inoper-</p>	<p>The sensors in the radiator trim are dirty.</p> <p>► Clean the sensors.</p>

Problem	Possible causes/consequences and ► Solutions
<p>Active or Electronics malfunction Visit workshop appears.</p>	<p>Environmental influences or error sources outside the system are temporarily interfering with Active Brake Assist and radar-assisted recuperation. Possible causes:</p> <ul style="list-style-type: none"> • heavy rain or snow • operating temperature is too high • on-board voltage is too low <p>Active Brake Assist is automatically operational again when the causes listed no longer apply.</p> <p>Warning lamp remains lit:</p> <ul style="list-style-type: none"> ► Pull over and stop the vehicle, paying attention to road and traffic conditions. ► Clean the sensors. ► Restart the engine. <p>Warning lamp still remains lit:</p> <ul style="list-style-type: none"> ► Consult a qualified specialist workshop.
<p> and  as well as other warning lamps are lit.</p>	<p>Central vehicle electronics system is malfunctioning.</p> <p>After switching off the engine, it is no longer possible to lock or unlock the doors using the remote control on the key or to start the engine.</p> <ul style="list-style-type: none"> ► Pull over and stop the vehicle, paying attention to road and traffic conditions. ► Consult a qualified specialist workshop.
<p> flashes for approximately three seconds.</p> <p>Warning tone sounds.</p> <p>Colour display: Lane Keeping Assist inoperative appears.</p>	<p>Windscreen is dirty in the camera's field of vision.</p> <ul style="list-style-type: none"> ► Pull over and stop the vehicle, paying attention to road and traffic conditions. ► Clean the windscreen. <p>Environmental influences are interfering with Lane Keeping Assist. Possible causes:</p> <ul style="list-style-type: none"> • heavy rain or snow or thick fog is impairing visibility • the sun is low in the sky and shining directly onto the sensor • lane markings cannot be detected <p>Lane Keeping Assist is automatically operational again when the causes listed no longer apply.</p> <p>If the windscreen is clean and the causes listed do not apply, then the electronics are malfunctioning.</p> <p>System electronics are faulty.</p> <ul style="list-style-type: none"> ► Consult a qualified specialist workshop.

Problem	Possible causes/consequences and ► Solutions
 flashes for a maximum of five seconds. Colour display: the green  warning lamp flashes for a maximum of five seconds. Warning tone sounds.	A lane boundary marking was crossed without using the turn signal. ► Stay inside the lane boundary markings. ► Use indicator before changing lanes.
 flashes for approximately ten seconds. Warning tone sounds. Colour display:  Cruise control inoperative appears.	Cruise control is malfunctioning and deactivates automatically. ► Consult a qualified specialist workshop.
 flashes for approximately ten seconds.  and other warning lamps are also lit. Warning tone sounds. Colour display: Electronics malfunction Visit workshop appears.	Central vehicle electronics system and cruise control are malfunctioning. After switching off the engine, it is no longer possible to lock or unlock the doors using the remote control on the key or to start the engine. ► Pull over and stop the vehicle immediately, paying attention to road and traffic conditions. ► Consult a qualified specialist workshop.
 lights up. Speed display flashes. Warning tone sounds.	Vehicle is exceeding the set limit speed. ► Brake the vehicle, paying attention to road and traffic conditions.
 flashes for approximately ten seconds. Warning tone sounds. Colour display: Limit inoperative appears.	Speed limiter is malfunctioning and deactivates automatically. ► Consult a qualified specialist workshop.
 warning lamp flashes for a minute or lights up continuously. Colour display: Black ice warning appears.	The outside temperature has fallen to or below 3 °C. There is a risk of black ice. ► Adapt your driving style and speed to suit the weather conditions.

Battery, lights, heating

Problem	Possible causes/consequences and ► Solutions
Rear window heating or seat heating switches off automatically or cannot be switched on.	Battery is not sufficiently charged. ► Switch off electrical consumers that are not required.
 Yellow warning lamp lights up. Battery reserve level appears.	The charge status of the high-voltage battery has dropped into the reserve range. ► Charge the high-voltage battery.
Monochrome display:  Yellow warning lamp flashes. Colour display:  Yellow warning lamp lights up. Battery reserve level appears.	Charge status of the high-voltage battery is below 10 %. ► Charge the high-voltage battery.
 Display flashes. The vehicle has switched itself off. Battery charge too low Charge HV battery now appears.	The vehicle has switched itself off because the charge status of the high-voltage battery is too low. After restarting the vehicle, depending on the charge status of the high-voltage battery, the vehicle can only drive on a maximum of 1 km. ► Park the vehicle paying attention to road and traffic conditions. ► Charge the high-voltage battery.
 Red warning lamp lights up when driving or when the vehicle is ready to start. Warning tone sounds. Colour display: Stop See Owner's Manual appears.	12 V battery is not being charged or the high-voltage battery is malfunctioning. ► Do not drive on. The engine may switch itself off after a short while. ► Pull over and stop the vehicle, paying attention to road and traffic conditions. ► Switch off the engine. ► Consult a qualified specialist workshop. It may not be possible to drive the vehicle further and it may not be possible to restart the engine.
Colour display:  Warning lamp lights up. Malfunction Visit workshop appears.	Battery monitoring is malfunctioning. ► Consult a qualified specialist workshop.
Monochrome display:  Warning lamp lights up.	Dipped beam is on continuously. Main beam cannot be activated. ► Switch off the engine. ► Start the engine.

Problem	Possible causes/consequences and ► Solutions
	<p>Warning lamp remains lit. Brake lamps are inoperative. The bulb or LED is faulty.</p> <p> WARNING</p> <p>Risk of accident due to faulty brake lamps. The brake lamps are faulty and no longer alert other road users when braking.</p> <ul style="list-style-type: none"> ► Pull over and stop the vehicle, paying attention to road and traffic conditions. ► Consult a qualified specialist workshop. <hr/> <p>Warning lamp still remains lit. Rain/light sensor is malfunctioning.</p> <ul style="list-style-type: none"> ► Manually adjust exterior lighting. ► Manually adjust windscreen wipers. ► Consult a qualified specialist workshop.
<p>Colour display:  Warning lamp lights up. Malfunction See Owner's Manual appears.</p>	<p>Dipped beam is on continuously. Main beam cannot be activated.</p> <ul style="list-style-type: none"> ► Switch off the engine. ► Restart the engine. <hr/> <p>Warning lamp remains lit. Rain/light sensor is malfunctioning.</p> <ul style="list-style-type: none"> ► Manually adjust exterior lighting. ► Manually adjust windscreen wipers. ► Consult a qualified specialist workshop.
<p>Colour display:  Warning lamp lights up. Brake lamps inoperative appears.</p>	<p>Brake lamps are inoperative. The bulb or LED is faulty.</p> <p> WARNING</p> <p>Risk of accident due to faulty brake lamps. The brake lamps are faulty and no longer alert other road users when braking.</p> <ul style="list-style-type: none"> ► Pull over and stop the vehicle, paying attention to road and traffic conditions. ► Consult a qualified specialist workshop.
<p>Colour display: Switch off lights appears. Warning tone sounds.</p>	<p>Lights are still switched on when you leave the vehicle.</p> <ul style="list-style-type: none"> ► Turn control knob for the lights to AUTO or 0.

smart Audio-System and smart Media-System

Bluetooth® connection

Problem	Possible causes/consequences and ► Solutions
Bluetooth® connection cannot be established between the smart Audio-System or smart Media-System and mobile phone.	<ul style="list-style-type: none"> ► Ascertain whether the mobile phone is compatible with the system. Information about compatible mobile phones: www.smart.com/connect ► Check the security settings on your mobile phone. ► Check that the Bluetooth® function is enabled on the smart Audio-System or smart Media-system and on your mobile phone. ► Start the device search on the smart Audio-System or smart Media-System and on the mobile phone.

Navigation system in the smart Media-System

Problem	Possible causes/consequences and ► Solutions
No map is displayed in the navigation system.	<p>The SD card with the map data is missing or damaged.</p> <ul style="list-style-type: none"> ► Check to see that the SD card is inserted.
Position of the vehicle in the navigation system does not match the vehicle's actual position. GPS symbol on the display is grey or yellow.	<p>GPS reception is poor.</p> <ul style="list-style-type: none"> ► Drive the vehicle to another position where GPS reception is better.
The road's course in the navigation system no longer coincides with the actual road.	<p>The map data is out of date.</p> <ul style="list-style-type: none"> ► Update the map data.
Navigation system does not display any traffic information.	<p>Route guidance has not been started.</p> <ul style="list-style-type: none"> ► Select a destination and start navigation. <p>HD Traffic is not available or the subscription for HD Traffic has expired.</p> <ul style="list-style-type: none"> ► Check whether HD Traffic is available for the country you are in or upgrade the subscription for HD Traffic.
There are no navigation messages during route guidance.	<p>The road's course is not detected. The map data may be out of date.</p> <ul style="list-style-type: none"> ► Check if route guidance has started. ► If not, select a destination and start navigation. <p>Navigation messages are switched off.</p> <ul style="list-style-type: none"> ► Switch on navigation messages.

Voice control system in the smart Media-System

Problem	Possible causes/consequences and ► Solutions
The voice control system does not understand voice commands.	<p>The interval for entering voice commands has been exceeded.</p> <p>► Press the  button on the multifunction steering wheel.</p>
	<p>Voice commands have not been given from the driver's seat.</p> <p>► Issue voice commands from the driver's seat.</p>
	<p>Noise from the blower or wind noise are interfering with voice commands.</p> <p>► Avoid interfering noises.</p>
	<p>Voice commands have not been given clearly.</p> <p>► Speak clearly when giving voice commands.</p>
	<p>A voice command is unknown.</p> <p>► Enter voice command "Help".</p> <p>A list of possible voice commands appears.</p>

Obtaining technical data

Information on technical data:
www.smart.de

The technical data was determined in accordance with EC Directives. All data applies to the vehicle's standard equipment. Differences will be present in the case of vehicles with optional equipment. Further information is available from any smart Centre.

Reading vehicle data

Useful information

Deviations from specified data:

- The heights and lengths specified vary as a result of:
 - tyres
 - load
 - condition of the suspension
 - optional equipment
- Items of optional equipment reduce the maximum payload
- Vehicle-specific weight information can be found on the vehicle identification plate
- Only for certain countries: you can find vehicle-specific vehicle data in the COC documents (EU CERTIFICATE OF CONFORMITY). These documents are delivered with your vehicle.

Vehicle identification plate

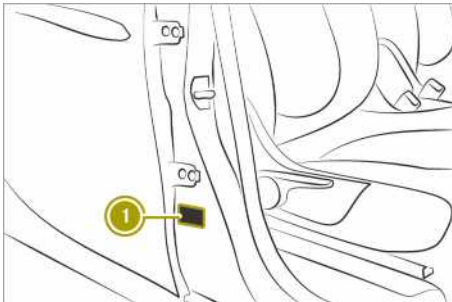

① Vehicle identification plate position

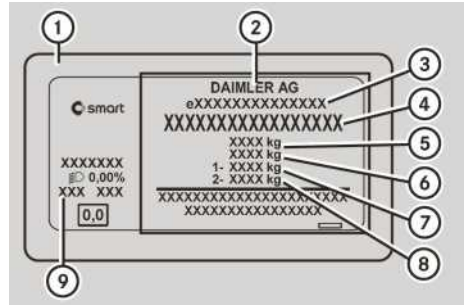

- ① Vehicle identification plate
- ② Vehicle manufacturer
- ③ EU type approval number
- ④ Vehicle identification number (VIN)
- ⑤ Maximum permissible gross weight
- ⑥ Maximum permissible gross weight of the vehicle combination
- ⑦ Maximum permissible front axle load
- ⑧ Maximum permissible rear axle load
- ⑨ Paint code

i The data shown on the vehicle identification plate is example data. This data is different for every vehicle and can deviate from the data shown here. The data applicable to the vehicle is found on the vehicle's identification plate.

Vehicle identification number (VIN)

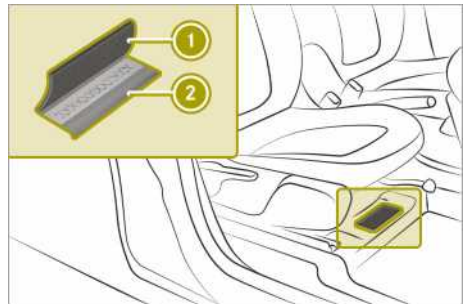

- ▶ Slide the right-hand front seat to its rearmost position.
- ▶ Fold floor covering ① upwards. VIN ② is located there.

The VIN can also be found on the vehicle identification plate.

Dimensions and weights

Missing technical data was not available at the time of going to print.

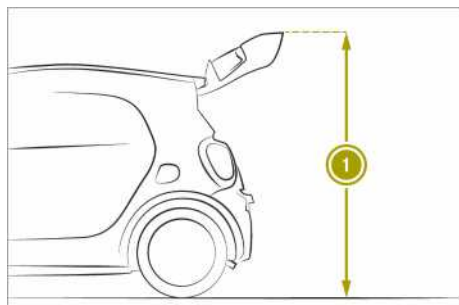

smart EQ forfour	Dimensions and weights
Opening height ①	2012 mm
Vehicle length	3495 mm
Vehicle width including exterior mirrors	1875 mm
Vehicle width excluding exterior mirrors	1665 mm
Vehicle width excluding exterior mirrors for vehicles equipped with wheel trims	
Vehicle height	1554 mm
Wheelbase	2494 mm
Maximum ground clearance	108 mm
Permissible roof load	0 kg

smart forfour crosstown edition	Dimensions, weights and volumes
Opening height ①	2012 mm
Vehicle length	3512 mm
Vehicle width including exterior mirrors	1875 mm
Vehicle width excluding exterior mirrors	1665 mm

smart forfour crosstown edition	Dimensions, weights and volumes
Vehicle width excluding exterior mirrors for vehicles equipped with wheel trims	
Vehicle height	1554 mm
Wheelbase	2494 mm
Maximum ground clearance	108 mm
Permissible roof load	

Charging time

i The options listed for charging a high-voltage battery are not available in all countries.

High-voltage battery	
Type	Lithium-ion
Vehicles with a 7 kW / 4.6 kW on-board charger	
Charging time (from 0% to 80%) at 32 A / 230 V	Approx. 2 h 30 min
Charging time (from 0% to 80%) at 20 A / 230 V	Approx. 3 h 30 min
Charging time (from 0% to 80%) at 10 A / 230 V	Approx. 7 h 30 min
Charging time (from 0% to 80%) at 8 A / 230 V	Approx. 9 h 30 min
Vehicles with a 22 kW on-board charger	
Charging time (from 0% to 80%) at 3x32 A / 230 V	Approx. 45 min

Charging cable	
Charging the battery at a charging station or wall box	
Nominal voltage	max. 400 V AC, max. 3-phase
Nominal frequency	50 Hz / 60 Hz
Nominal current	max. 32 A
Charge output	from 4.6 kW to 22 kW
System of protection	IP44 (inserted), IP24 (not inserted)
Outside temperature Observe the notes on maintaining the high- voltage bat- tery(> page 79)	-40 °C to +50 °C
Standards	IEC 61851-1, IEC 62196-1, IEC 62186-2
Interface	Type 2 to Type 2

Also observe the identification plate on the charging cable connector.

Service products

Please note

Also observe the information in the section "Checking and refilling service products" (> page 156).

Vehicle components and their respective service products must match. Therefore, only use products tested and approved by Mercedes-Benz.

Information on service products

The following table lists all technical data for the service products of the vehicle. Further information on service products: <http://>

bevo.mercedes-benz.com and in any smart centre.

Service products	Specifications
Corrosion inhibitor/antifreeze (> page 156)	Recommended: G40
Windscreen washer fluid (> page 157)	Temperatures above freezing point: mixing ratio of 1:100 MB SummerFit to water. Temperatures below freezing point: for the correct mixing ratio of MB WinterFit and water, please observe the information on the antifreeze container.

Bulb types

The following table lists the correct bulb types of the vehicle:

Bulb	Type
Dipped-beam/main-beam headlamps	H4 60/55 W
Front foglamps	H 16
Turn signals	PY 21 W
Side turn signal lamps	WY 5 W
Licence plate lighting	W 5 W
Interior lighting	W 5 W

Tail lamps

Bulb	Type
Tail lamp and brake lamp	P21 5 W
Rear foglamp	P21 W
Reversing lamp	W 16 W
Turn signals	PY 21 W

Fuse allocation

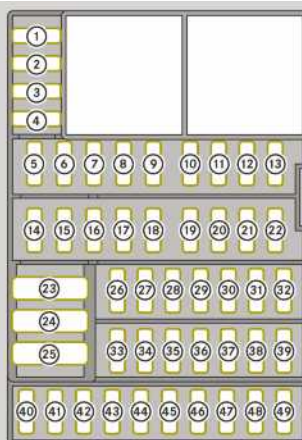

No.	Consumer	Current	Colour coding
1	Starter motor	5 A	Brown
2	Power steering control unit	5 A	Brown
3	Multifunction lever	5 A	Brown
4	Airbag	5 A	Brown
5	-	-	-
6	Instrument cluster	10 A	Red
7	Horn, alarm system	15 A	Blue
8	Power supply control unit	10 A	Red
9	Power supply control unit	10 A	Red
10	Central control unit	20 A	Yellow
11	Central control unit	15 A	Blue
12	Central control unit	10 A	Red
13	Central control unit	15 A	Blue
14	Power window switch (without reversing function)	30 A	Green
15	ESP®, transmission control unit	5 A	Brown
16	Interior lighting	10 A	Red
17	Immobiliser	3 A	Violet
18	Electrical exterior mirror	5 A	Brown

No.	Consumer	Current	Colour coding
19	Brake lamps	10 A	Red
20	Cruise control, radio, belt warning	15 A	Blue
21	Not for smart EQ fortwo, smart EQ fortwo cabrio, smart EQ forfour: central control unit, fuel pump, ignition system	15 A	Blue
22	Rear window wiper	15 A	Blue
23	Starter motor smart EQ fortwo, smart EQ fortwo cabrio, smart EQ forfour only: power supply control unit	40 A	Orange
24	-	-	-
25	Power supply control unit	30 A	Green
26	Radio	20 A	Yellow
27	Daytime driving lamps	5 A	Brown
28	12 V socket, cigarette lighter	15 A	Blue
29	Power supply control unit	5 A	Brown
30	Forward collision warning	15 A	Blue
31	-	-	-
32	Radio, central control unit	15 A	Blue
33	Tail lamps, front foglamps, hazard warning lamp button, locking button, headlamp range control, power windows, licence plate lighting, radio, control unit for heating or climate control system, cruise control, limiter, parking aid button, program selector button, tailgate release, Lane Keeping Assist camera, automatic start/stop system button	25 A	Cyan
34	Power supply control unit	25 A	Cyan
35	Headlamps, daytime driving lamps	25 A	Cyan
36 - 40	-	-	-
41	smart EQ forfour only: seat heating in the rear	15 A	Blue
42	smart EQ fortwo, smart EQ fortwo cabrio, smart EQ forfour only: seat heating in the front	25 A	Cyan
43	Mirror heating	5 A	Brown
44	Power windows (automatic reversing feature)	25 A	Cyan

No.	Consumer	Current	Colour coding
45	Transmission control unit smart EQ fortwo, smart EQ fortwo cabrio, smart EQ forfour only: EQ control unit	5 A	Brown
46	Radio amplifier	20 A	Yellow
47	-	-	-
48	smart EQ fortwo, smart EQ fortwo cabrio, smart EQ forfour only: vacuum pump	10 A	Red
49	smart EQ fortwo, smart EQ fortwo cabrio, smart EQ forfour only: heating control unit, air-condition- ing	10 A	Red

Radio type approvals for the tyre pressure monitors

Country	Radio type approval number
Argentina	MW2433A H-12337 GG4 H-12338
Brazil	2770-12-8001 Model: MW2433A 0381-13-8001 Model: GG4
Abu Dhabi Dubai	TRA, Registered-NO ER0092100/12 TRA, Registered-NO ER0099792/12 TRA, Registered-NO ER0076990/11 Dealer-NO: DA0047074/10

Country	Radio type approval number
Jordan	Model: Gen Alpha Wal 2 TPMS transmitter Type Approval Number: TRC/LPD/2012/114 Model: Gen Gamma Gen 4 433.92 MHz. Type Approval Number: TRC/LPD/2012/190 Model: Corax 3 MRXMC34MA4 Type Approval Number: TRC/LPD/2011/158 Type Number: LPD
Morocco	MR7319 ANRT 2012/ 11/07/2012 MR7672 ANRT 2012/ 23/11/2012 MR6706 ANRT 2011
Moldova	1024
Philippines	No: ESD-1206394C No: ESD-1306871C
Serbia	И 011 12
Singapore	Compliance with IDA Standard DA- 103365
South Africa	TA-2012/719 TA-2012/1540 TA-2011/1370

Installing two-way radios and mobile phones

WARNING

The electromagnetic radiation from two-way radios can interfere with the vehicle electronics if they are manipulated or retrofitted incorrectly. This could jeopardise the operating safety of the vehicle. There is a risk of an accident.

You should have all work on electrical and electronic components carried out at a qualified specialist workshop.

WARNING

If you operate two-way radios incorrectly in the vehicle, their electromagnetic radiation can interfere with the vehicle electronics, for example if:

- the two-way radio is not connected to an exterior aerial
- the exterior aerial is not correctly mounted or is not low-reflection

This could jeopardise the operating safety of the vehicle. There is a risk of an accident.

Have the low-reflection exterior aerial fitted at a qualified specialist workshop.

When operating two-way radios in the vehicle, always connect them to the low-reflection exterior aerial.

! Have the engine electronics and parts belonging to it such as control units, sensors, actuating components or electric cables maintained only at a qualified specialist workshop. Otherwise, vehicle components may wear more quickly and the vehicle's operating permit may be invalidated.

! The operating permit may be invalidated if the instructions for installation and use of two-way radios are not observed.

In particular, the following conditions must be complied with:

- only approved wavebands may be used
- observe the maximum permissible output in these wavebands
- only approved aerial positions may be used

Excessive levels of electromagnetic radiation can cause damage to health. The use of an exterior aerial takes into consideration the scientific discussion surrounding the possible health risk posed by electromagnetic fields.

The following aerial positions may be used for the correct installation of two-way radios:

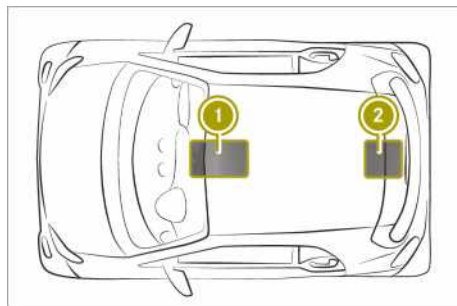

① Front roof area

② Rear roof area

i On vehicles with a folding top, fitting an aerial to the front roof area is not permitted.

Use Technical Specification ISO/TS 21609 (Road Vehicles – "EMC guidelines for installation of aftermarket radio frequency transmitting equipment") when retrofitting two-way radios. Comply with the legal requirements for add-on parts.

If your vehicle has fittings for two-way radio equipment, use the power supply and aerial connections intended for use in the basic wiring. Be sure to observe the manufacturer's additional instructions during installation.

Deviations with respect to wavebands, maximum transmission outputs or aerial positions must be approved by smart.

The maximum transmission output (PEAK) at the base of the aerial must not exceed the following values:

Waveband	Maximum transmission output
Tetra 380 - 410 MHz	20 W
Mobile communications generation 2G/3G/4G	6 W

The following can be used in the vehicle without restrictions:

- two-way radios with a maximum transmission output of up to 100 mW
- mobile phones (2G/3G/4G)

There are no restrictions when positioning the aerial on the outside of the vehicle for the following wavebands:

- tetra
- mobile communications (2G/3G/4G)

Publication details

Internet

Further information about smart vehicles and about Daimler AG can be found on the following websites:

<http://www.smart.com>

<http://www.daimler.com>

Editorial office

You are welcome to forward any queries or suggestions you may have regarding this Owner's Manual to the technical documentation team at the following address:

Daimler AG, HPC: CAC, Customer Service,
70546 Stuttgart, Germany

©Daimler AG: not to be reprinted, translated or otherwise reproduced, in whole or in part, without written permission from Daimler AG.

Vehicle manufacturer

Daimler AG
Mercedesstraße 137
70327 Stuttgart
Germany

Order no. 6522 0286 02
Part no. 453 584 68 14
Edition AJ2017-1c



Other ManualsLib Projects



www.manualslib.com



www.manualslib.de



www.manualslib.es



www.manualslib.fr



www.manualslib.nl



www.manualslib.mx



www.manualslib.tech 30+ Languages